

WOOD JOINTS IN CLASSICAL JAPANESE ARCHITECTURE

Torashichi Sumiyoshi Gengo Matsui



WOOD JOINTS
IN CLASSICAL JAPANESE ARCHITECTURE

Torashichi Sumiyoshi
Gengo Matsui

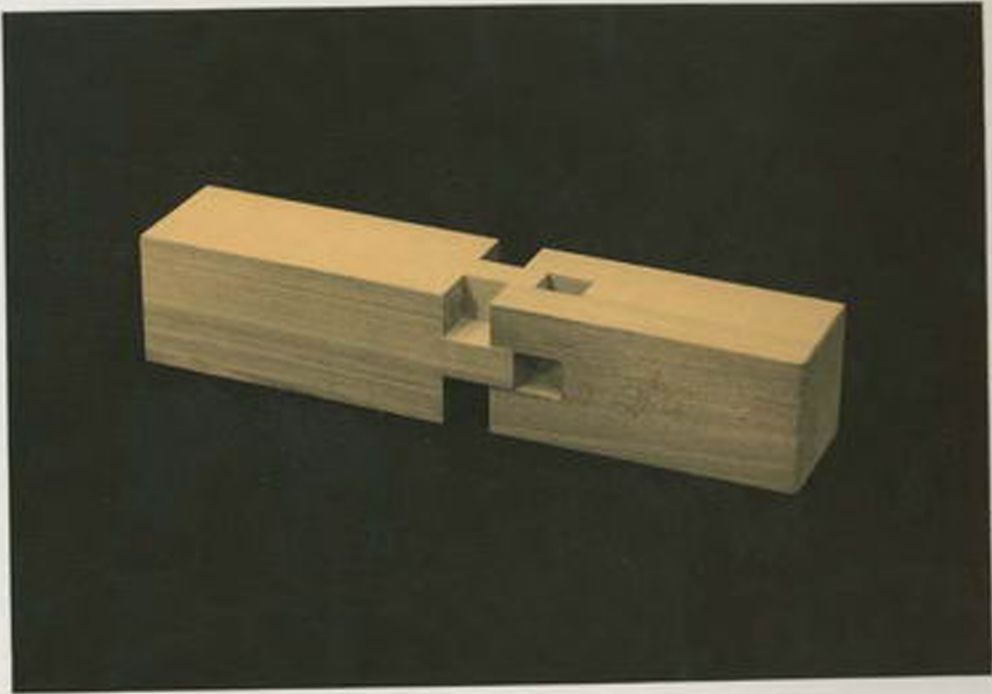

WOOD JOINTS IN CLASSICAL JAPANESE ARCHITECTURE

Torashichi Sumiyoshi

Gengo Matsui

Authors' Biographies:

Torashichi Sumiyoshi

- Date of birth 1911
- Begins carpentry apprenticeship in 1924
- Starts own enterprise in 1930
- Serves in navy 1944-1946
- Member of "Tenri Kyokai", involved in design and construction of temples
- Prepares wood shop drawings for Eishin Gakuen Higashino High School (1983-1985)

Gengo Matsui

- Date of birth 1920
- Graduates in Architecture from Waseda University 1943
- Receives Doctor of Engineering 1960
- Professor of Waseda University 1961
- Director of the Japanese Photoelastic Association 1979

WOOD JOINTS IN CLASSICAL JAPANESE ARCHITECTURE

© Torashichi Sumiyoshi and Gengo Matsui 1989

First Published in Japan by

Kajima Institute Publishing Co., Ltd.

Second printing, May 1990

English translation from the Japanese in

1991 by Ferenc Kovacs

Advisor André Gravel

Proofread and edited by Janos Nagy

Printed in Japan

WOOD JOINTS IN CLASSICAL JAPANESE ARCHITECTURE

Introduction by Yukihiro Kamiyama

Japanese architecture brings to mind stupendous Buddhist temples and shrines, plus the three- and five-story pagodas. Amongst these sacred places, one cannot help being overwhelmed by the radiance emanating from the structures. The purity of the lines leaves us in awe.

Master craftsmen, inspired by the beauty of the Japanese cypress and zelkova and influenced by the Japanese culture, produced these works of art.

Behind the beauty lies the skill and knowledge of an artisan. The harmony of the creation conceals the complexity of the assemblage. Simple elements, such as bearing blocks, all play a role in the final result.

There are many ways to join members together. Beams can be tied with ropes, carved and assembled or connected with nails, screws and glue. When these structures were erected, joining was an extremely elaborate technique. Master joiners were dedicated craftsmen responsible for splicing and connecting elements of a building. Many factors had to be considered. The connections had to be strong enough to transfer forces such as bending, torsion and shear, yet appearance was an important factor. A variety of techniques sometimes simple, sometimes elaborate were developed.

We can only marvel at the solutions adopted. They took into account time dependent process, such as shrinkage or slippage caused by dynamic loading. The intricacy of the internal structure of the joint is hidden by the apparent simplicity of its appearance. Various shapes connect into each other with ease. This wisdom is the result of years of patient work; we have much to learn from it.

Master Sumiyoshi and Professor Matsui met while working on the design and construction of Eishin Gakuen Higashino High School (architecture by Christopher Alexander). The school is famous for its large wooden structure, the first erected in Japan for many years.

Master Sumiyoshi contributed his experience and knowledge to the many splices and joints available to the builders. Professor Matsui, working as an advisor, was deeply impressed by Master Sumiyoshi's knowledge. Feeling his lifelong wisdom should not be lost, he planned this book to preserve a valuable heritage. It is to be of interest to students of wooden architecture and engineer-

ing worldwide.

The purpose of this book is mentioned in the authors' comments. Nowadays, joints are made using metal parts. The splices and connecting joints have become much simpler. It is now possible to construct large wooden structures using standard processes. However, the uncertain properties of wood have brought forward the problem of weakening of the joints.

This work goes back to the fundamental of joining. It is recommended to all technicians and also to architects and engineers.

Yukihiro Kamiyama
Professor, Waseda University

Authors' Comments

This book explains splices and connecting joints of traditional Japanese wooden architecture with pictures and diagrams. Although plenty of books have been published about splices and connecting joints, none of them have used both pictures and diagrams as illustrations. In most cases, pictures have only showed one or two examples of a joint and it is difficult to comprehend the complexity involved in joining the parts. Consequently, we decided to use several pictures and diagrams showing the sequence of assembly which will hopefully make the descriptions easier to follow. Dimensions have also been included, a feature not found in most other publications.

Our first objective is to ensure that traditional workmanship skills are accurately transferred to the next generation. Our predecessors accumulated the know-how necessary to achieve complex and effective design over the years. The intricacy of the joints enhance the character of the wood, bringing it alive. Many of these joints preserve the natural strength ratio carefully balancing shear, bending, torsion, compression and taking shrinkage into account.

Our second objective is to see whether these techniques can be utilized in contemporary architecture. This book describes the original characteristics of the joints. Some modifications might be required to make them effective for today's building technology. Bolts and modern adhesive could be used. The authors do not want to make such proposals; we leave it to the readers.

May, 1989
Torashichi Sumiyoshi
Gengo Matsui

Acknowledgement

We would like to thank Dr.Minoru Tezuka, Assistant at the Matsui Laboratory of Waseda University in Tokyo for his precious contribution to this work. Credit for the pictures, figures and diagrams goes to the Master degree students of the same Laboratory.

Special thanks to Mr. Kenichiro Uwaso for helping with editing and to all others who helped along the way.

We hereby express our gratitude.

Contents

Introduction by Yukihiro Kamiyama

Authors' Comments

Acknowledgment

SPLICING JOINTS1

- 01 Stepped dovetailed splice 2
- 02 Stepped gooseneck splice 5
- 03 Rabbeted oblique scarf splice 8
- 04 Mortised rabbeted oblique splice 11
- 05 Blind stubbed, housed rabbeted oblique scarf splice 15
- 06 Tenon and mortise splice 17
 - (1) Cross-shaped tenon and mortise splice
 - (2) Right angle tenon and mortise splice
 - (3) Housed tenon and mortise splice
 - (4) Blind tenon and mortise splice
- 07 Halved rabbeted oblique scarf splices 21
 - (1) Triple-faced halved rabbeted oblique scarf splice with key
 - (2) Miyajima splice
 - (3) Quadruple-faced halved rabbeted oblique scarf splice
- 08 Housed splices 26
 - (1) Housed rabbeted oblique scarf splice
 - (2) Blind tenon and mortise
 - (3) Blind pin
 - (4) Blind key
 - (5) Pole tenon
- 09 Column splices 36
 - (1) Four faces gooseneck splice
 - (2) Clam-shaped splice
 - (3) Blind splice

(4) Osaka Castle-Otemon Gate's pillar splice

CONNECTING JOINTS45

- 01 Half dovetailed joint 46
- 02 Wedging joint 48
- 03 Blind wedging joint 50
- 04 Housed dovetailed joint 52
- 05 Sumiyoshi double tenon 55
- 06 Double plug 58
- 07 Triple plug 62
- 08 Groundsill connectors 67
 - (1) Housed dovetail
 - (2) Rabbeted tenon and mortise
 - (3) Corner miter tenon
- 09 "Kyoro" system 72
- 10 "Orioku" system 76
- 11 Tie beam connector 80
- 12 Hip rafter joint 83
 - (1) Tee-shaped girder joint
 - (2) Cross-shaped girder joint
 - (3) Bevelled halving
- 13 Corridor girder 107

MISCELLANEOUS113

- 01 Gable board 114
 - (1) Ogami with encased crossbrace
 - (2) Ogami with surface crossbrace
 - (3) Ogami with stub tenon and key
- 03 Level 121
- 04 Batter post 122

Terminology 123

Contents

Introduction	1
Chapter 1: The Splicing Process	10
Chapter 2: Splicing Techniques	25
Chapter 3: Splicing Materials	40
Chapter 4: Splicing Equipment	55
Chapter 5: Splicing Safety	70
Chapter 6: Splicing Applications	85
Chapter 7: Splicing Maintenance	100
Chapter 8: Splicing Troubleshooting	115
Chapter 9: Splicing Quality Control	130
Chapter 10: Splicing Standards	145
Chapter 11: Splicing Research	160
Chapter 12: Splicing Future	175

SPLICING JOINTS

The right page of the book is mostly blank, with a dark grey background. A thin white horizontal line is visible near the top of the page, just below the title. The rest of the page is empty.

● SPLICE 01 ●

Stepped dovetailed splice

(Koshikake aritsugi)

This simple splice is utilized primarily to join groundsills. The most common lumber sections range from 105mm to 120mm square. The ends to be spliced are notched at half depth. The male is shaped like the tail of a dove, narrow at the girth then flaring out. The female is precisely hollowed

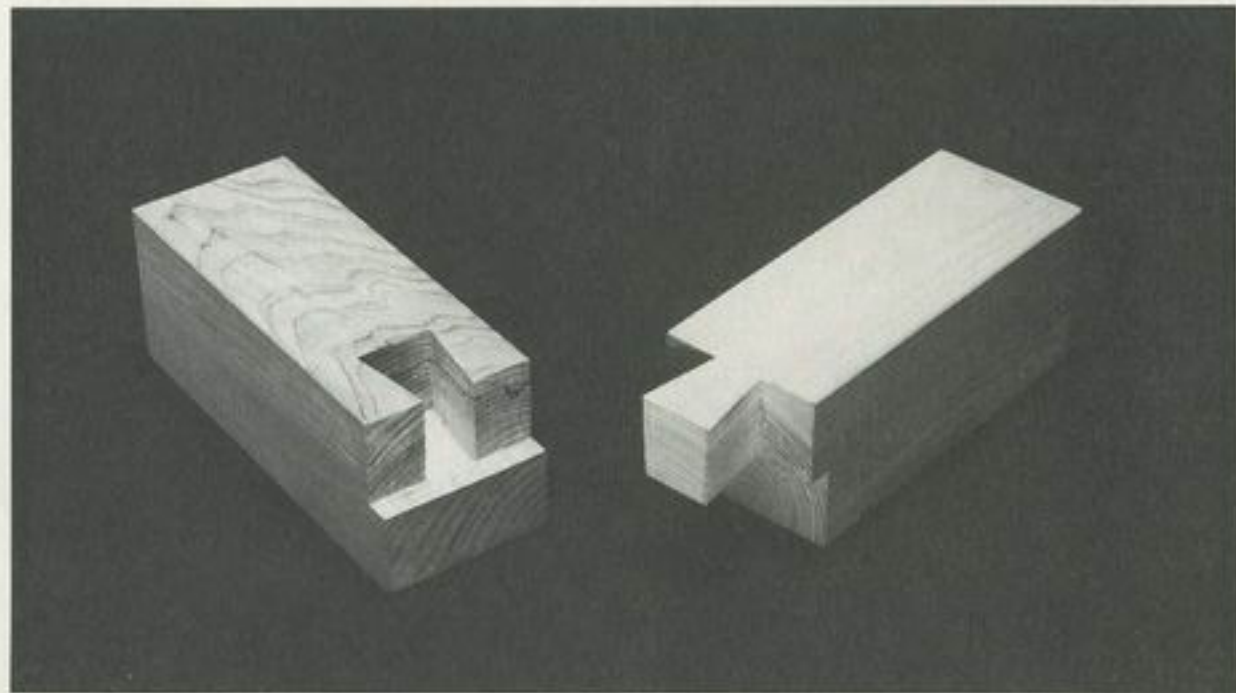
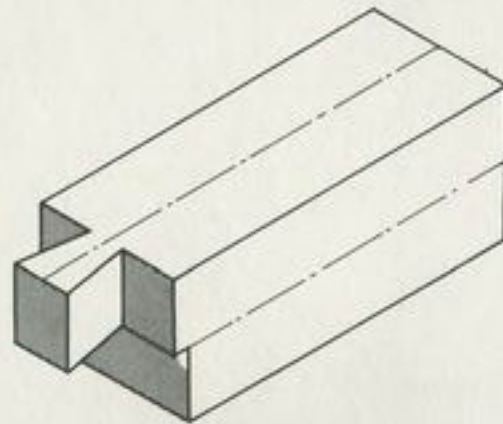
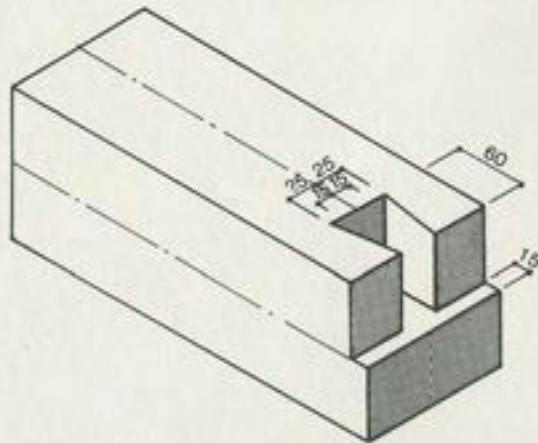

out to fit. A snug fit is a common characteristic of all joints. This joint is simply assembled by sliding the male into the female. No axial shifting is required. This feature makes this joint particularly useful on groundsills. Eventhough this splice aims to resist tension in a structure, its effective tensile strength is small.

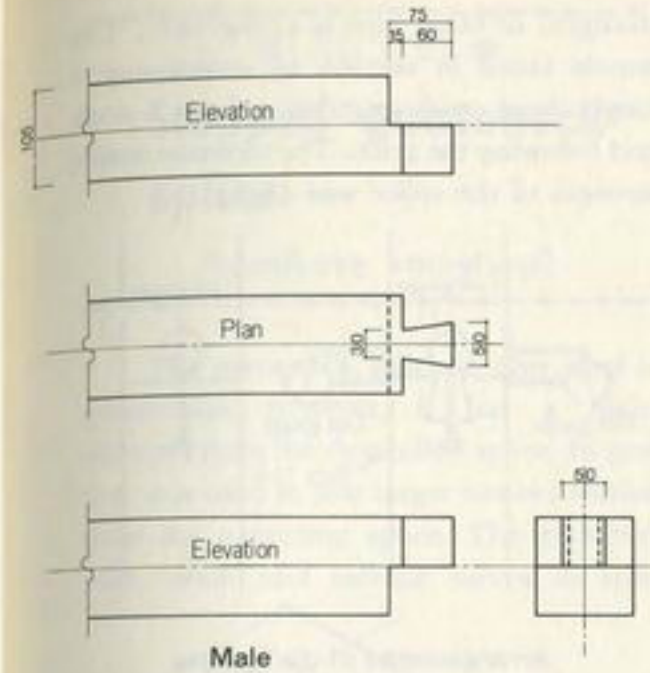

Male

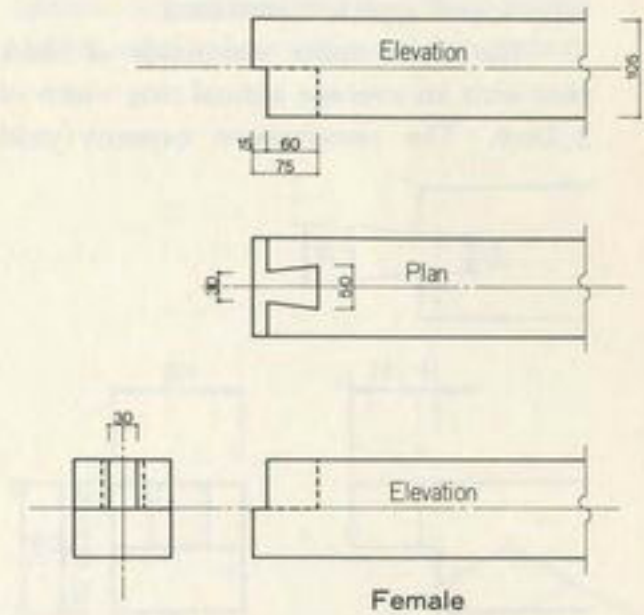

Female

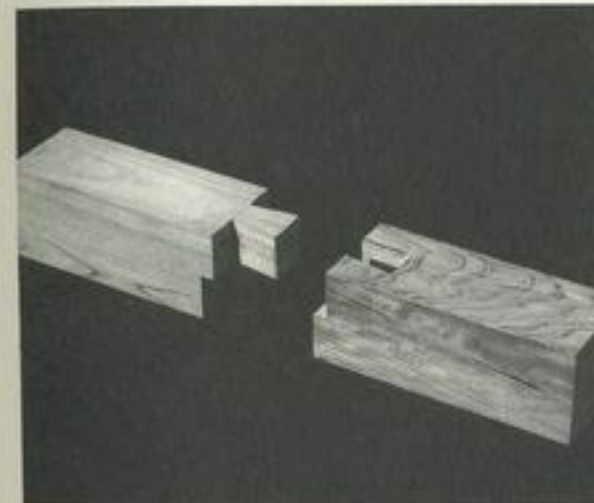

① Male and female

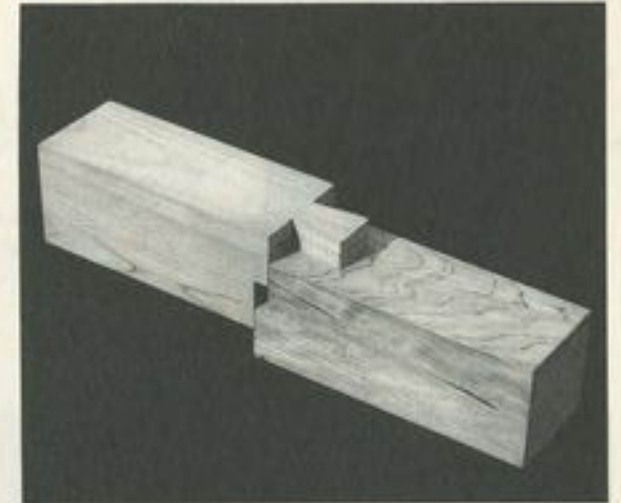

② The male slides into the female

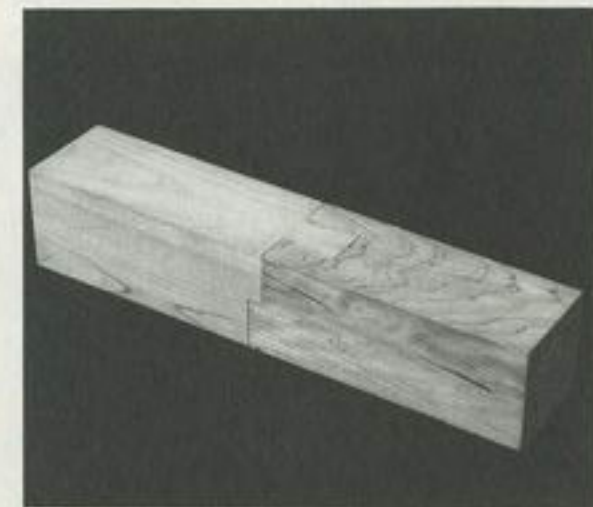

③ Assembled splice

A tension test was carried out on an assembly of typical dimensions.

The tested splice was made of black pine with an average annual ring width of 2.5mm. The compressive capacity (yield

strength) of black pine is 420kg/cm². The female failed in tension by developing a longitudinal crack originating from a nook and following the grain. The ultimate tensile strength of the splice was 480kg.

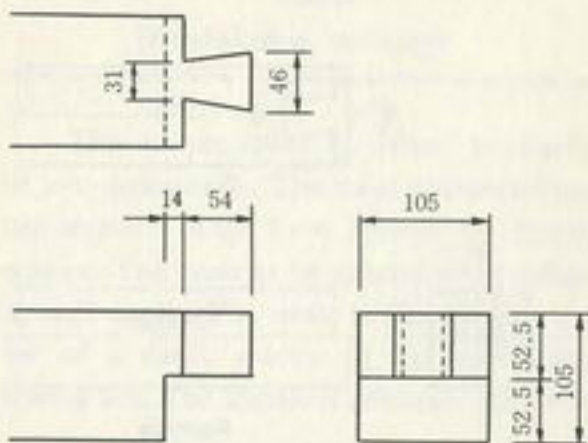

Test sample dimensions

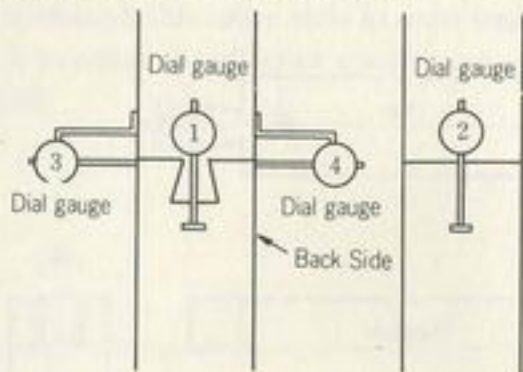

Arrangements of dial gauges

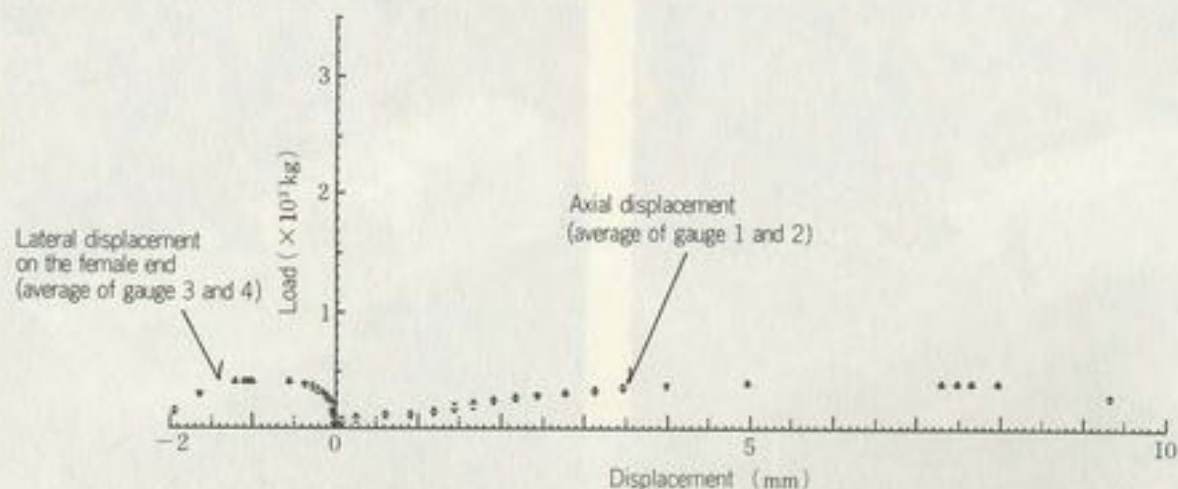

Load-displacement curve

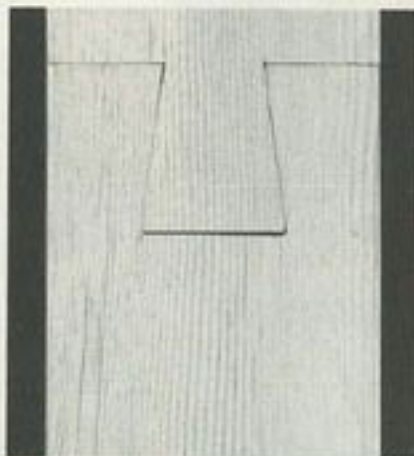

Before failure

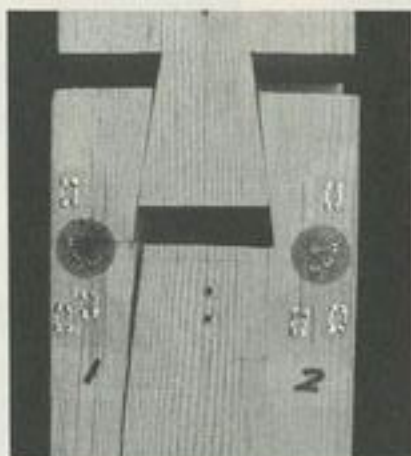

After failure

● SPLICE 02 ●

Stepped gooseneck splice

(Koshikake kamatsugi)

square section lumber between 150mm and 200mm. For sections of more than 200mm oblique scarf splices are more appropriate.

The gooseneck splice is also used on groundsills; however, it has a higher strength than the dovetailed splice. In practice, it is used to join larger lumber sections than the preceding splice. The gooseneck with tenon and mortise serves to splice

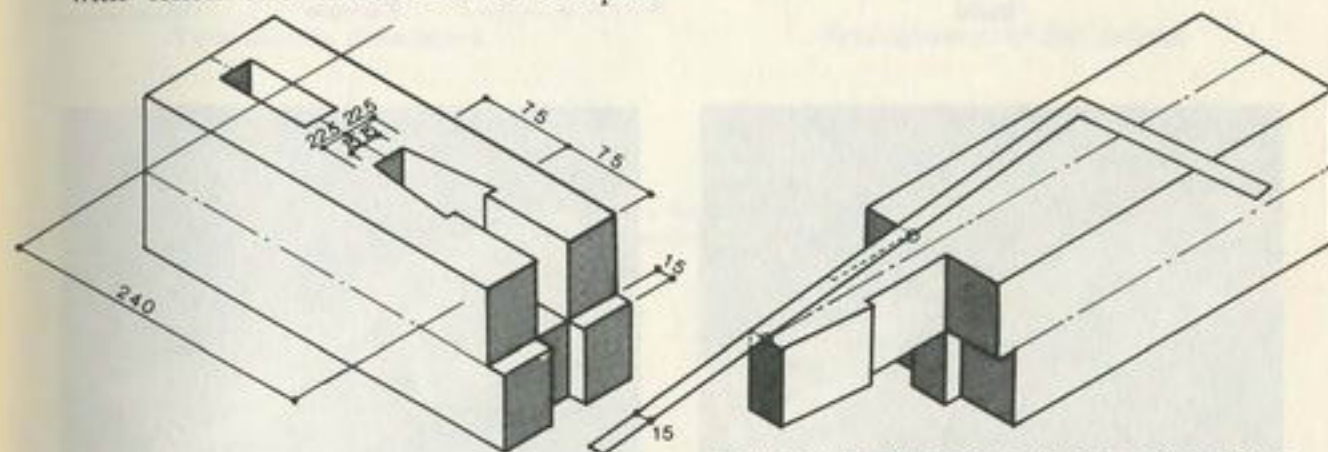

Test sample dimensions. Angular dimensions are shown on the next page.

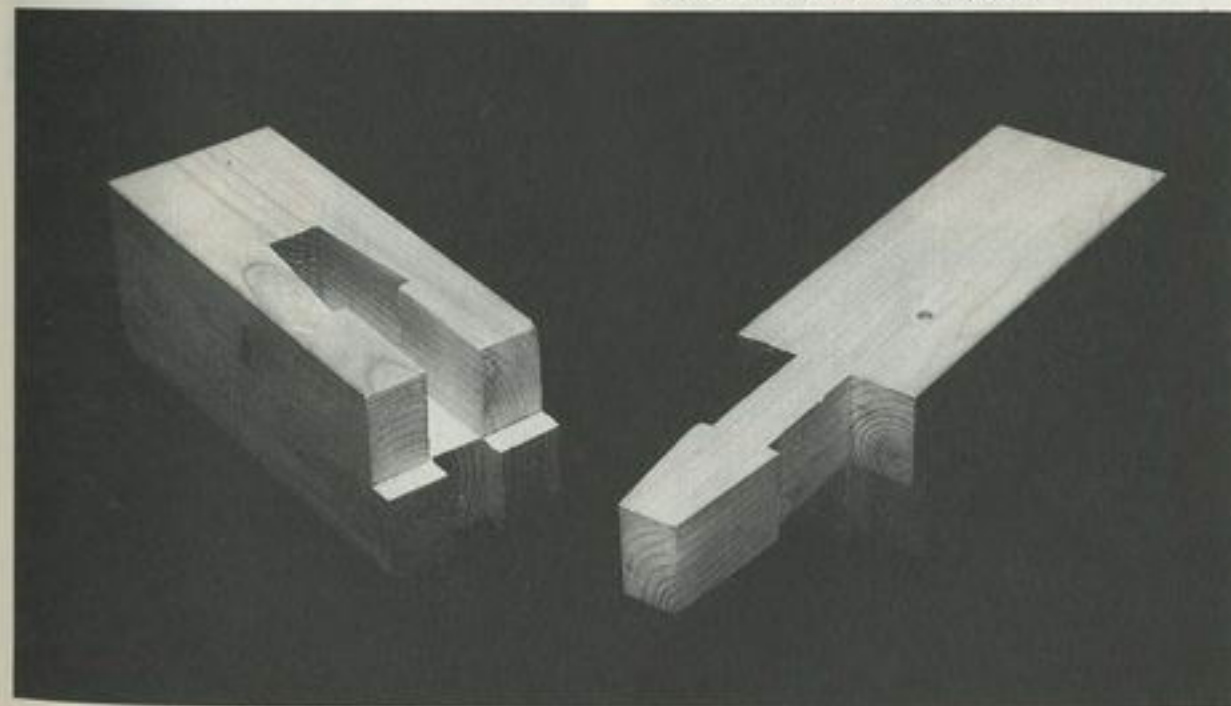

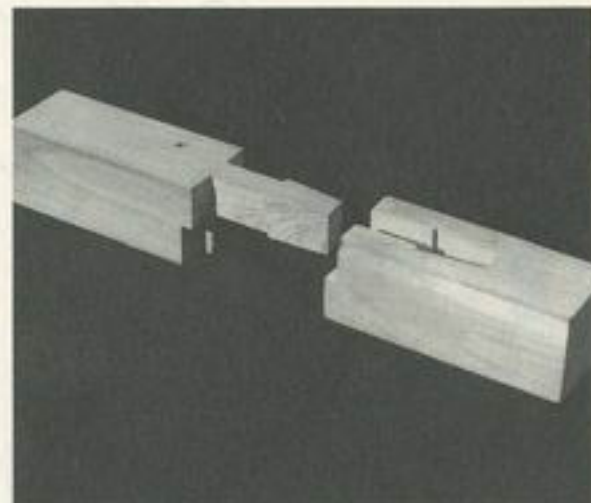
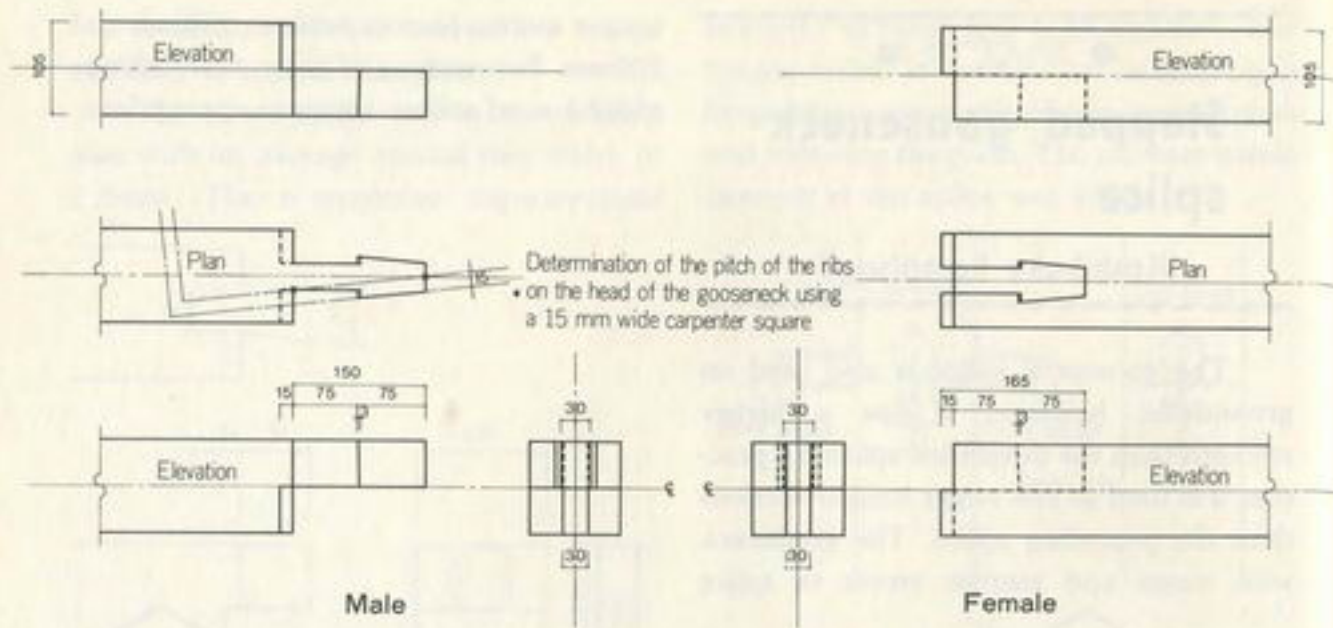

1 Male and female

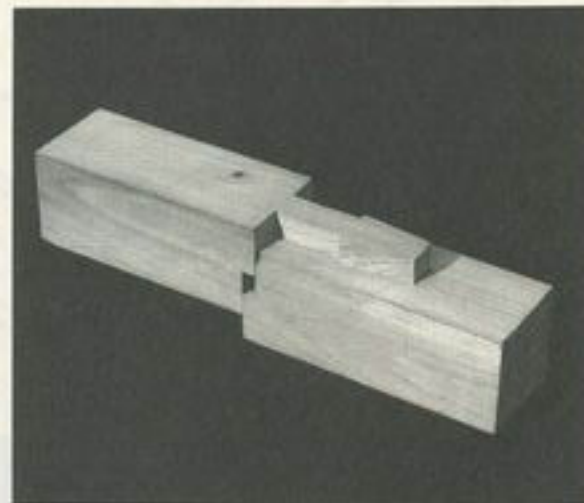

2 The male slides into the female

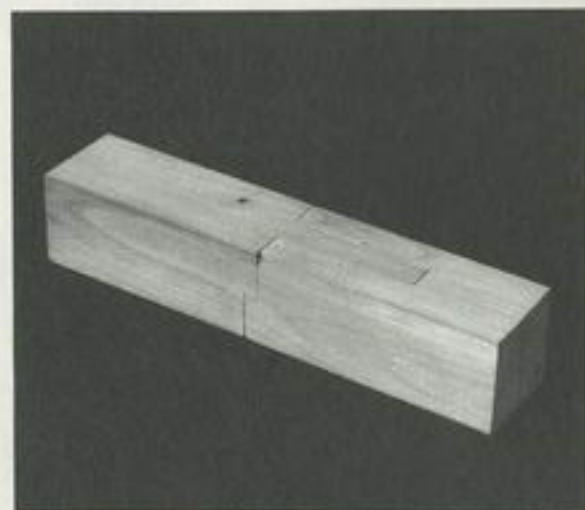

3 Assembled splice

The tensile test was performed on an assembly of the same size and material as for the dovetail splice. At ultimate strength, two modes of failure occurred. At first the joint failed in bearing, crushing the head of

the gooseneck against the abutments of the female end. The second mode involved the shearing of a rib at the head of the male end. The ultimate strength of the model tested was 2400kg, a significant increase in strength compared to the dovetailed splice.

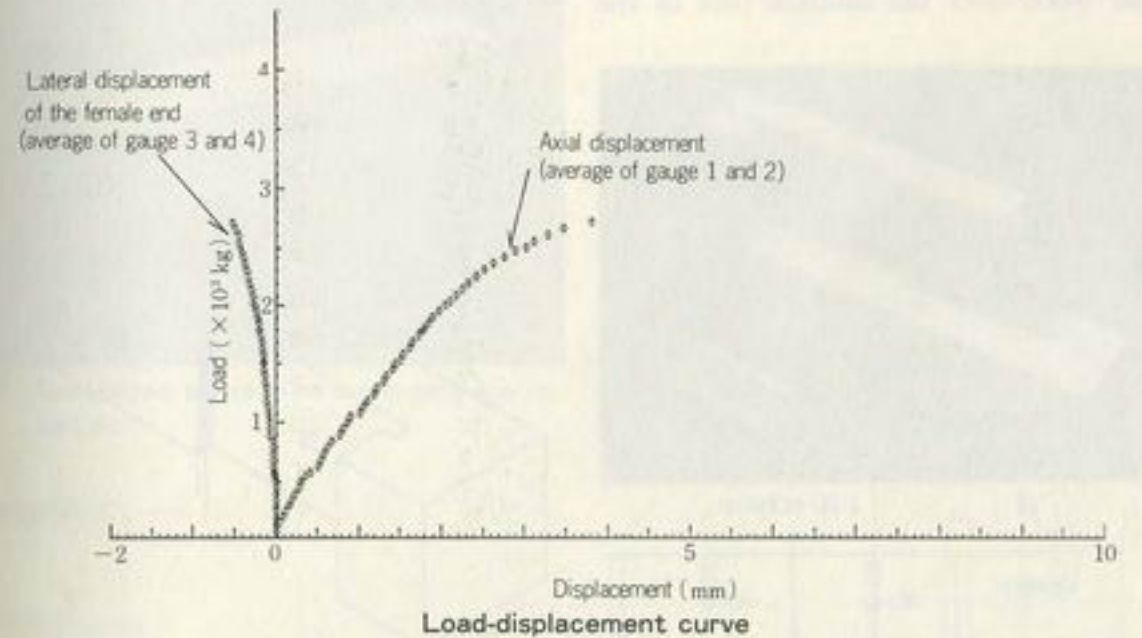
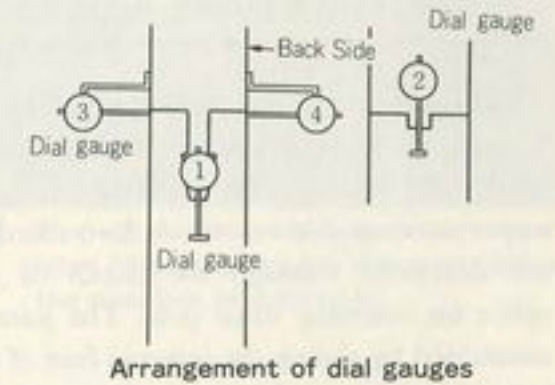
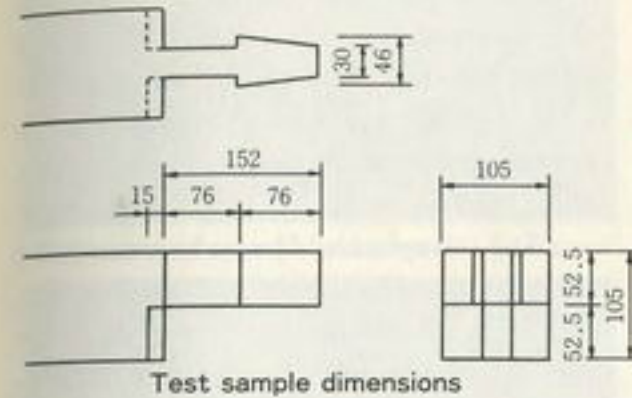

Load-displacement curve

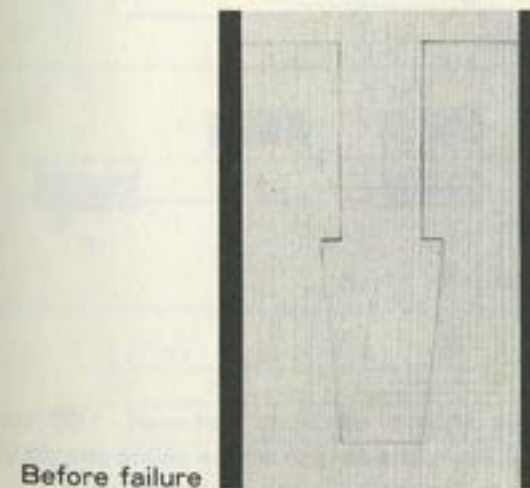

Before failure

- 1 Bearing failure mode
- 2 Shearing failure mode

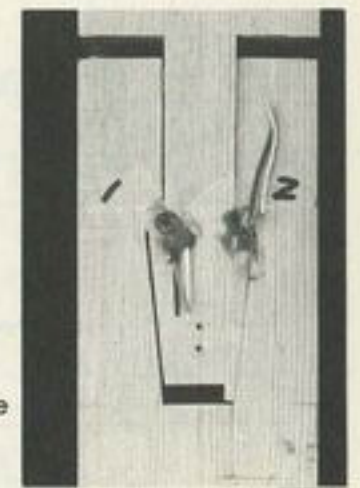

After failure

● SPLICE 03 ●

Rabbeted oblique scarf splice

(Okkake daisen tsugi)

This splice can be used to join ground-sills, girders or beams. The two ends of the joints are identical and referred to as the upper wood and lower wood. Two mortises are deepened through the depth of the splice for inserting draw pins. The joint is assembled by sliding the internal face of the upper wood over the internal face of the

lower wood, keeping the surfaces of the middle drops (surfaces "d") in close contact. The pieces are then pressed together and secured by pounding in two draw pins, effectively interlocking the front and back surfaces of the joint (surfaces "a"). The pins are inserted from the thicker end toward the thinner end, in an alternate fashion. Unlike other oblique scarf splices no axial shifting is required to assemble this splice, making it particularly suitable for installing or replacing a beam between fixed supports or a sill between anchored points. This rabbeted oblique scarf splice could be more appropriately called "pinned rabbeted oblique scarf splice".

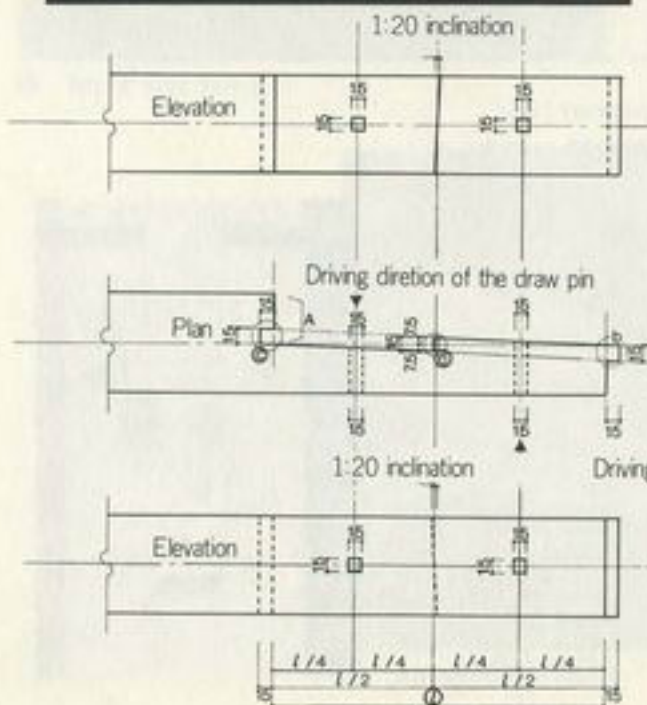
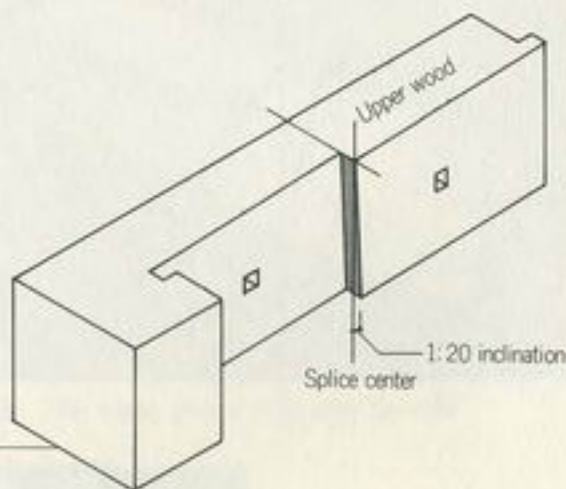
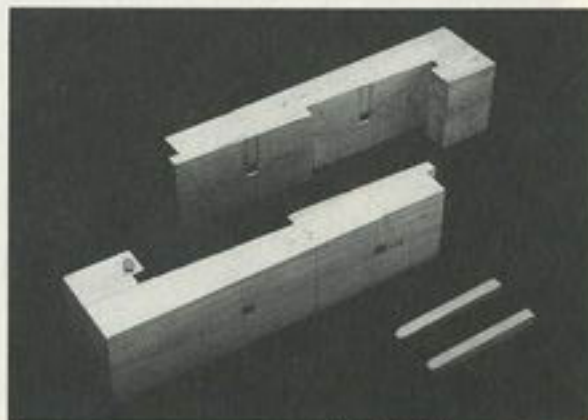

For square sections between 105mm to 120mm, the length of the splice should be 3 to 4 times the width of the section.

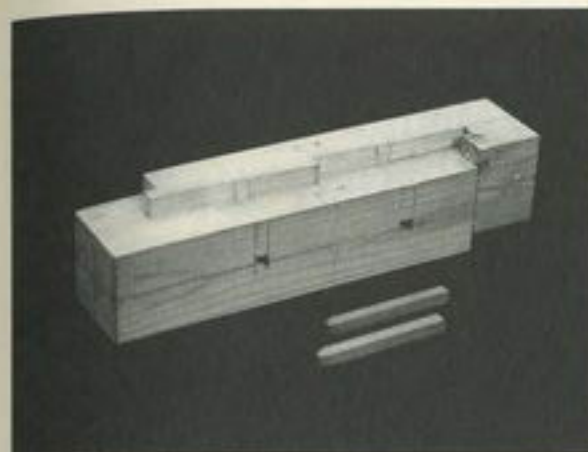

1 Upper wood and lower wood

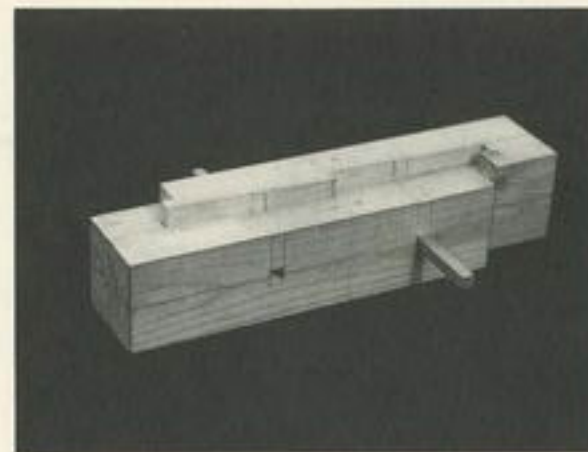

2 The upper wood slides over the lower wood (the draw pins are shown to display the direction of insertion).

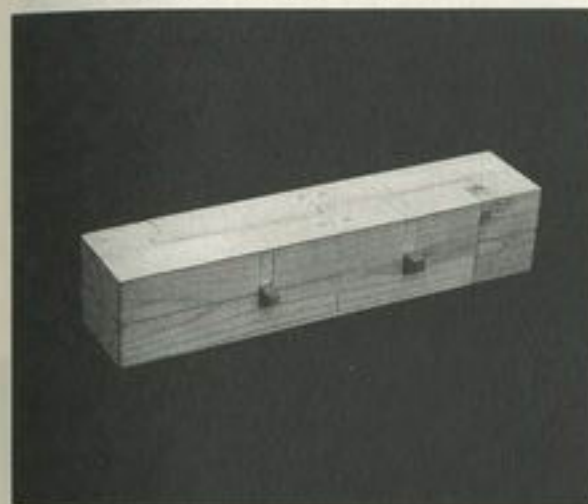

3 Completed splice. The draw pins are inserted.

The tensile test was also carried on an 105mm square section assembly made of black pine. An even bigger strength increase than that of the gooseneck splice was obtained. The joint failed at 4000kg by shearing through one of the adhesion planes.

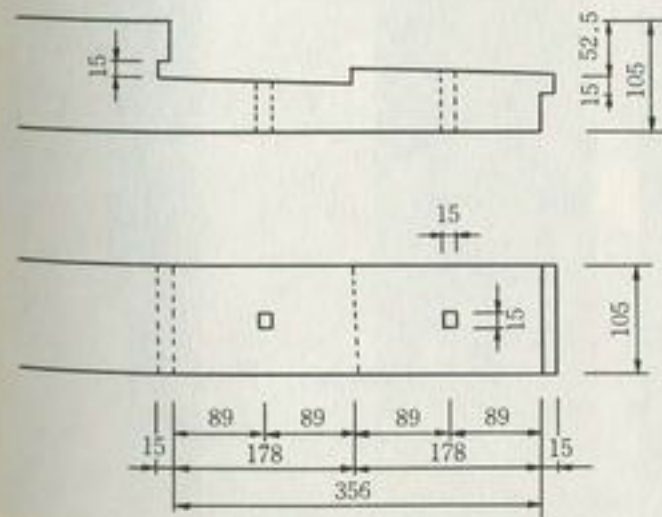

Test sample dimensions

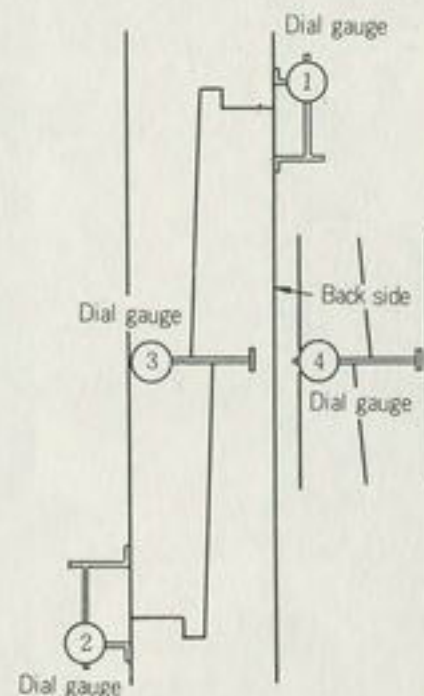

Arrangements of dial gauges

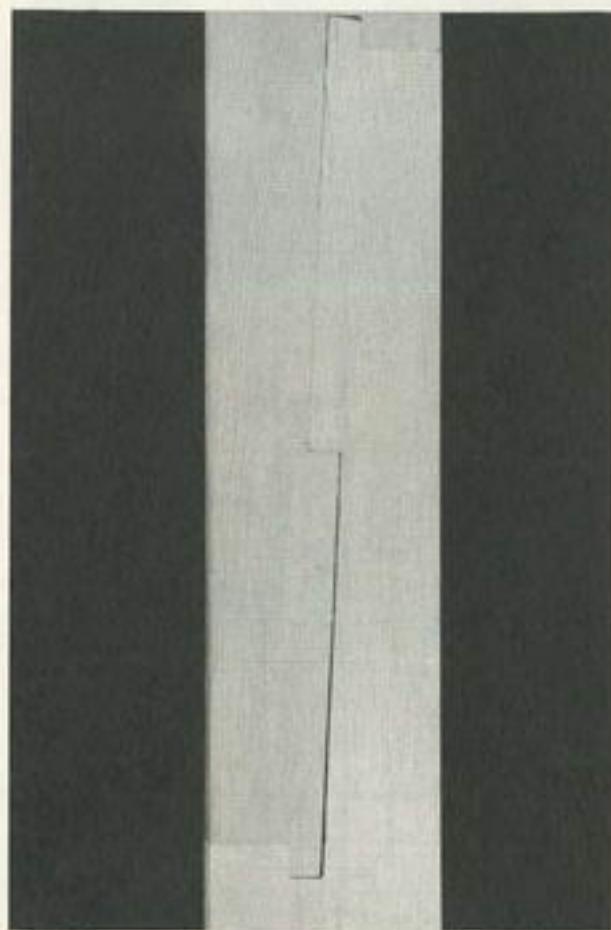
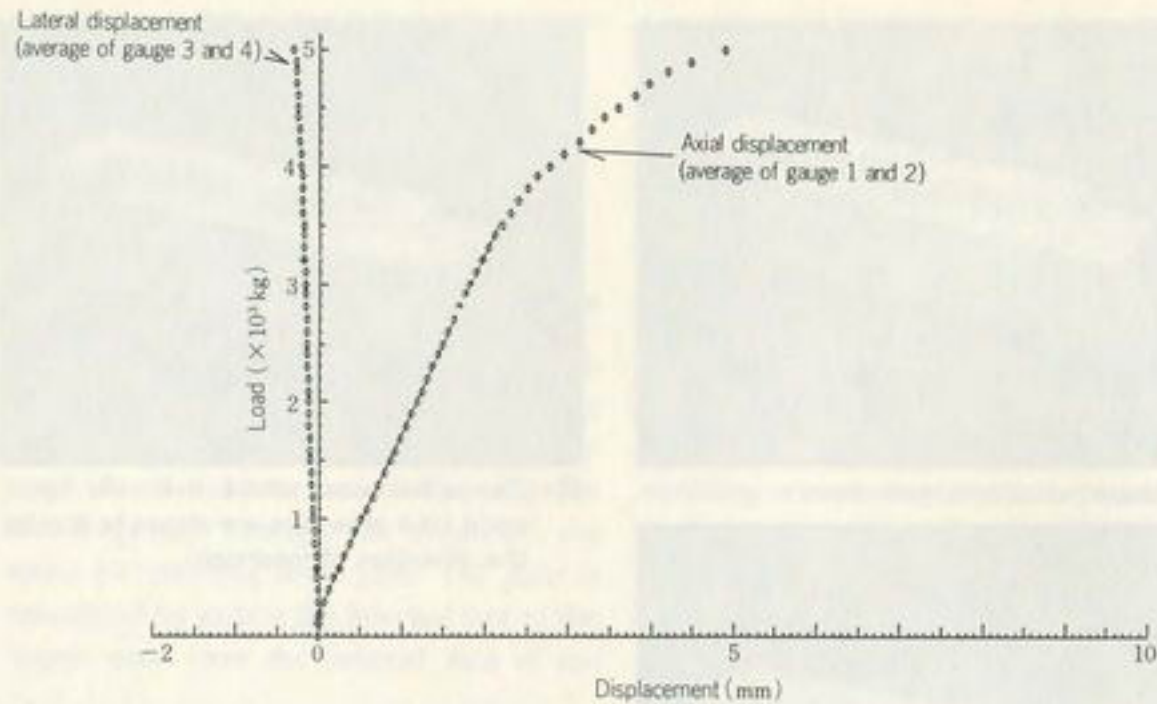

Before failure

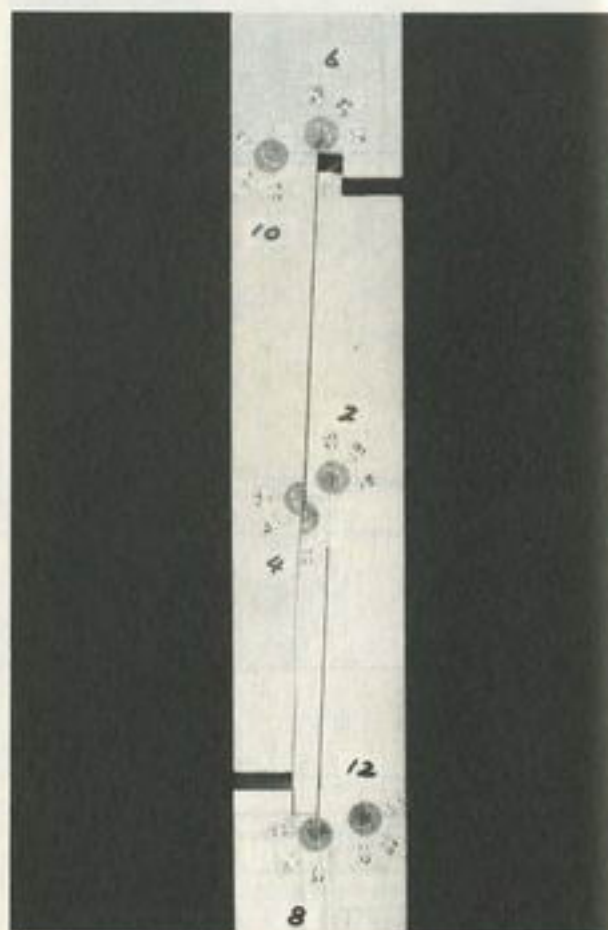

After failure

● SPLICE 04 ●

Mortised rabbeted oblique splice

(Kanawa tsugi)

Both ends of the splice are identical; only the upper wood is displayed in the diagram. This joint is also assembled by sliding over each other the internal faces of the upper wood and lower wood, keeping the surfaces of the middle drops (surfaces "d") in close contact.

To complete this splice, the upper wood is shifted away from the lower wood along the longitudinal axis. Finally a single draw pin is inserted between the middle drops, interlocking the front and back surfaces of the joint (surfaces "a"). This splice is similar to the preceding one. In this case,

the principal difference consists of having to shift away from each other the upper and lower woods to complete the splice. The tensile test produced results identical to splice 03.

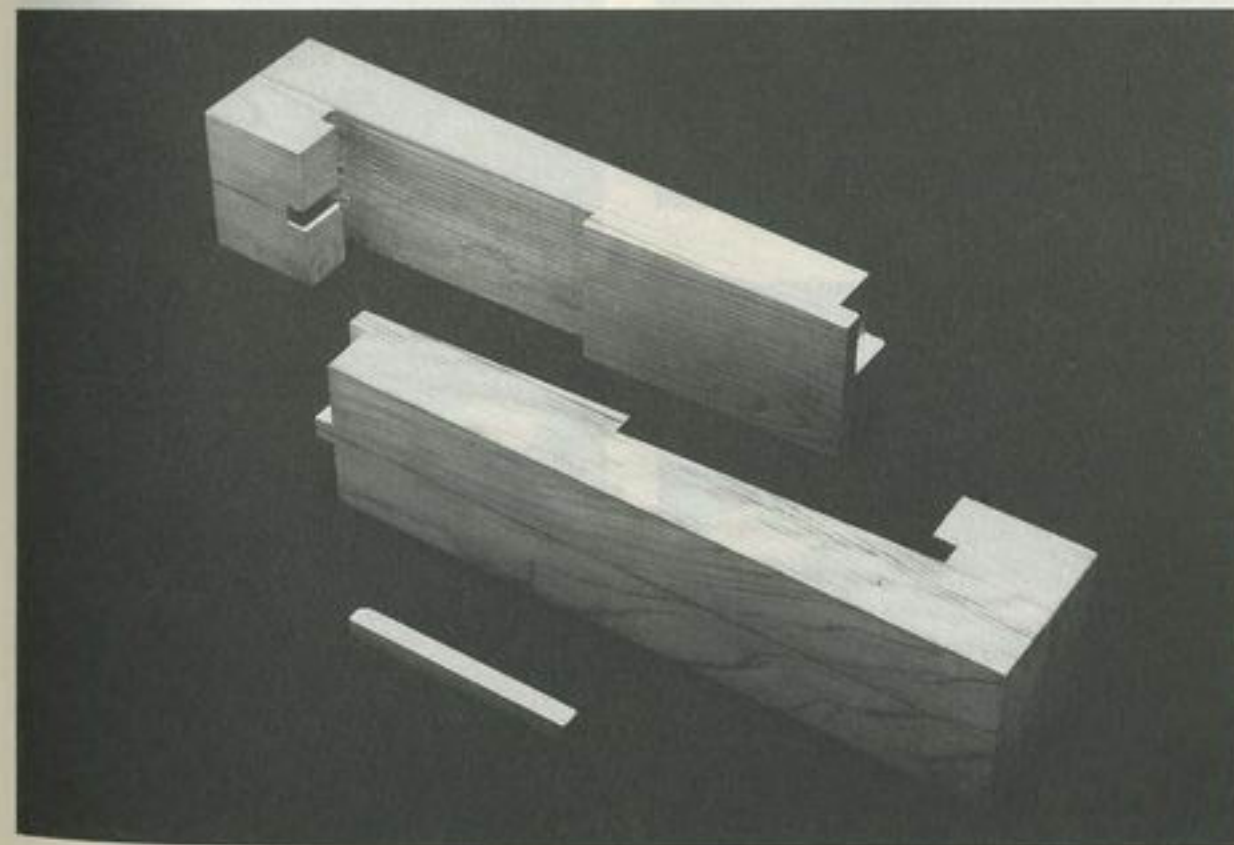
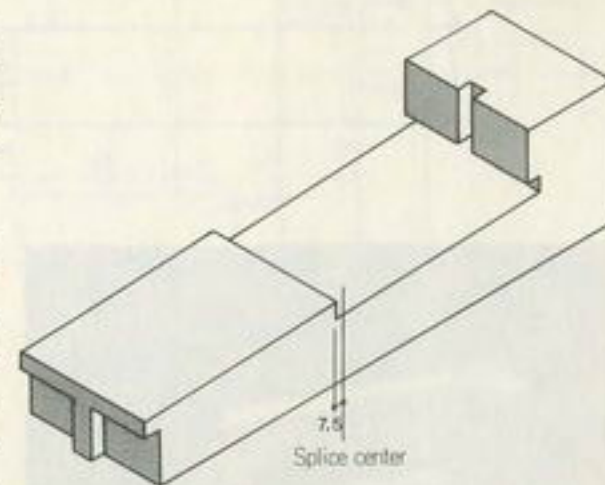

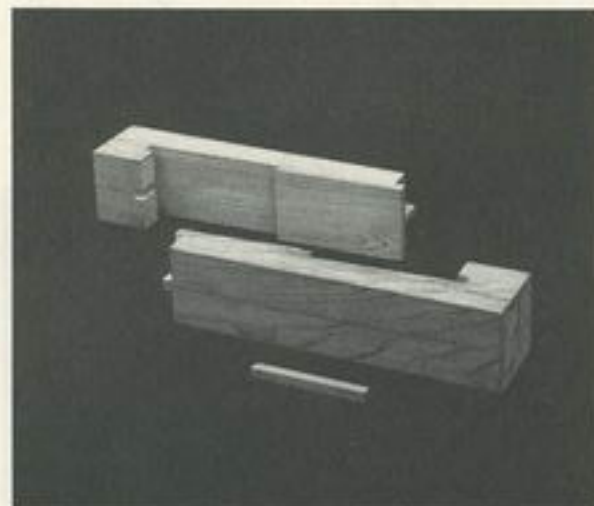
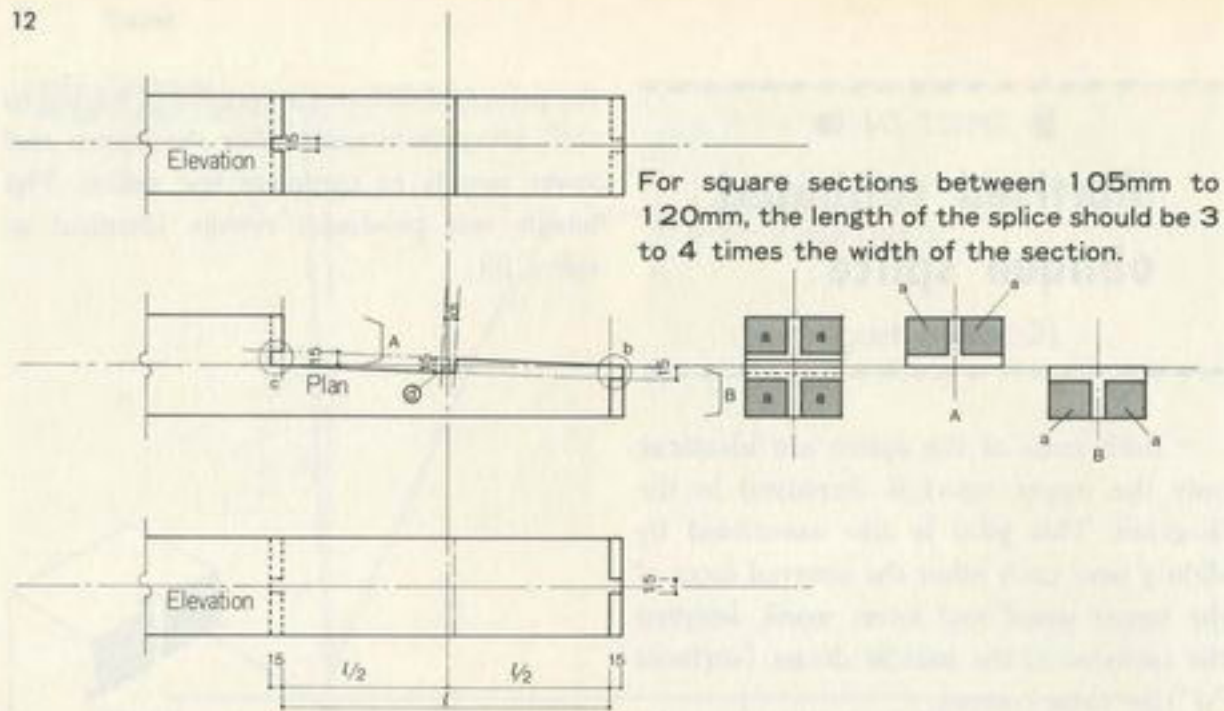

1 Upper wood and lower wood



2 The surfaces of the middle drops (surfaces "d") touch

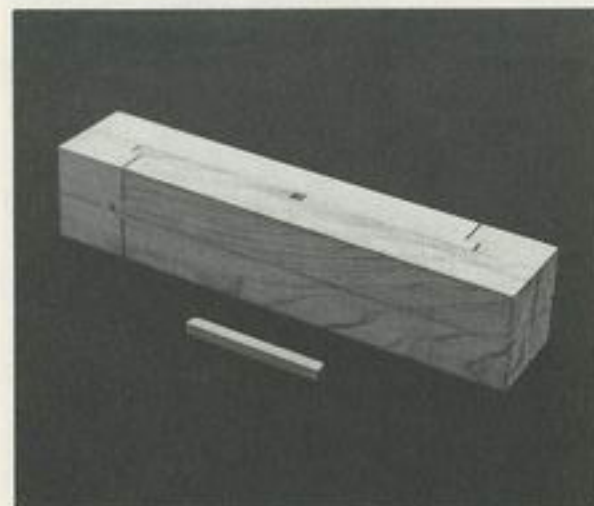

3 A shift in axial direction opens a gap between the middle drops of the upper and lower woods.

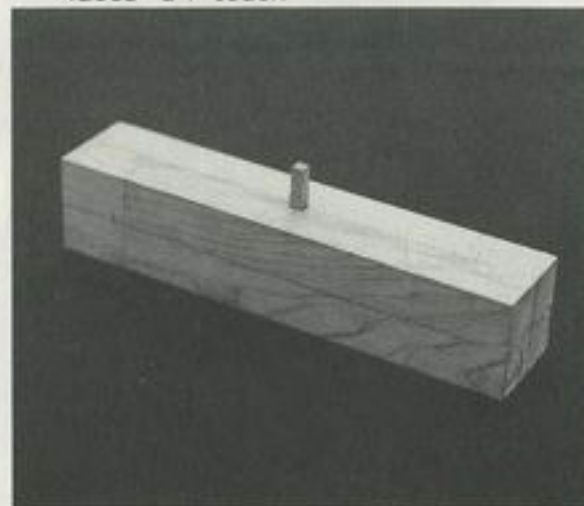

4 The splice is completed by inserting the draw pin.

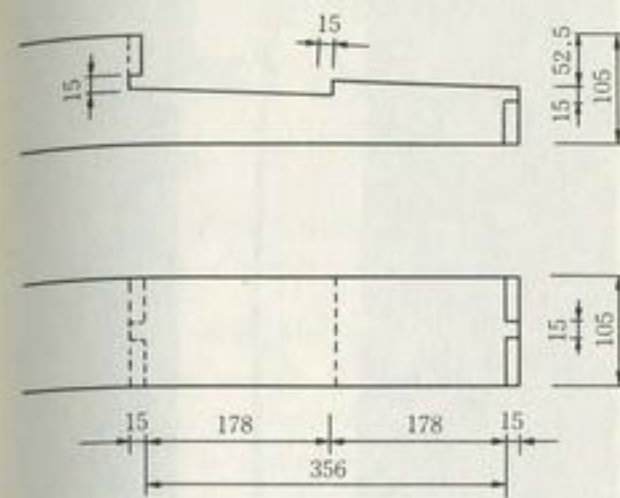

Size of the Dimension of the test sample

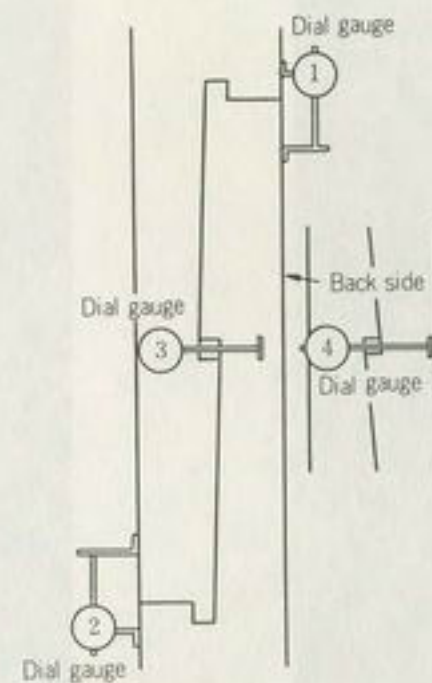

Arrangement of dial gauges

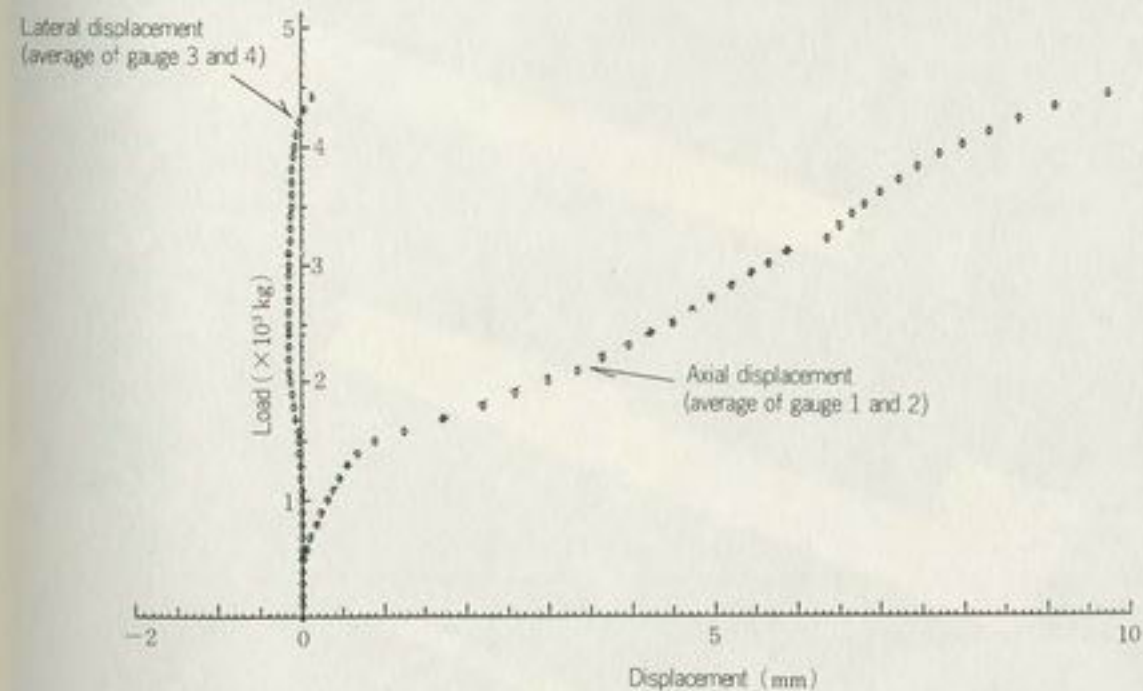

Load displacement curve

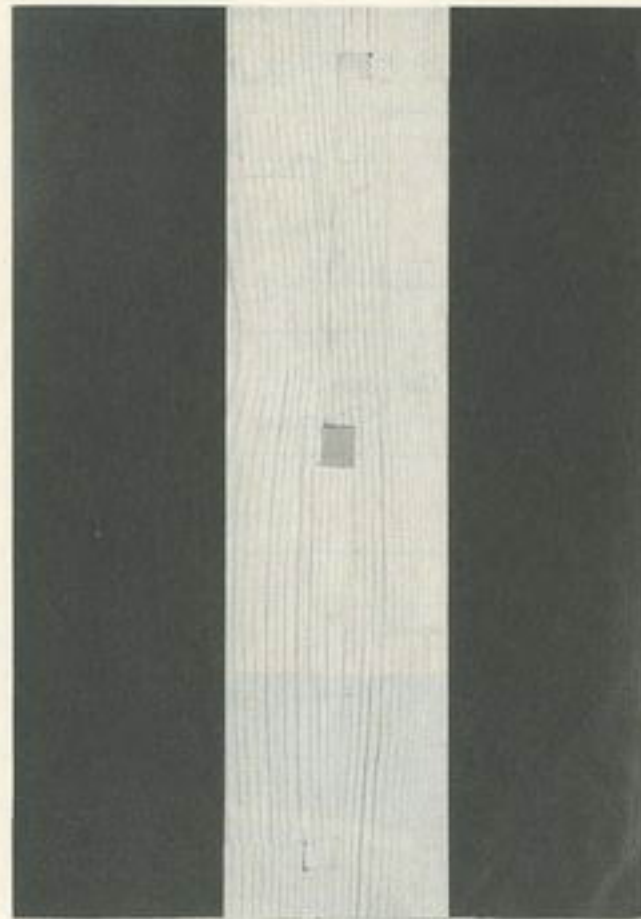

Before failure

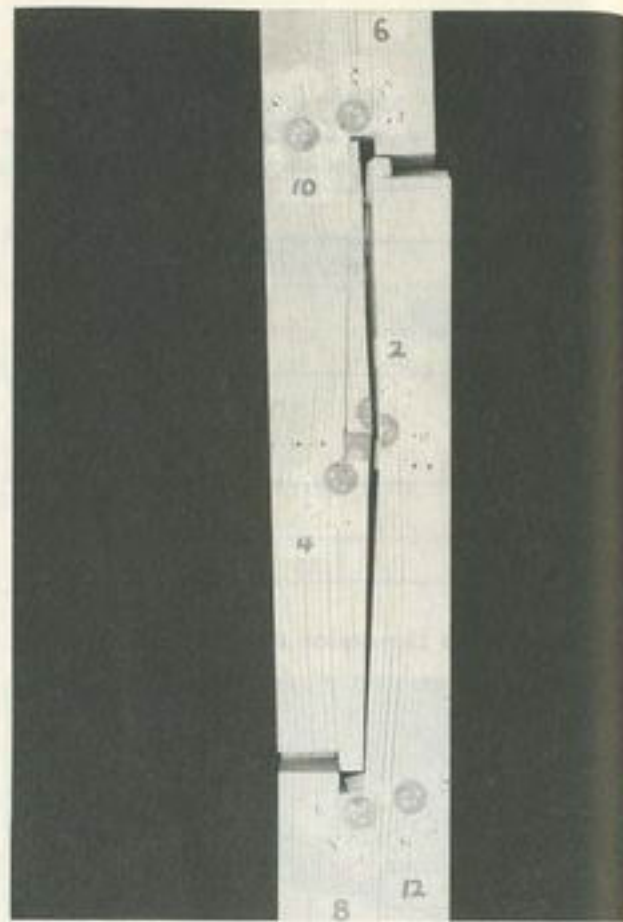

After failure

● SPLICE 05 ●

Blind stubbed, housed rabbeted oblique scarf splice

(Shiribasami tsugi)

The shape and mechanical properties of this splice are practically identical to splice 04. Aesthetically speaking however, this splice is said to be of a superior design than other rabbeted oblique scarf splices; an elevation view of the splice reveals only a clean straight line.

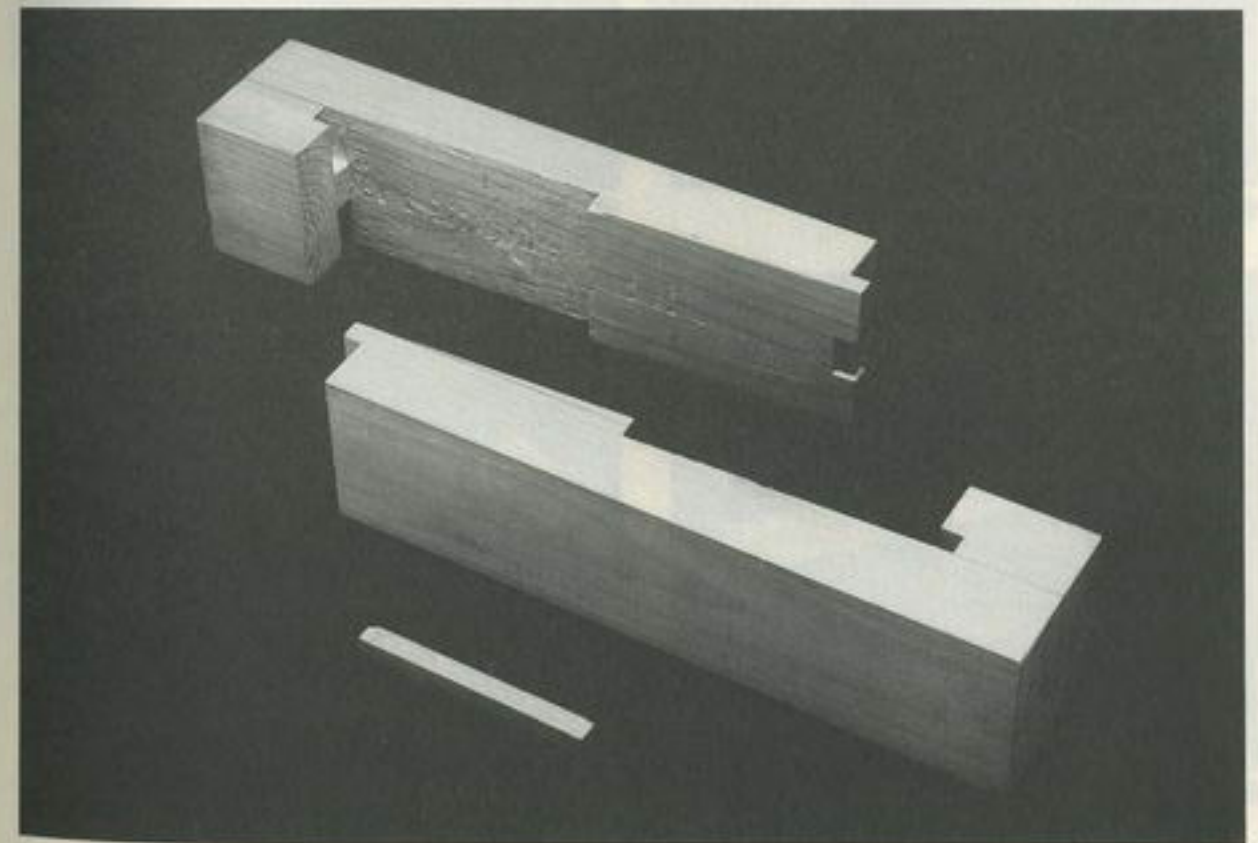
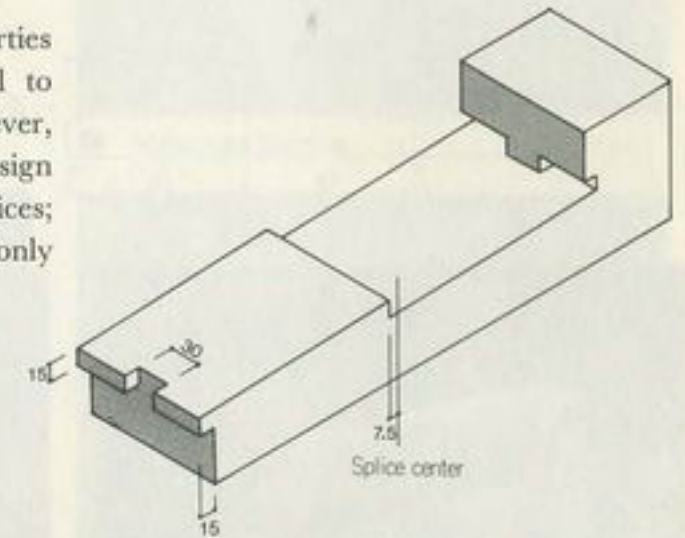

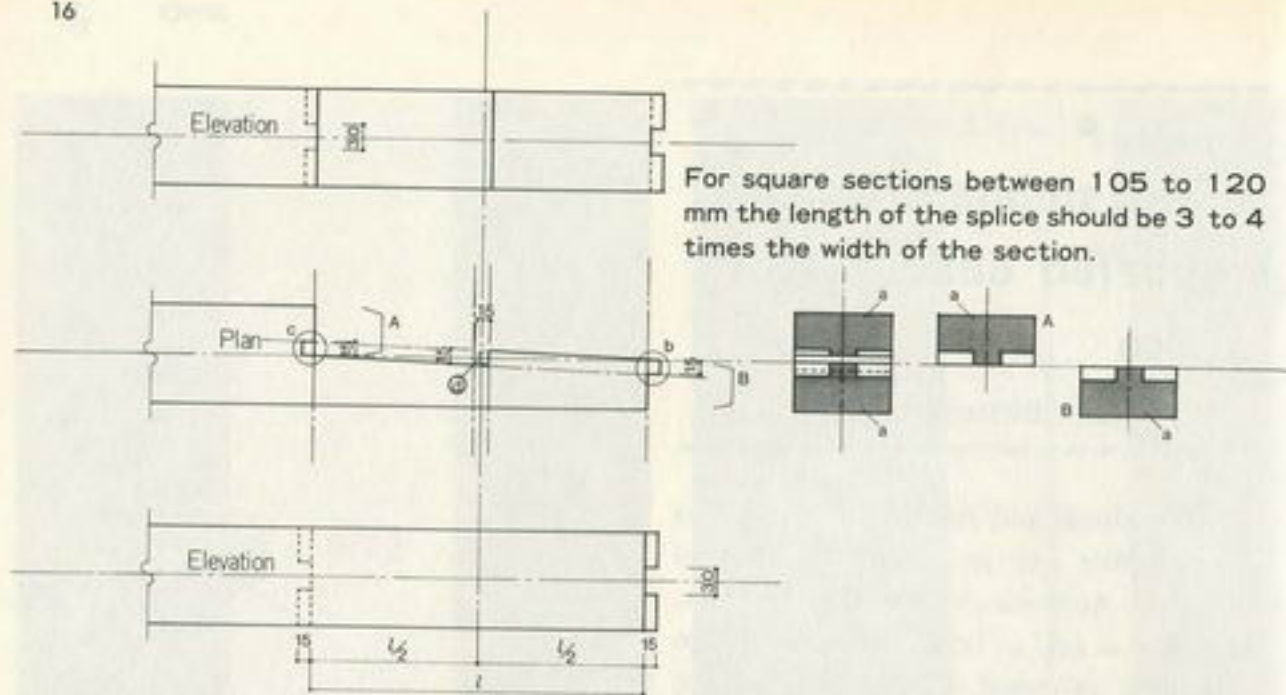

1 Upper wood and lower wood



2 The surfaces of the middle drops (surfaces "d") touch

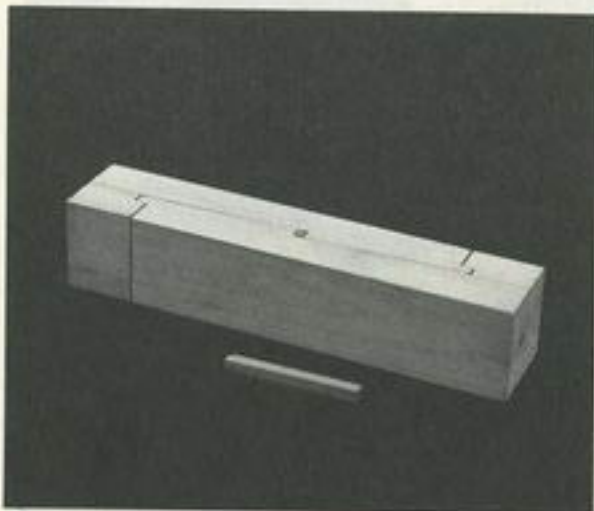

3 A shift in axial direction opens a gap between the middle drops of the upper and lower wood.

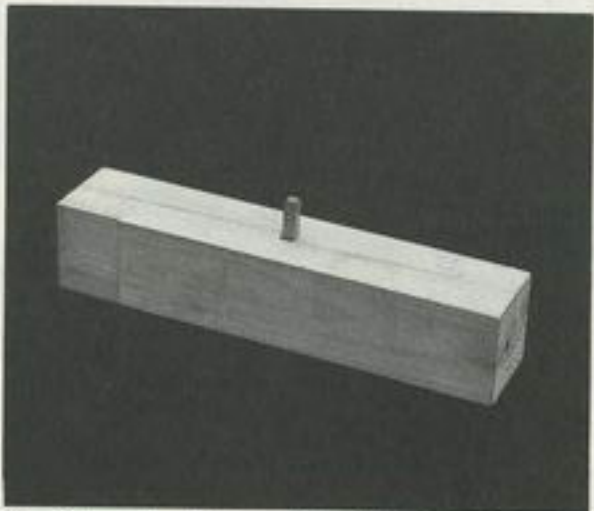

4 The splice is completed by inserting the draw pin.

● SPLICE 06 ●

Tenon and mortise splices

(Mechiire)

(1) Cross-shaped tenon and mortise splice (juji mechiire)

This splice is effective against torsion but cannot resist any tensile forces. It is often combined with splicing plates bolted throughout.

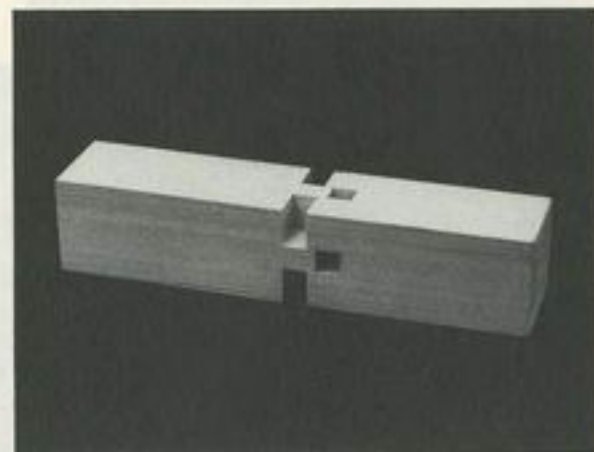

1 Male and female

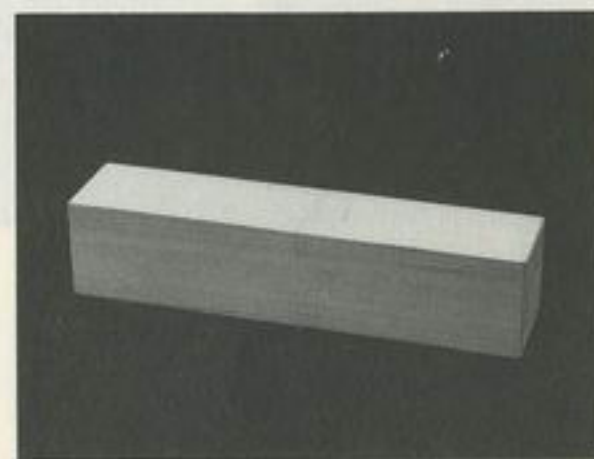
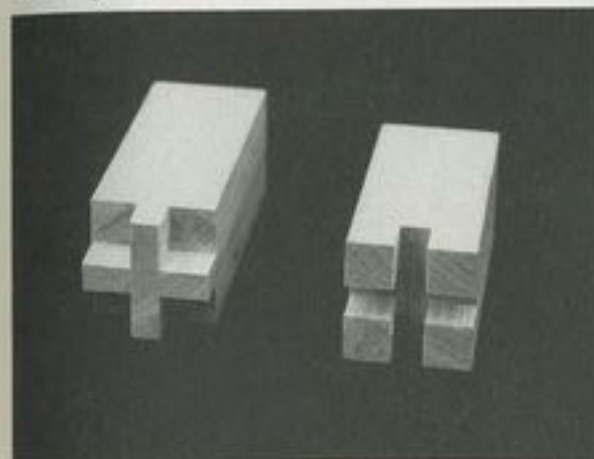

2 Assembled splice

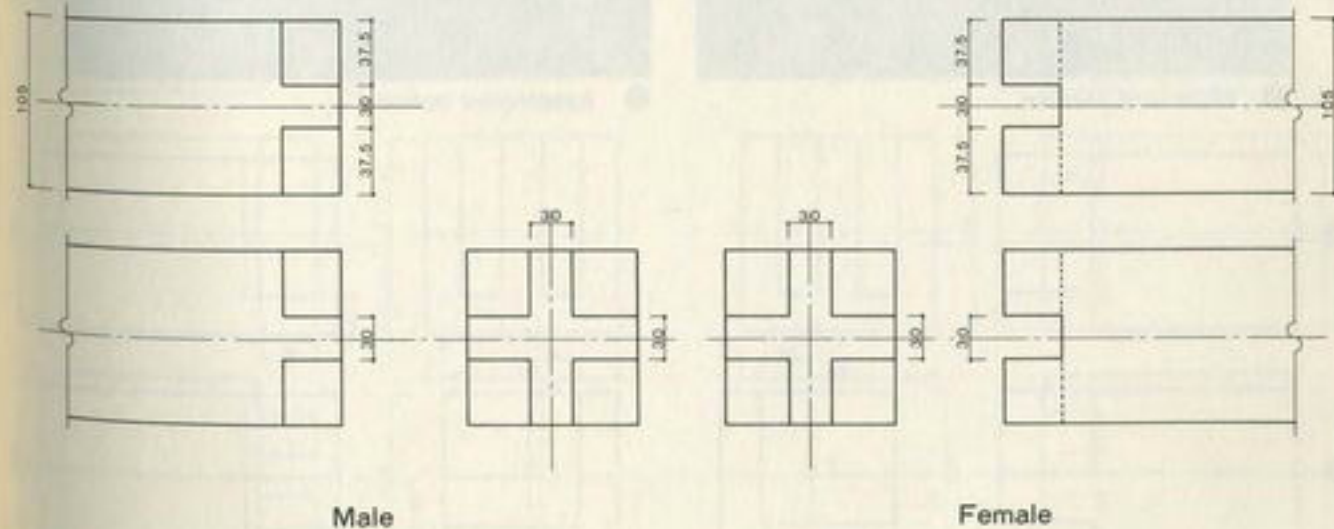

Male

Female

(2) **Right angle tenon and mortise splice**
(kaneori mechiire)

Two faces of this splice reveal a clean straight line when assembled.

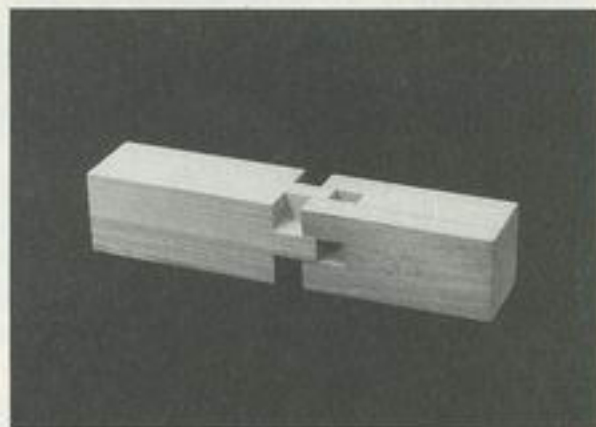
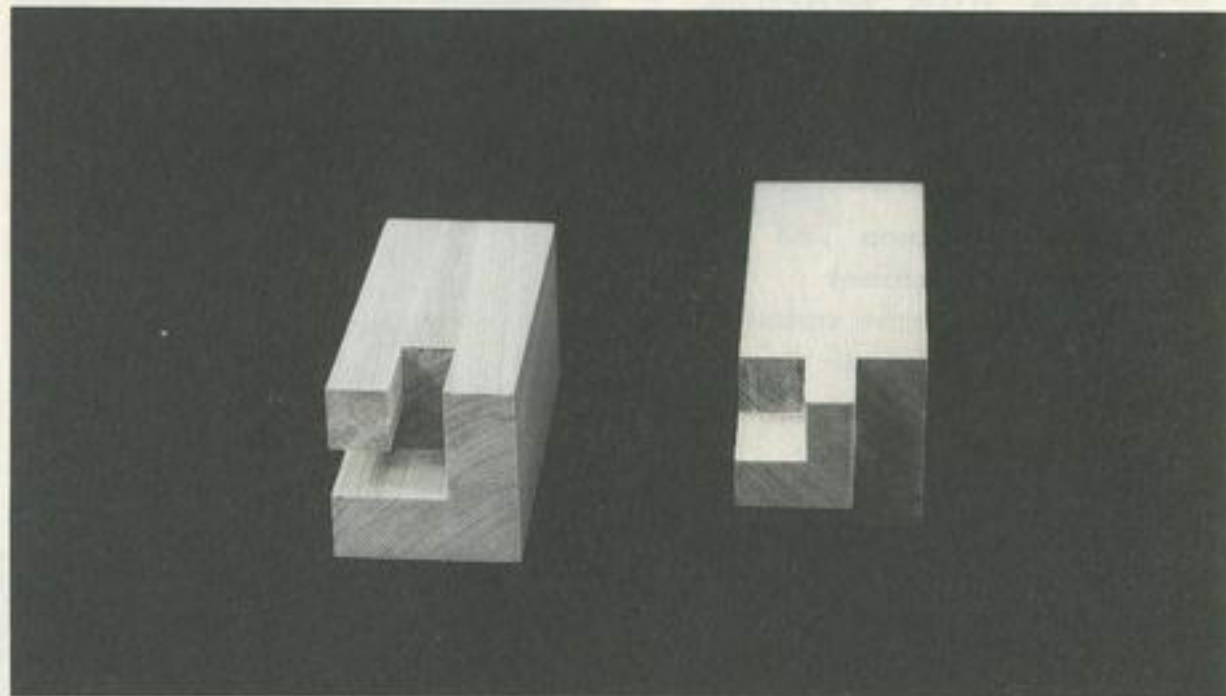

① Male and female

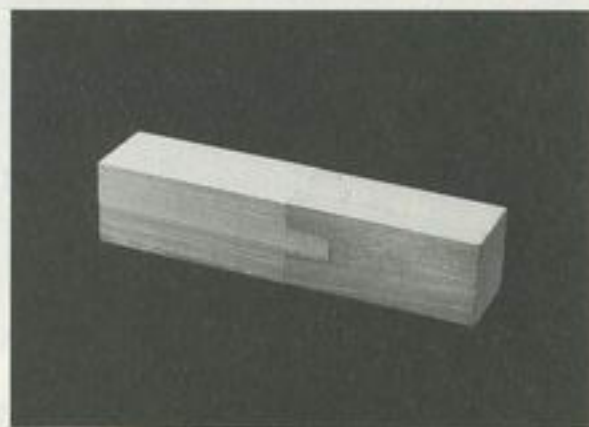

② Assembled splice

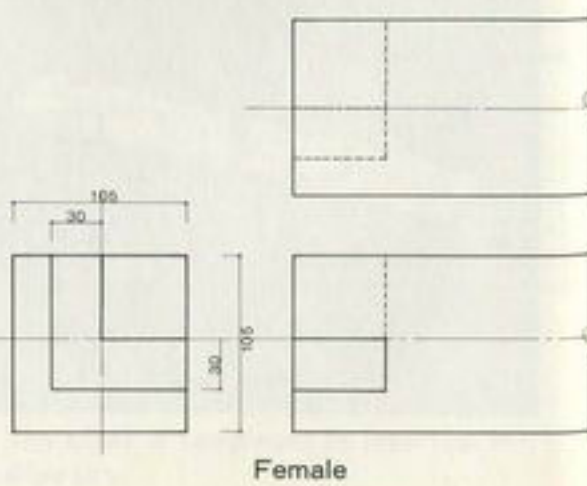
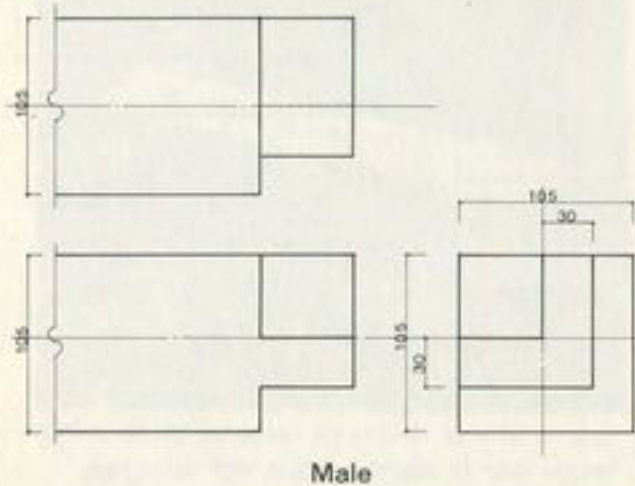

(3) **Housed tenon and mortise splice**
(kakushi mechiire)

Three faces of this splice reveal a clean straight line once assembled. It is a common method for splicing exposed posts.

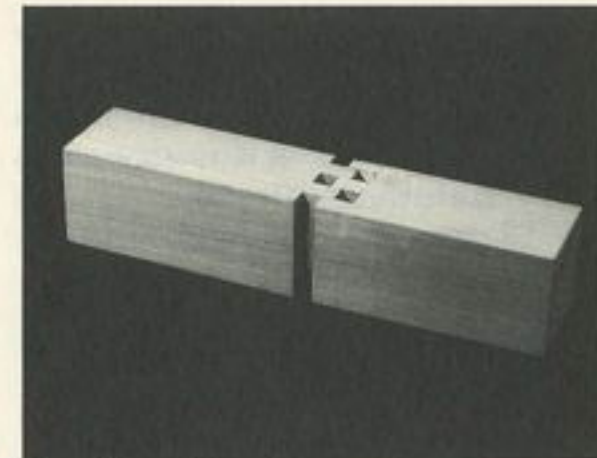

① Male and female

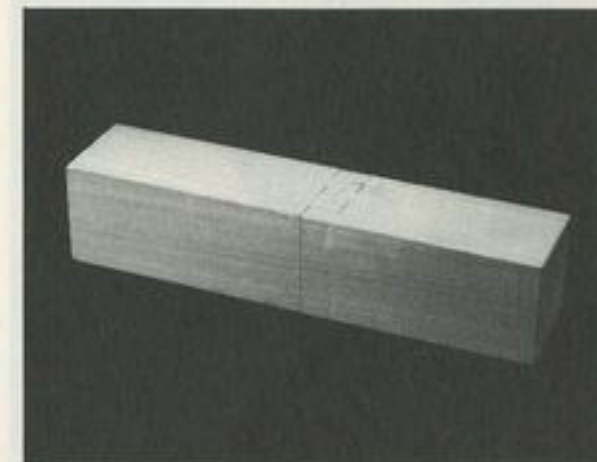
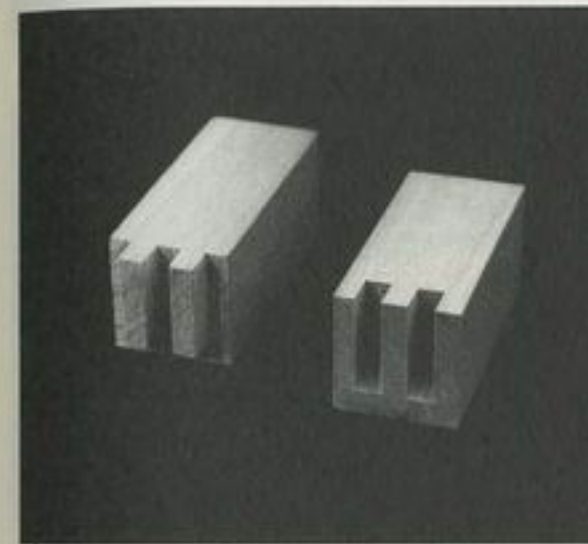

② Assembled splice

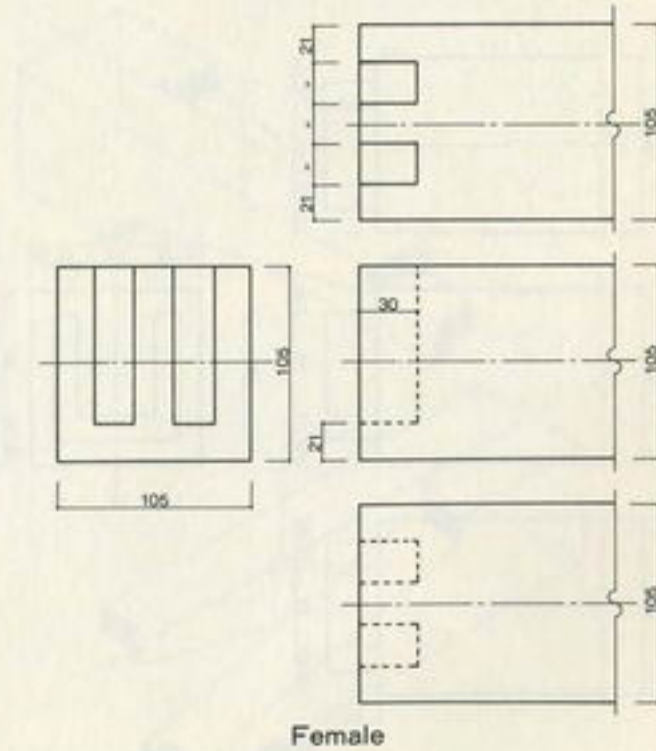
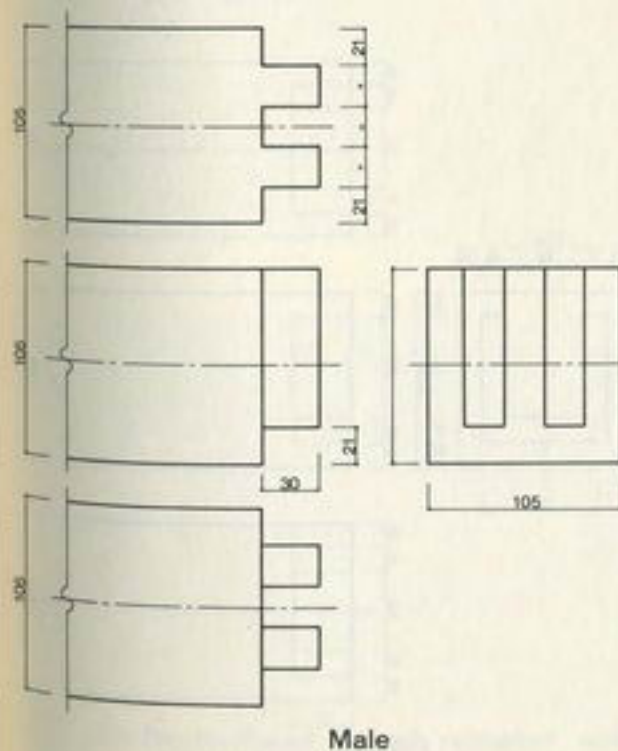

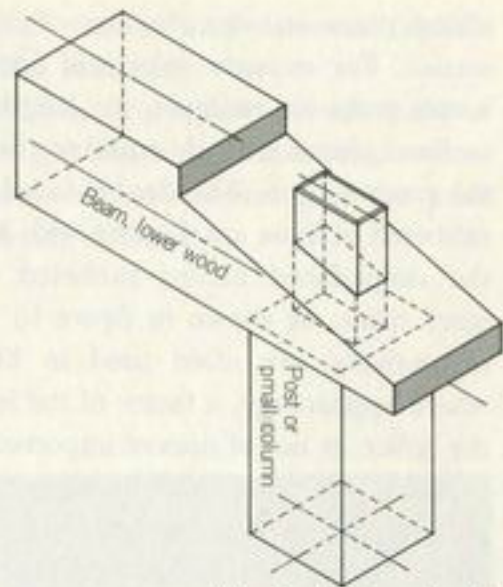

(c) Single faced rabbeted oblique scarf splice

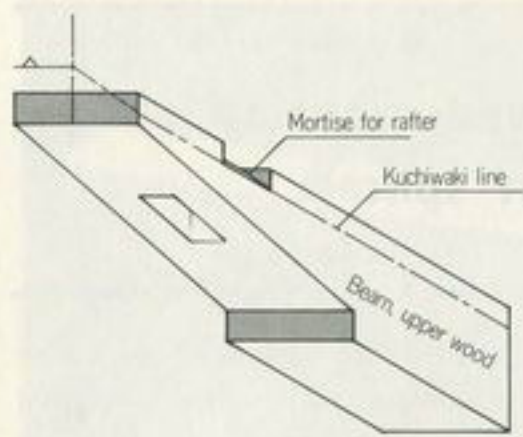

(1) Triple-faced halved rabbeted oblique scarf splice with key

The key has no structural function. It is designed so that the splice cannot be easily pulled apart. As mentioned earlier, the appearance of these joints is a direct function of the length of the splice. However, the longer splices are also weaker. Consequently, the inclined faces of the joint are made to be a maximum of two times the size of the cross section.

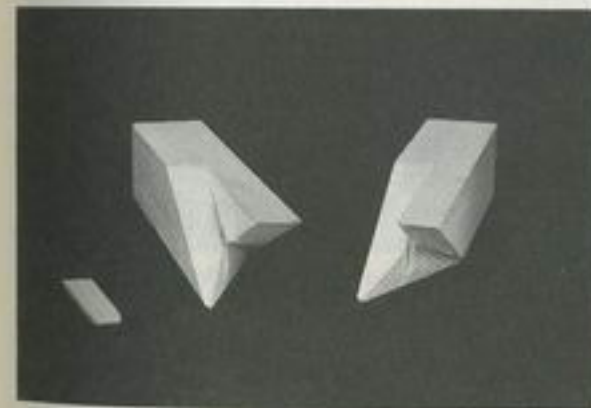
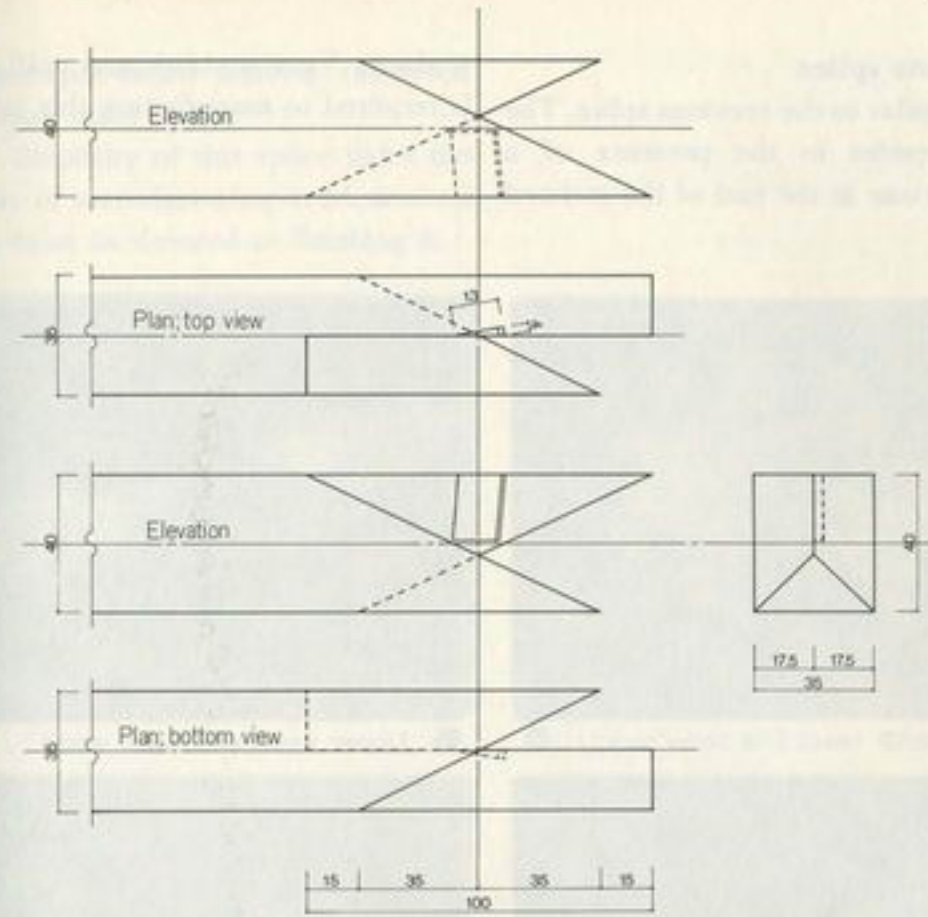
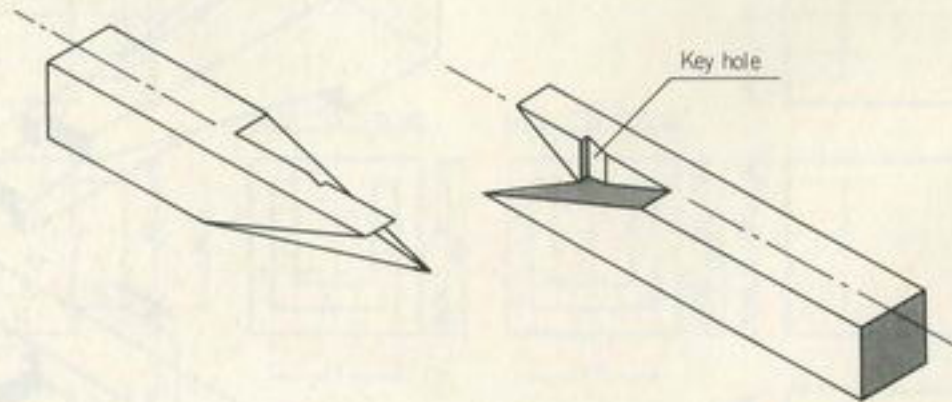

1 Upper wood and lower wood

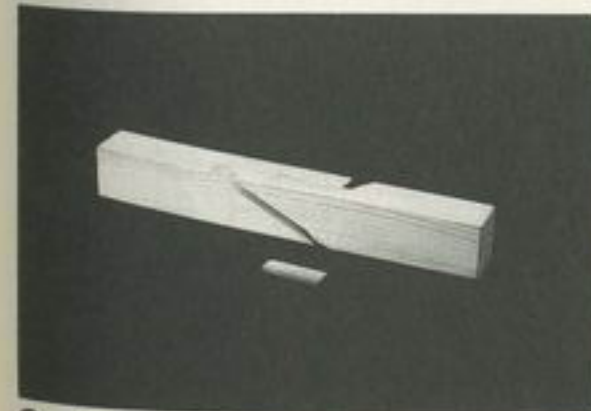
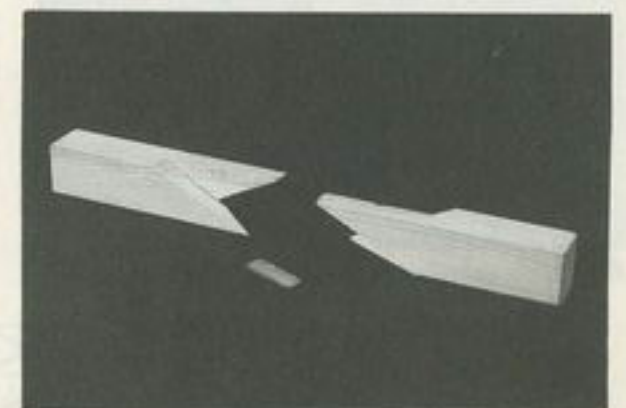

2 Assembling the splice



3 The splice is completed by locking it with a key.

(2) Miyajima splice

Very similar to the previous splice. The difference resides in the presence of a triple-faced cone at the end of the inclined

surfaces. Very sophisticated craftsmanship is required to manufacture this joint.

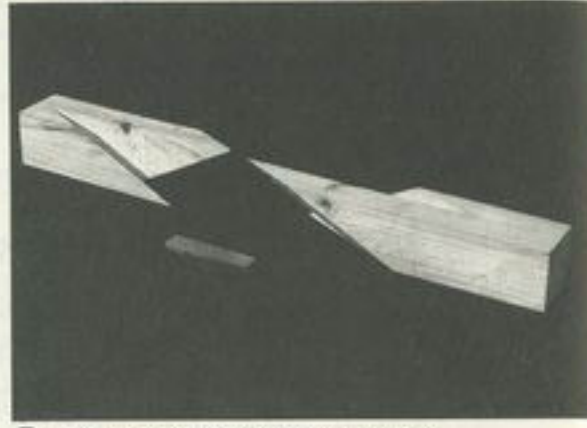
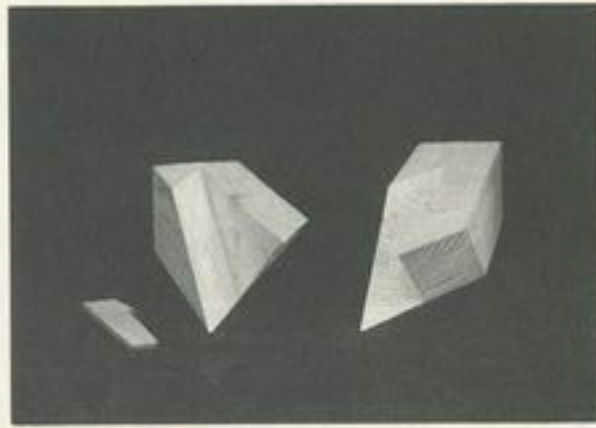

① Upper wood and lower wood

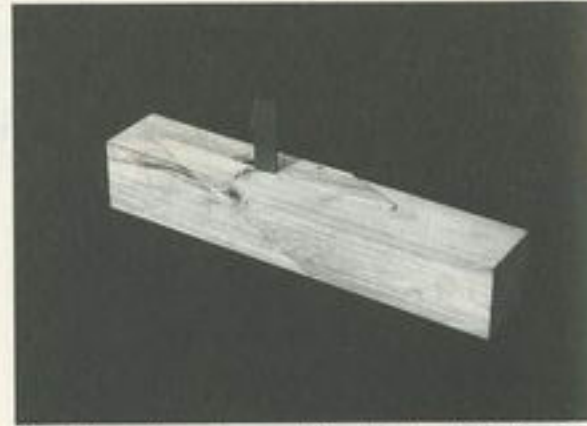
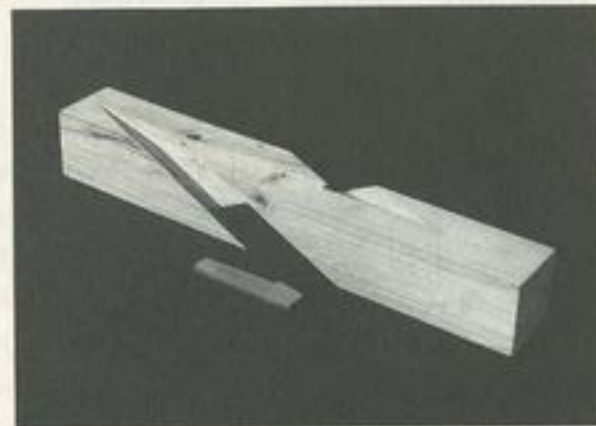

② Assembling the splice

③ The splice is completed by locking it with a key.

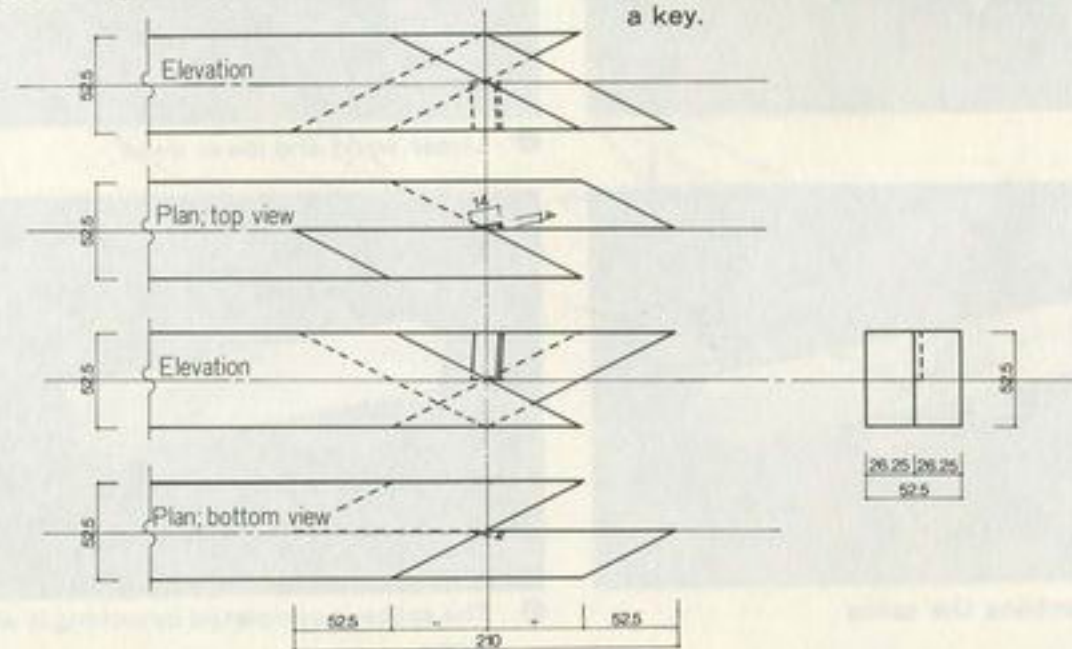

(3) Quadruple-faced halved rabbeted oblique scarf splice

The simplicity of this splice hides the complexity of manufacturing it. Meticulous attention must be devoted to finishing it.

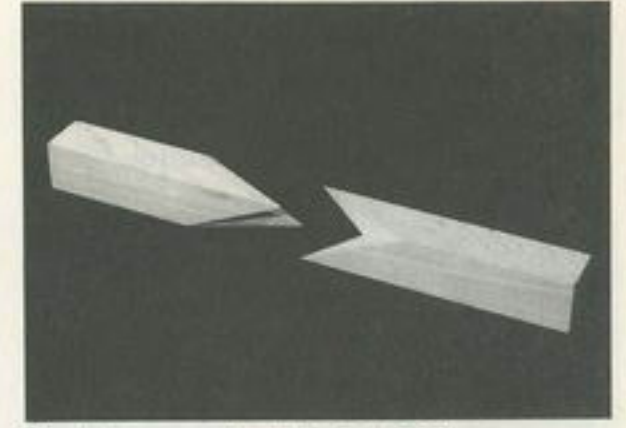
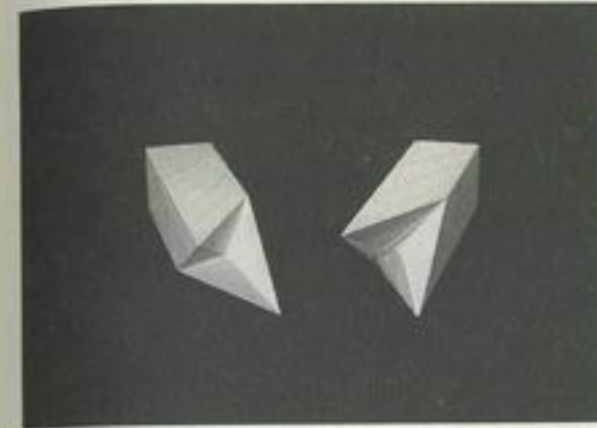

① Upper wood and lower wood

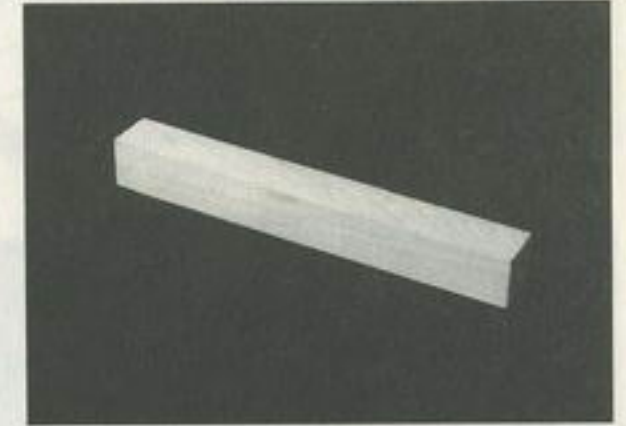
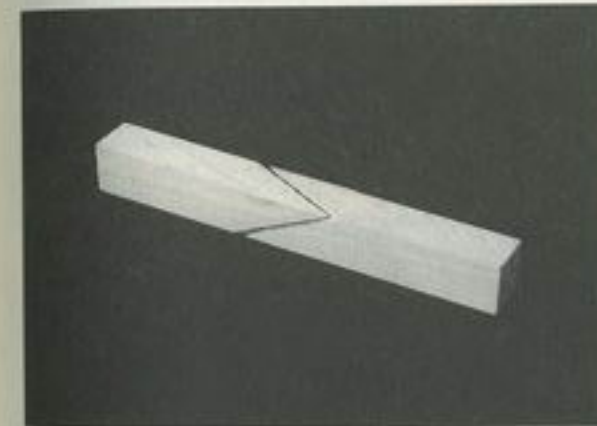

② Assembling the splice

③ The splice is completed by locking it with a key.

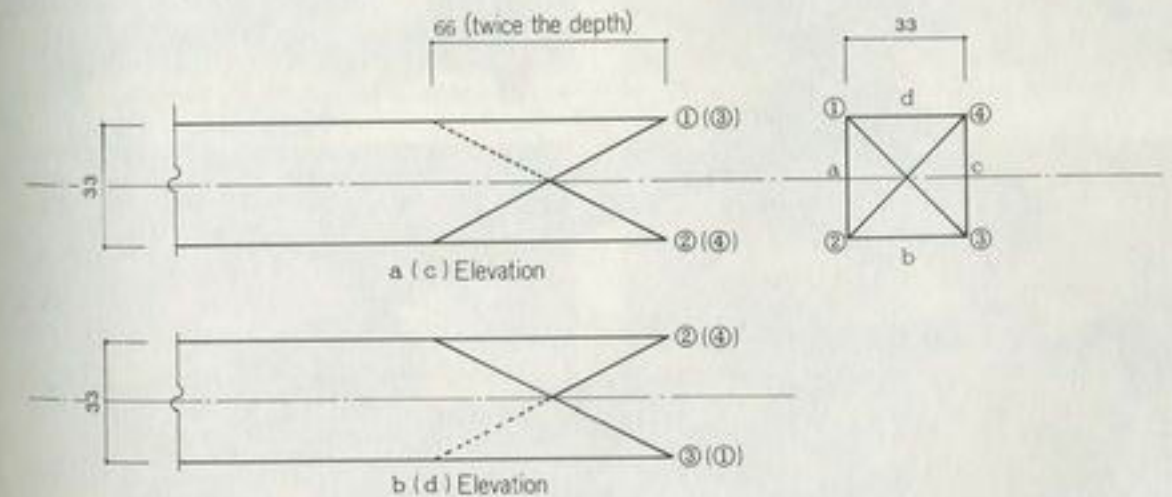

(3) **Blind pin (hako sen)**

This splice also follows the model of the rabbeted oblique scarf splice. The form of splice 04 is carved on two perpendicular faces.

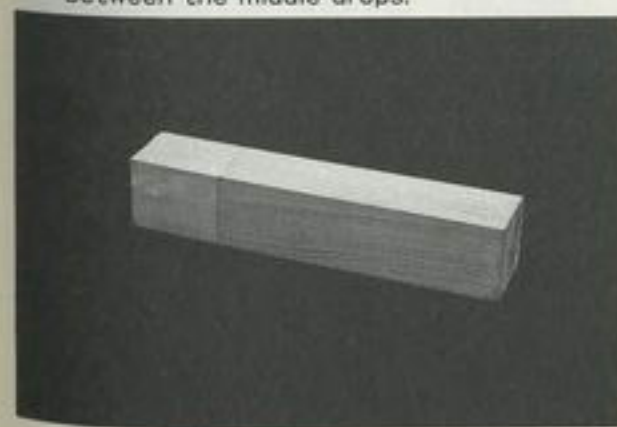
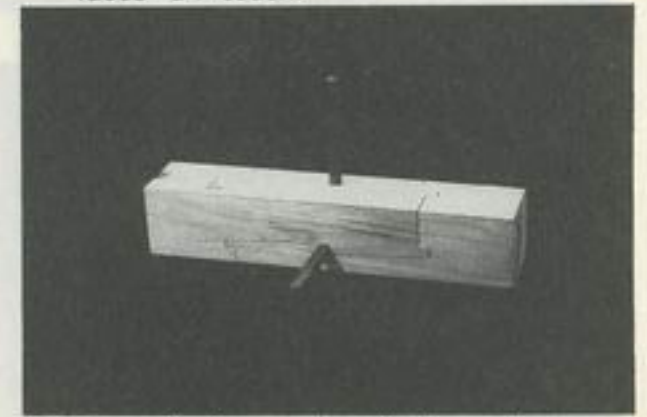
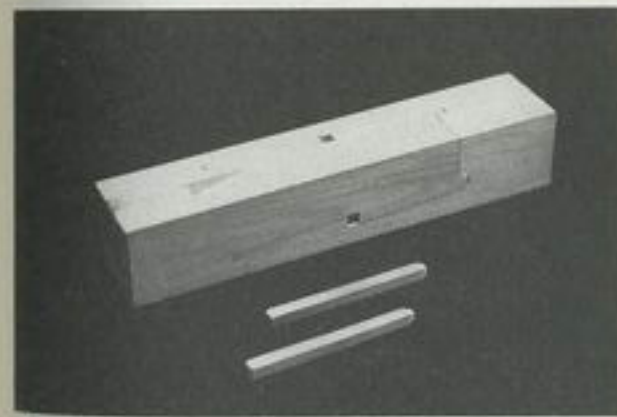
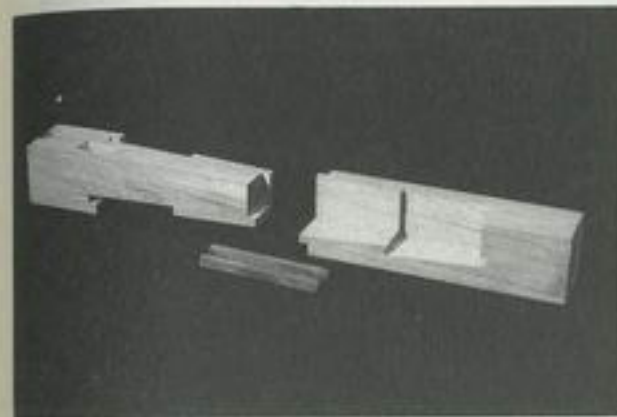
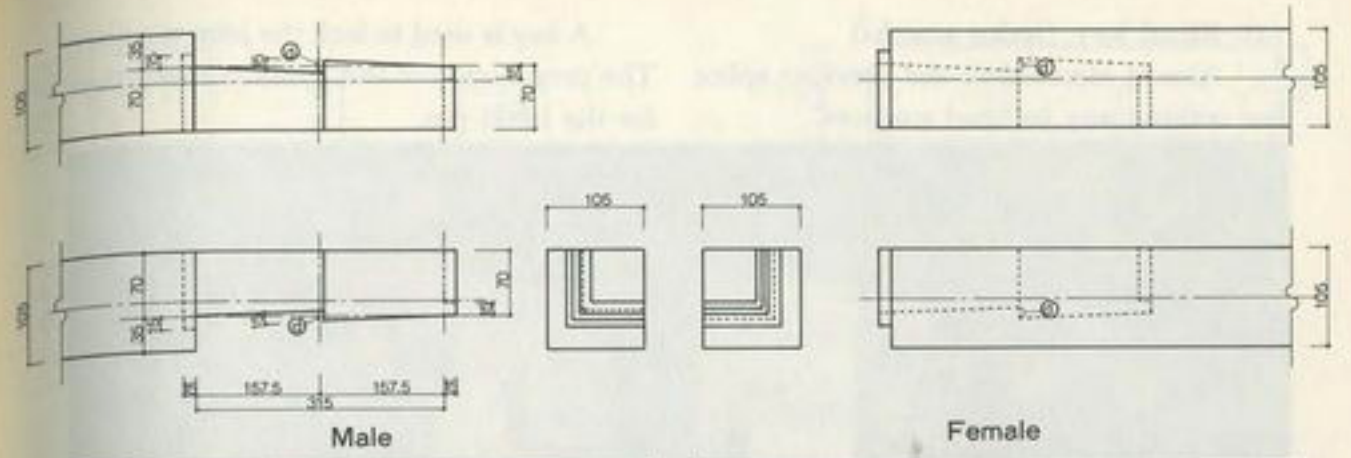
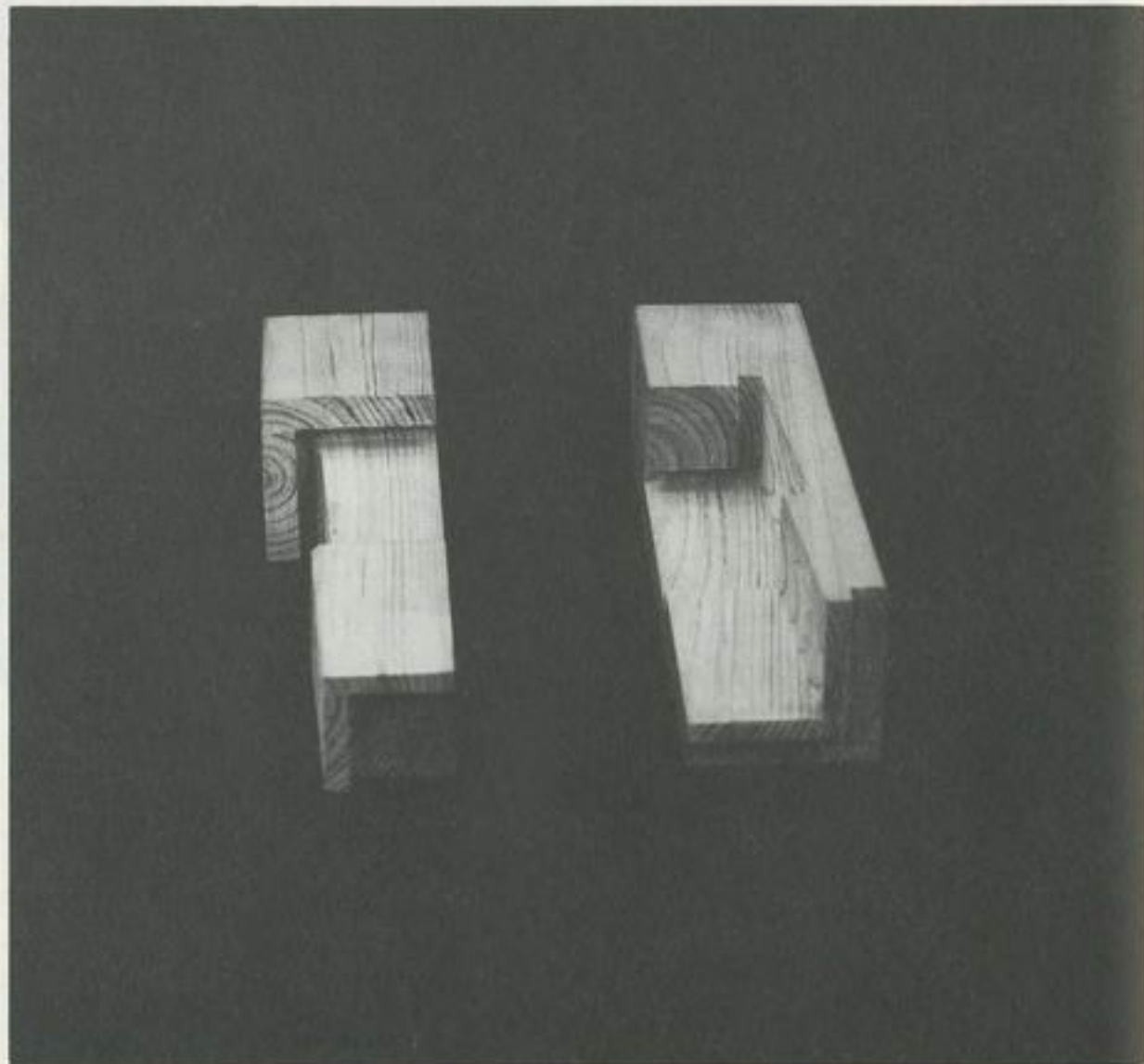
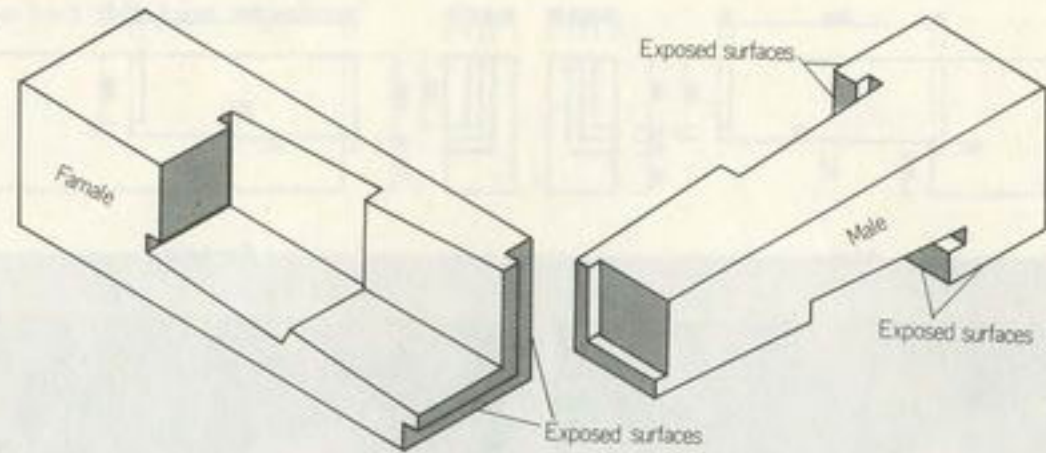

(4) **Blind key (hako shachi)**

Almost identical to the previous splice but without any inclined surfaces.

A key is used to lock the joint together. The preparation of this splice is easier than for the blind pin.

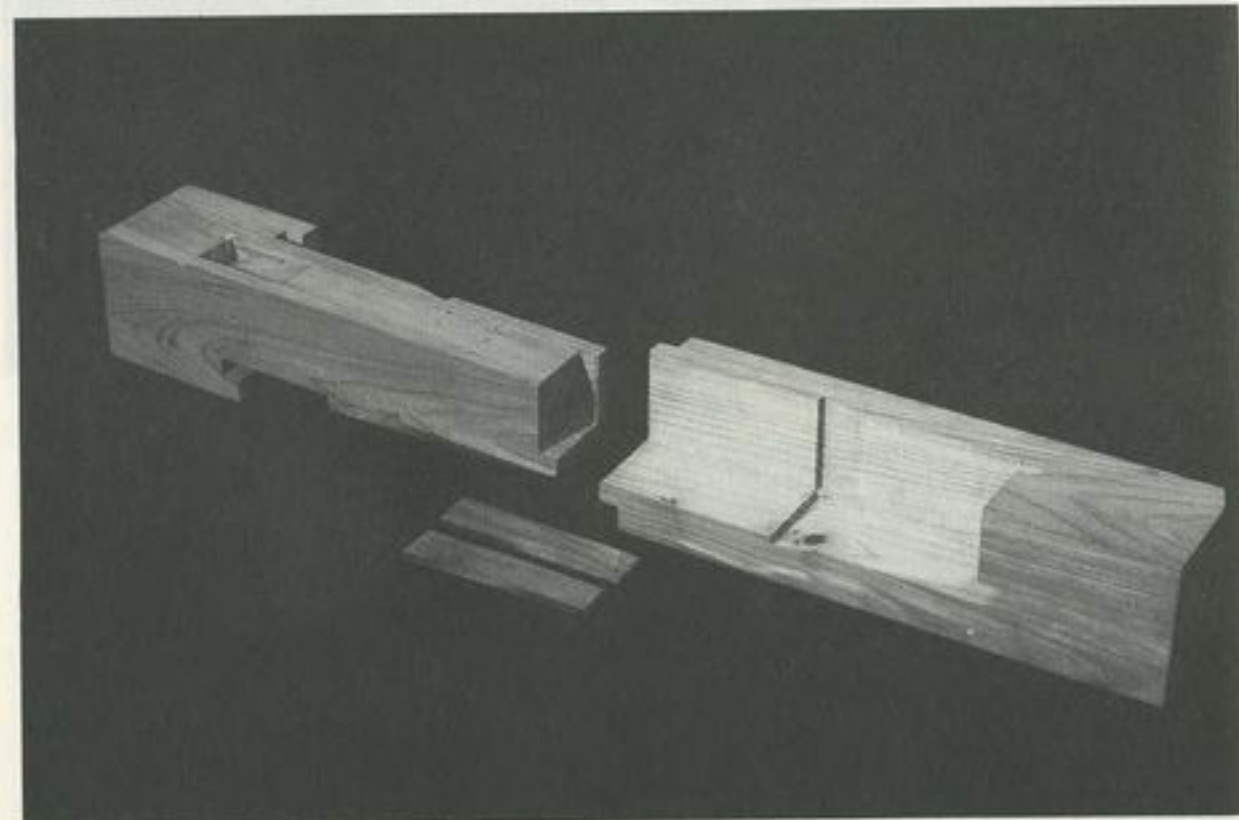
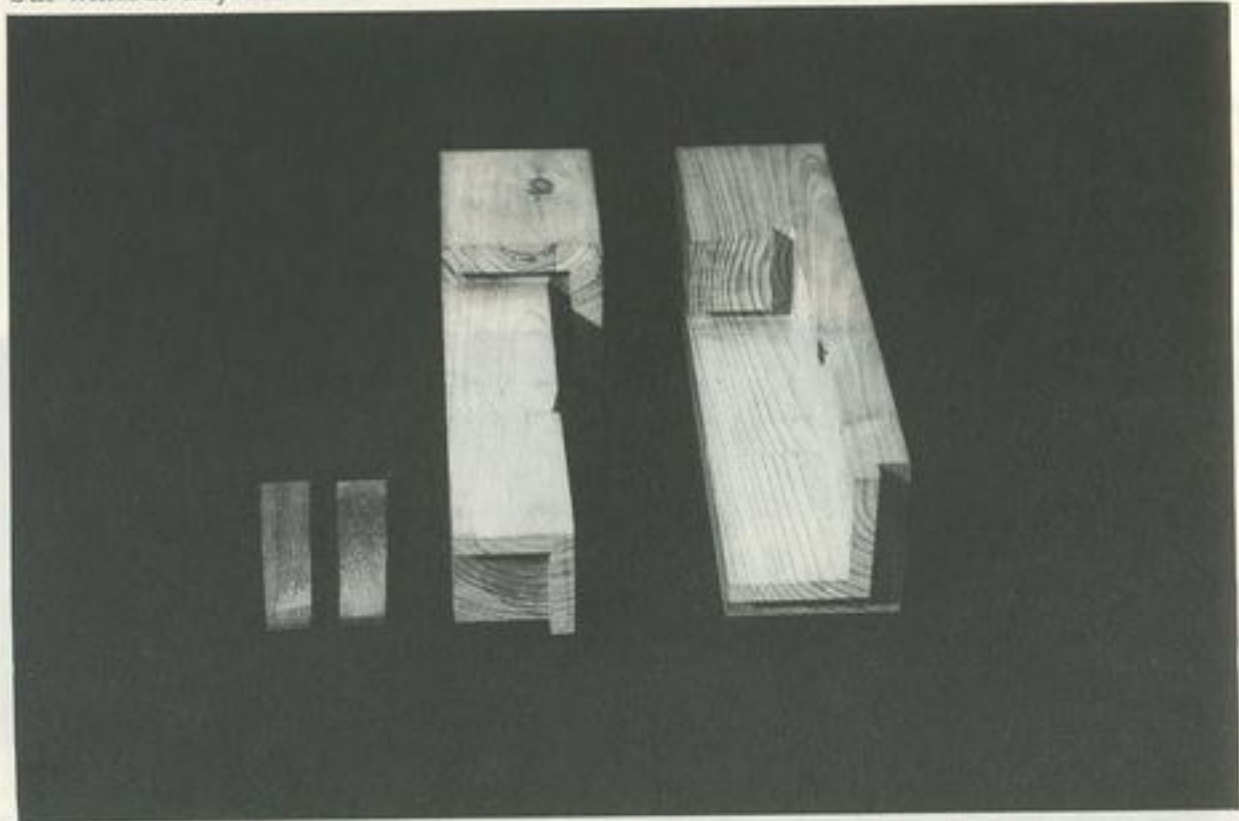

① Male and female

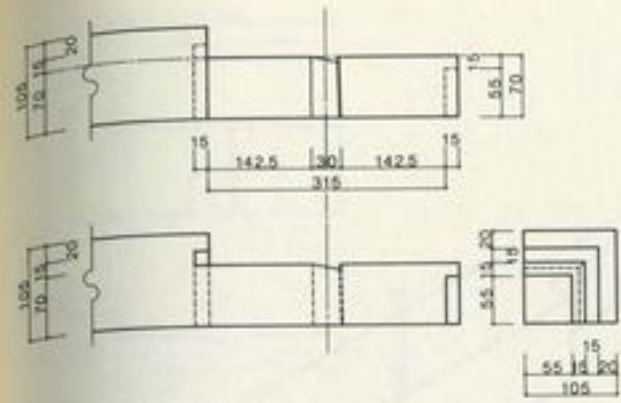

Male

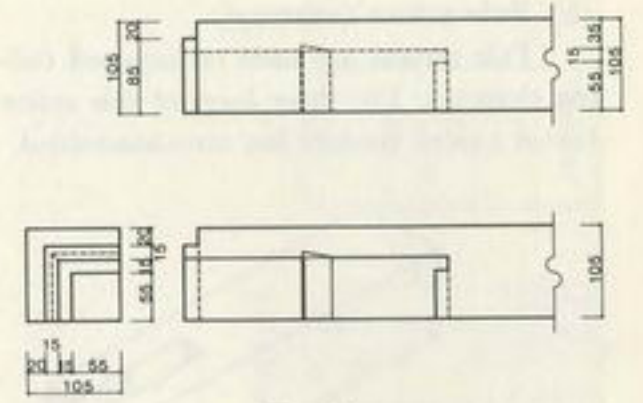

Female

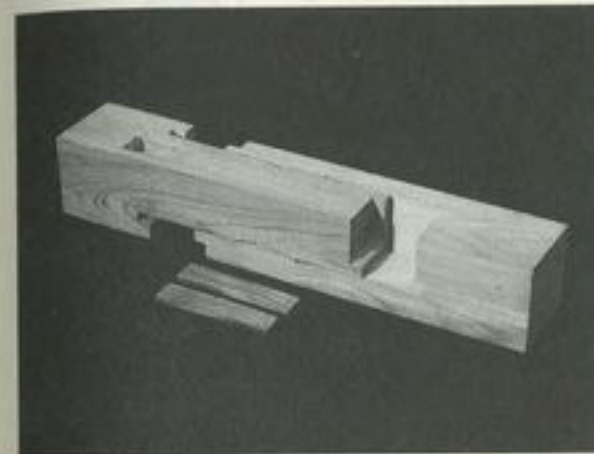

② The male slides into the female.



③ Same



④ The splice is completed by inserting two keys.

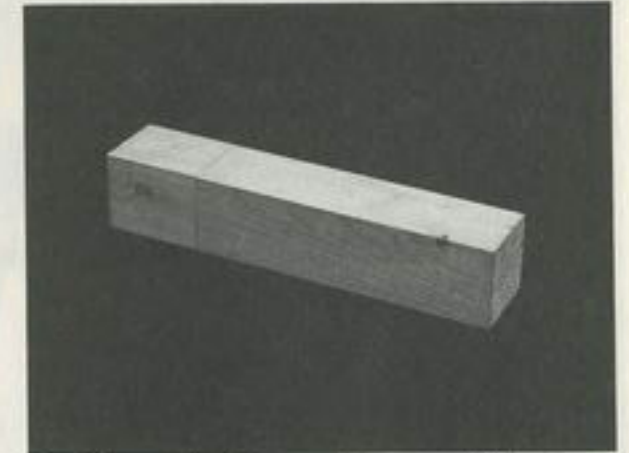

⑤ Exposed surfaces after completion

(5) Pole tenon (saotsugi)

Pole tenons are used on exposed ceiling elements. The three faces of this splice reveal a clean straight line once assembled.

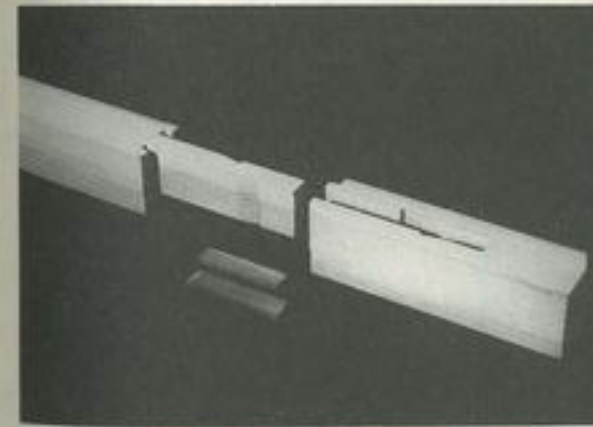
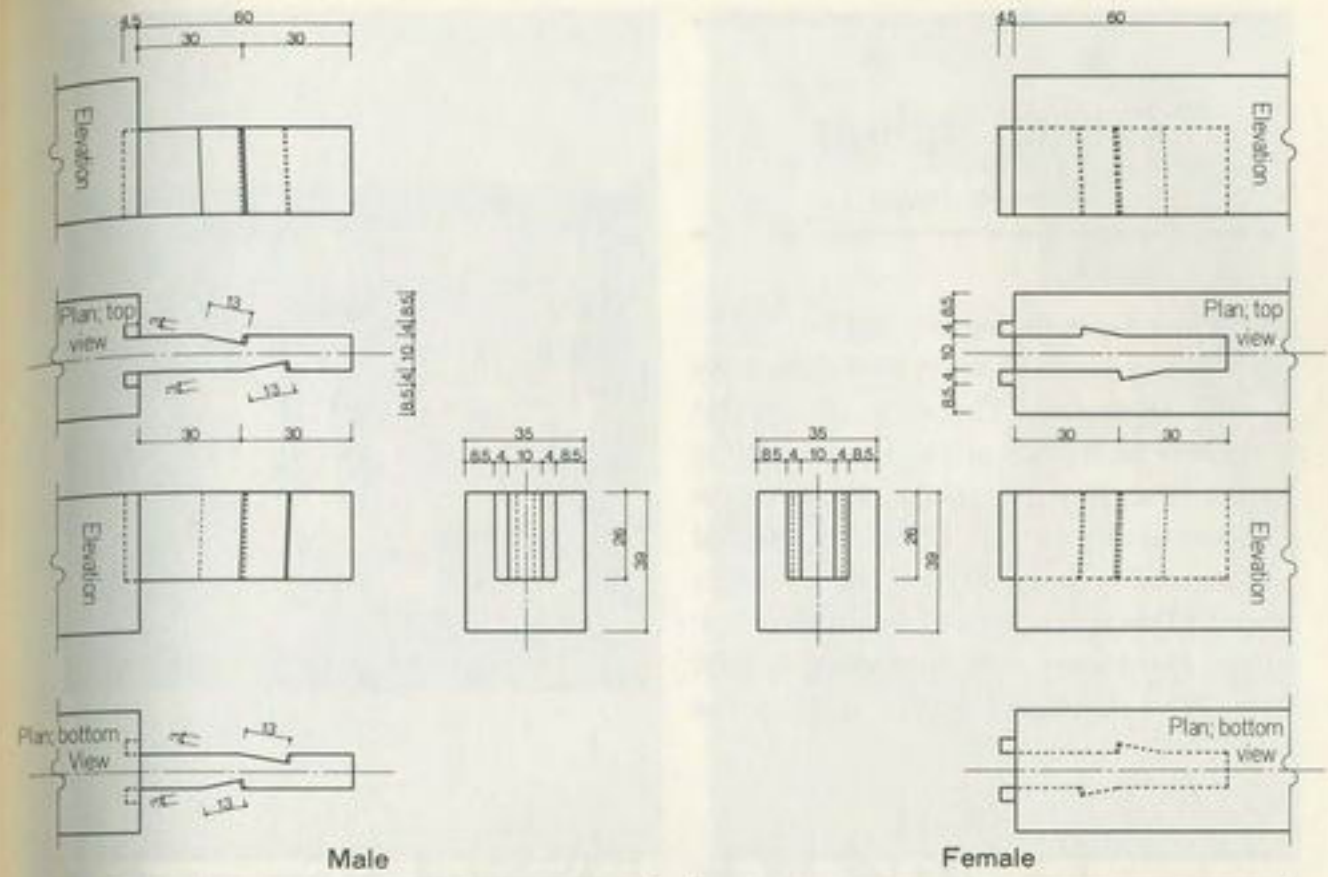
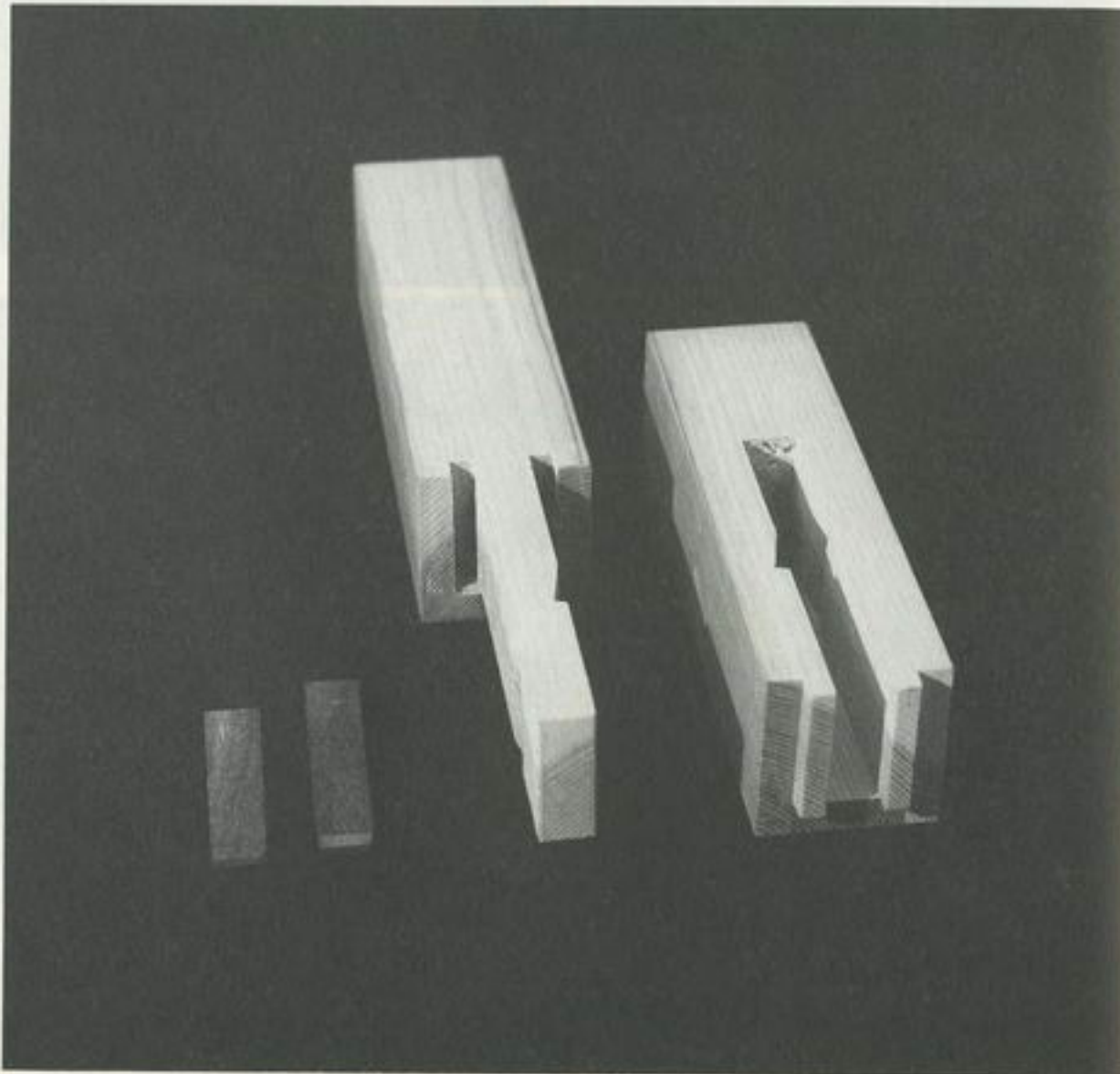
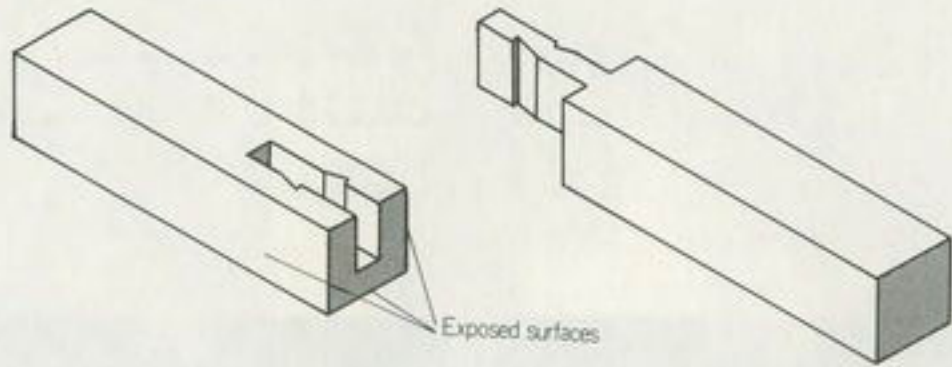

1 Male and female

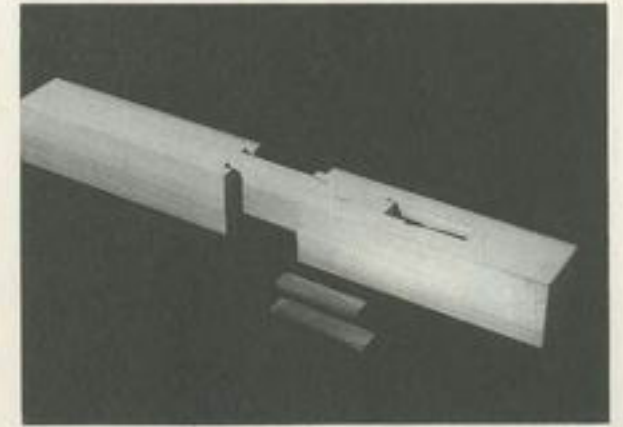

2 The male slides into the female.

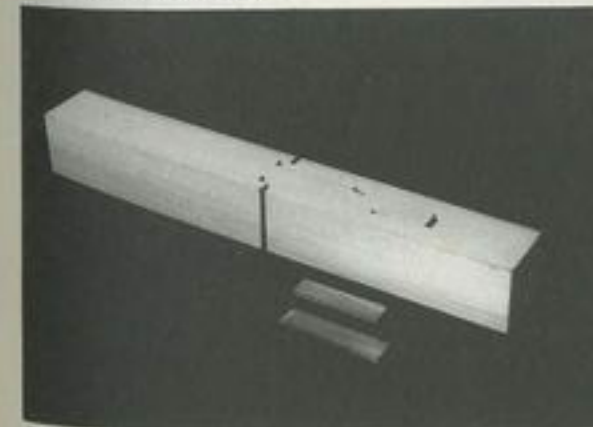

3 Same

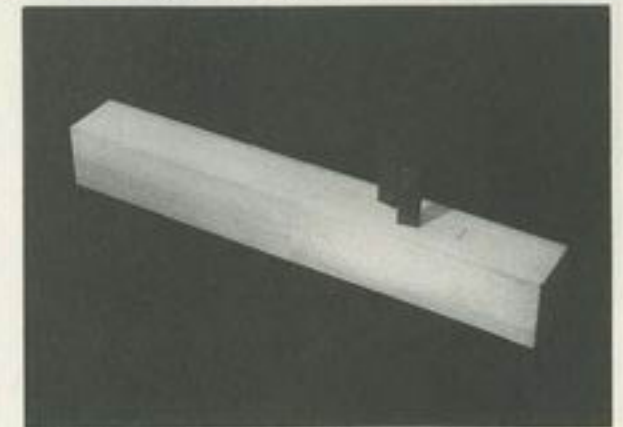

4 The splice is completed by inserting two keys.

● SPLICE 09 ●

Column splices

(Hashira tsugi)

(1) Four faces gooseneck splice

Two goosenecks are carved diagonally across the section. The male and female slide over each other at 45° to assemble the splice. The two goosenecks are small in relation to the size of the section. Skillful craftsmanship is required while manufacturing. This splice is suitable for large columns. Hard wood, such as zelkova, is often used. The peculiarity of this splice is the

identical gooseneck motif found on all faces of the column.

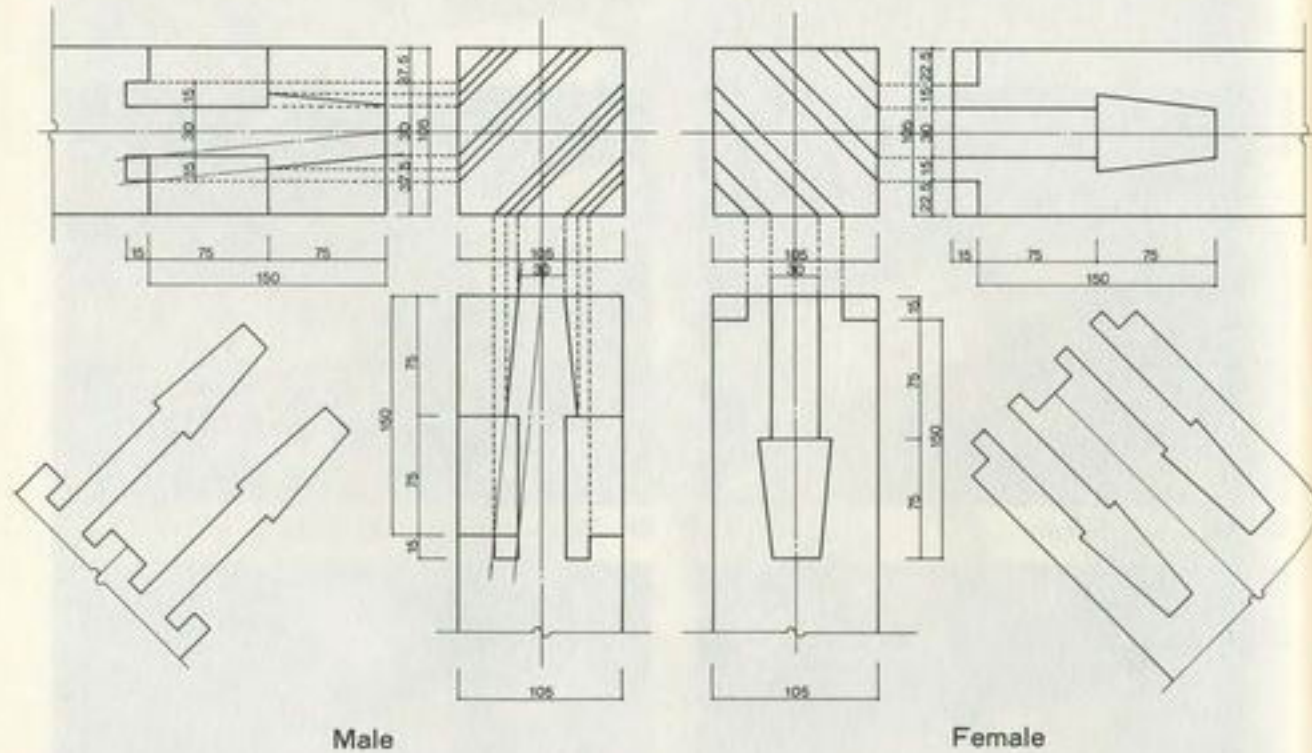
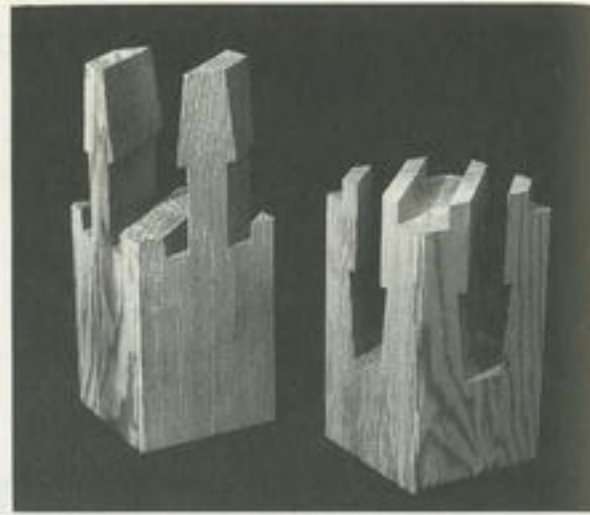

1 The male slides into the female diagonally.

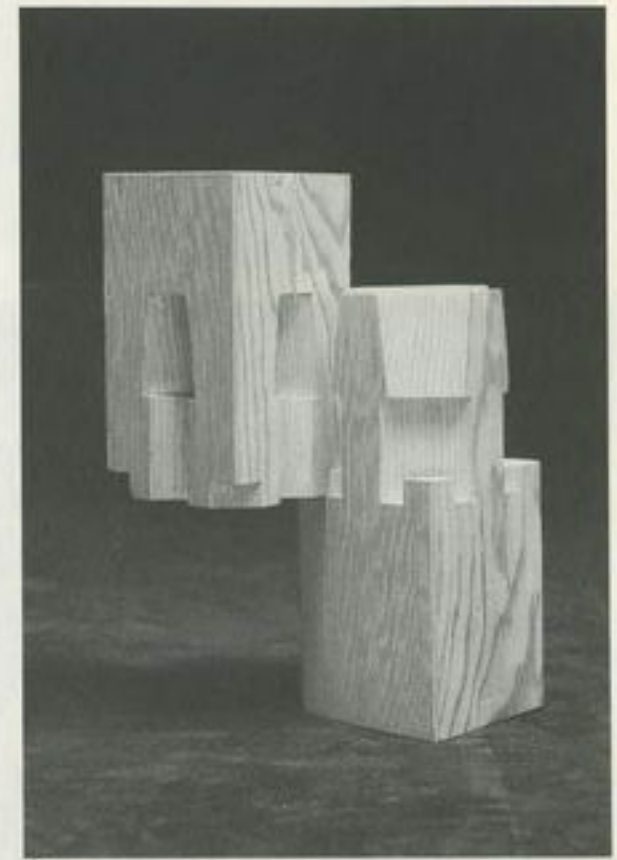

2 Same

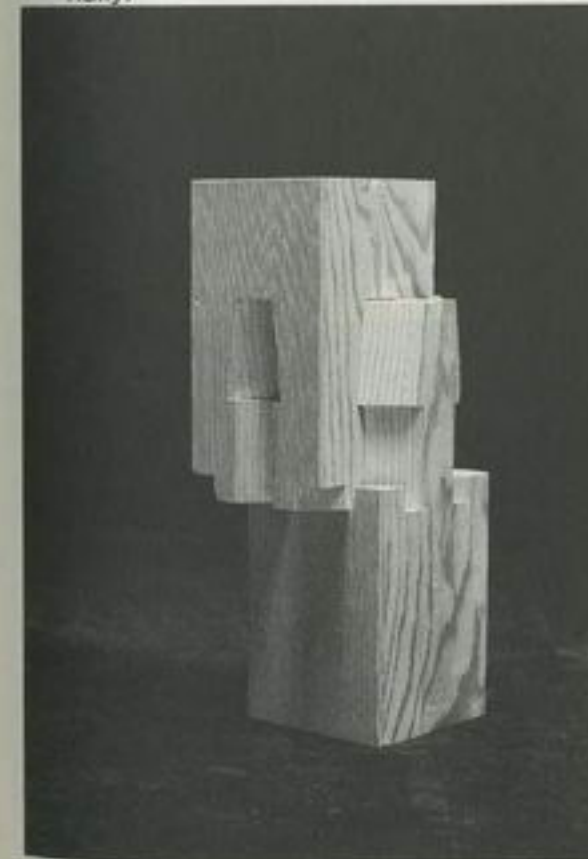

3 Same



4 Completion

(2) **Clam-shaped splice (kai no guchi)**

This relatively long splice has a few exclusive applications. Twice the length of the splice is required in assembling which is very inconvenient for underpinning. It is usually reserved for splicing distinguished

elements such as the central column in a pagoda. Both ends exhibit a "French type" tenon and mortise pattern. Finally to stiffen the assembly, a steel ring may slide over the joint. The splice is polished with sandpaper.

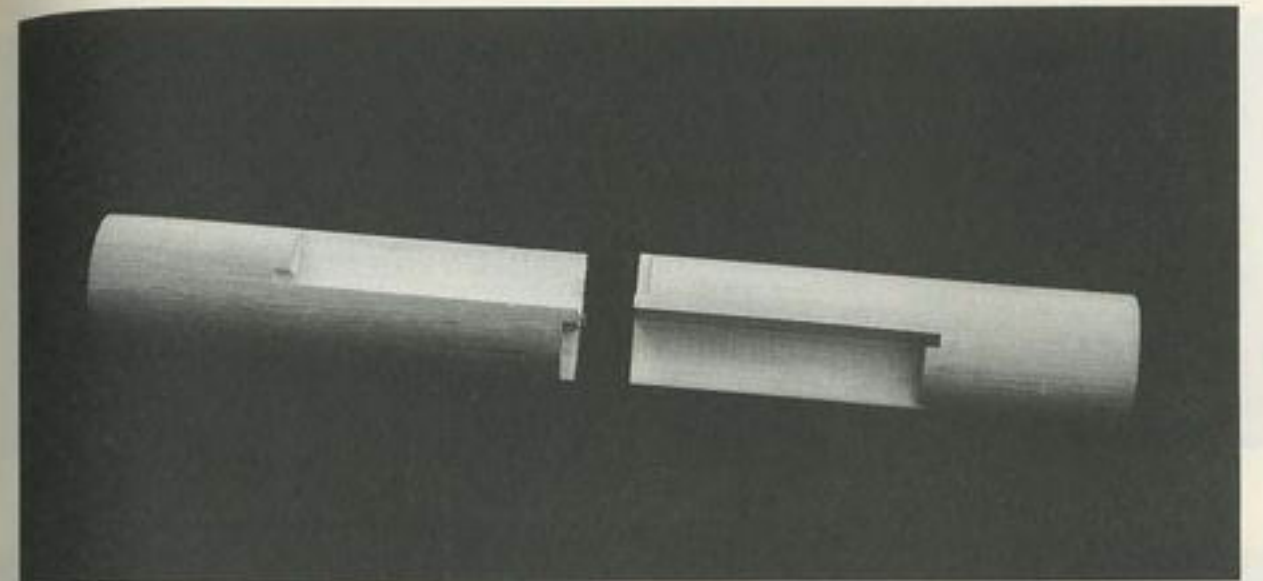
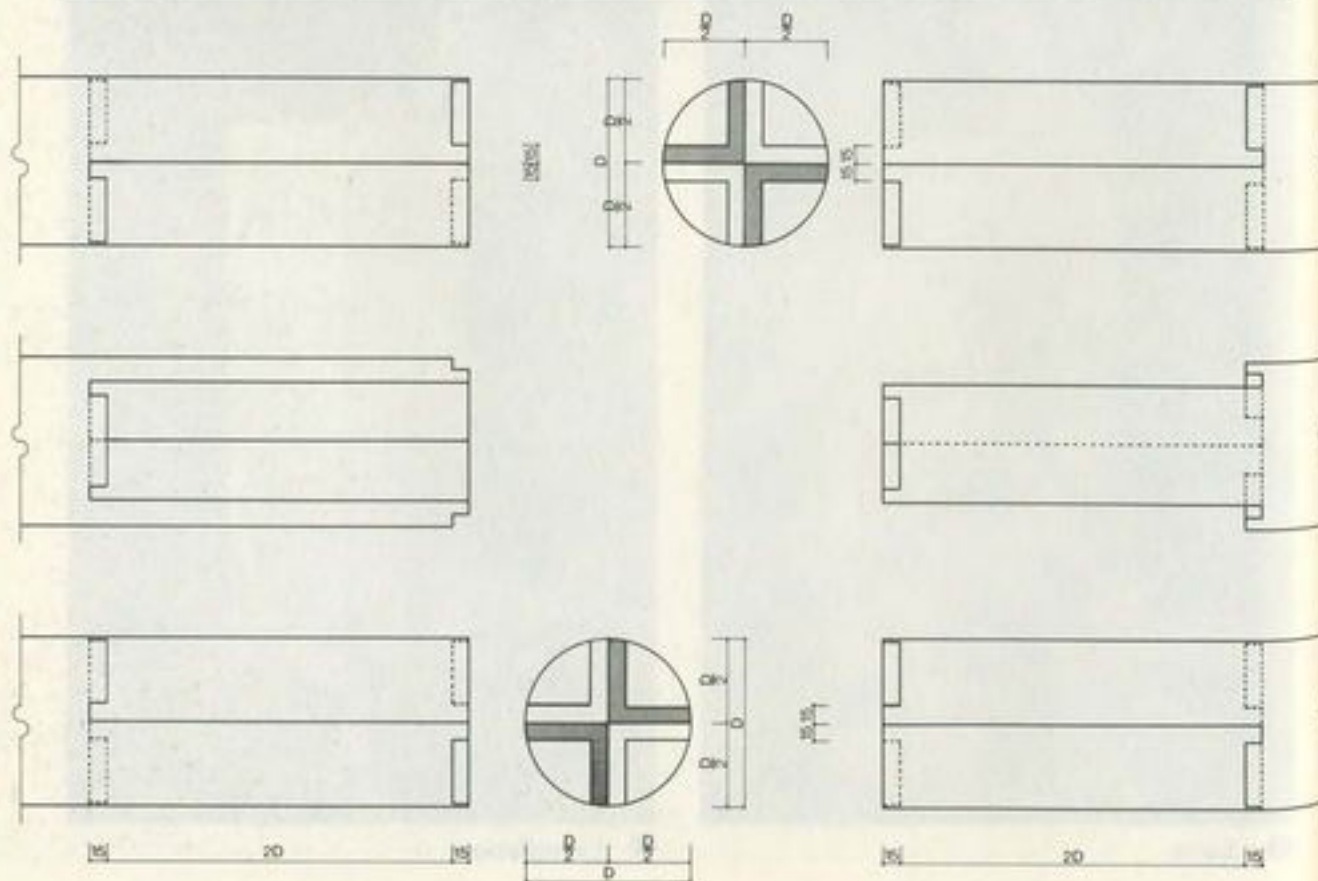
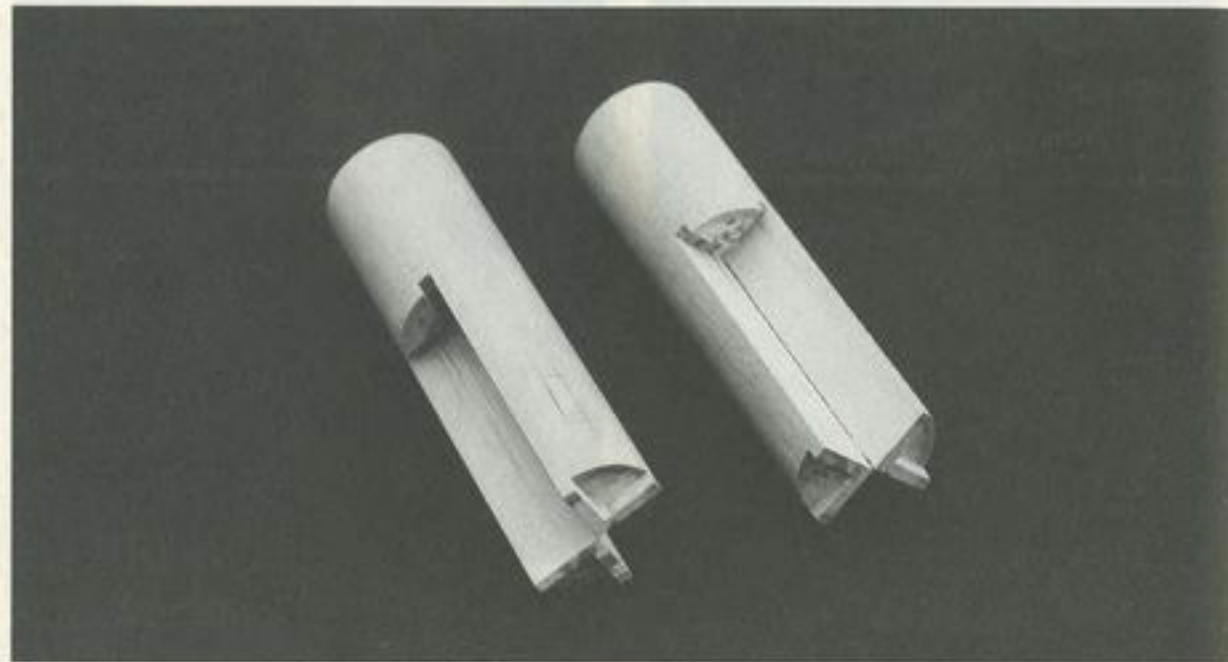

① Upper wood and lower wood

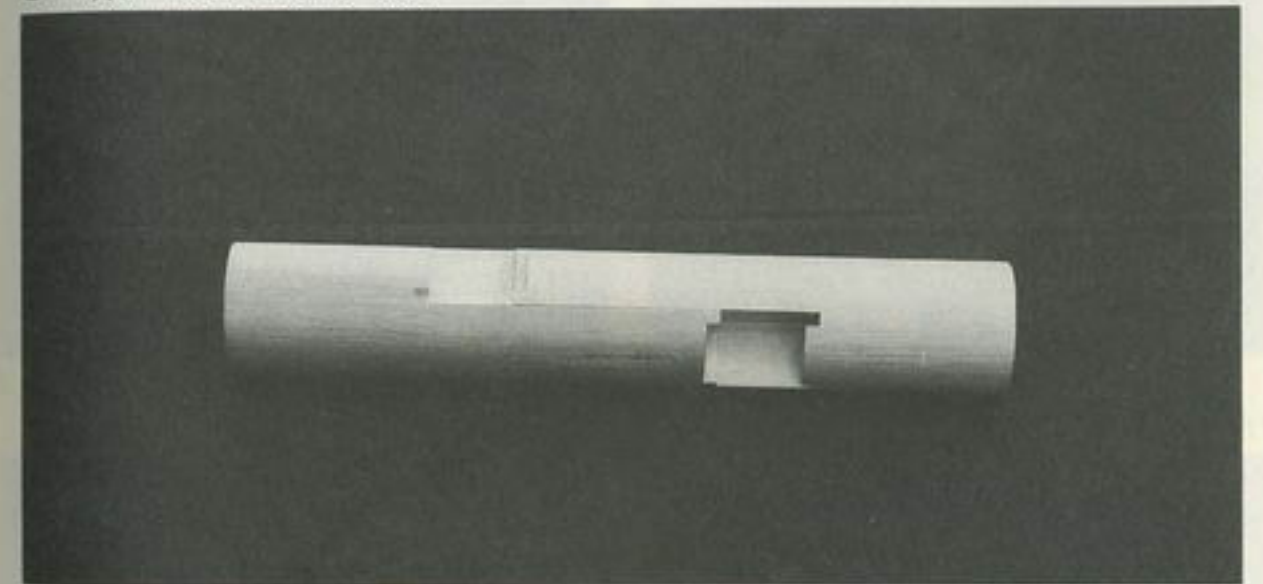

② Assembling the splice

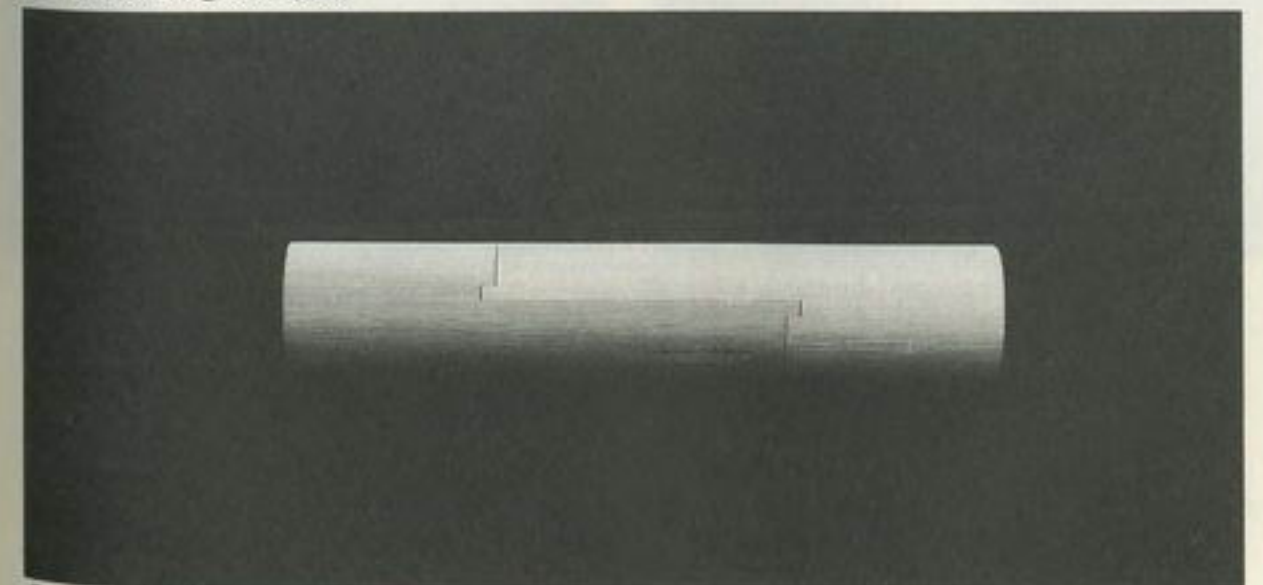

③ Completion

(3) **Blind splice (hako tsugi)**

This splice is inferior in strength to the rabbeted oblique scarf splice because of the method used to lock the joint. A key contributes little to the sturdiness of the assembly compared to a draw pin. The key hole and the longitudinal joint line are positioned at the corner of the section making this splice very attractive on columns.

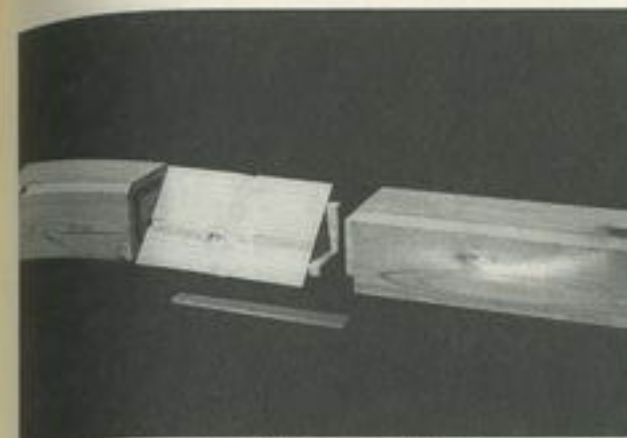
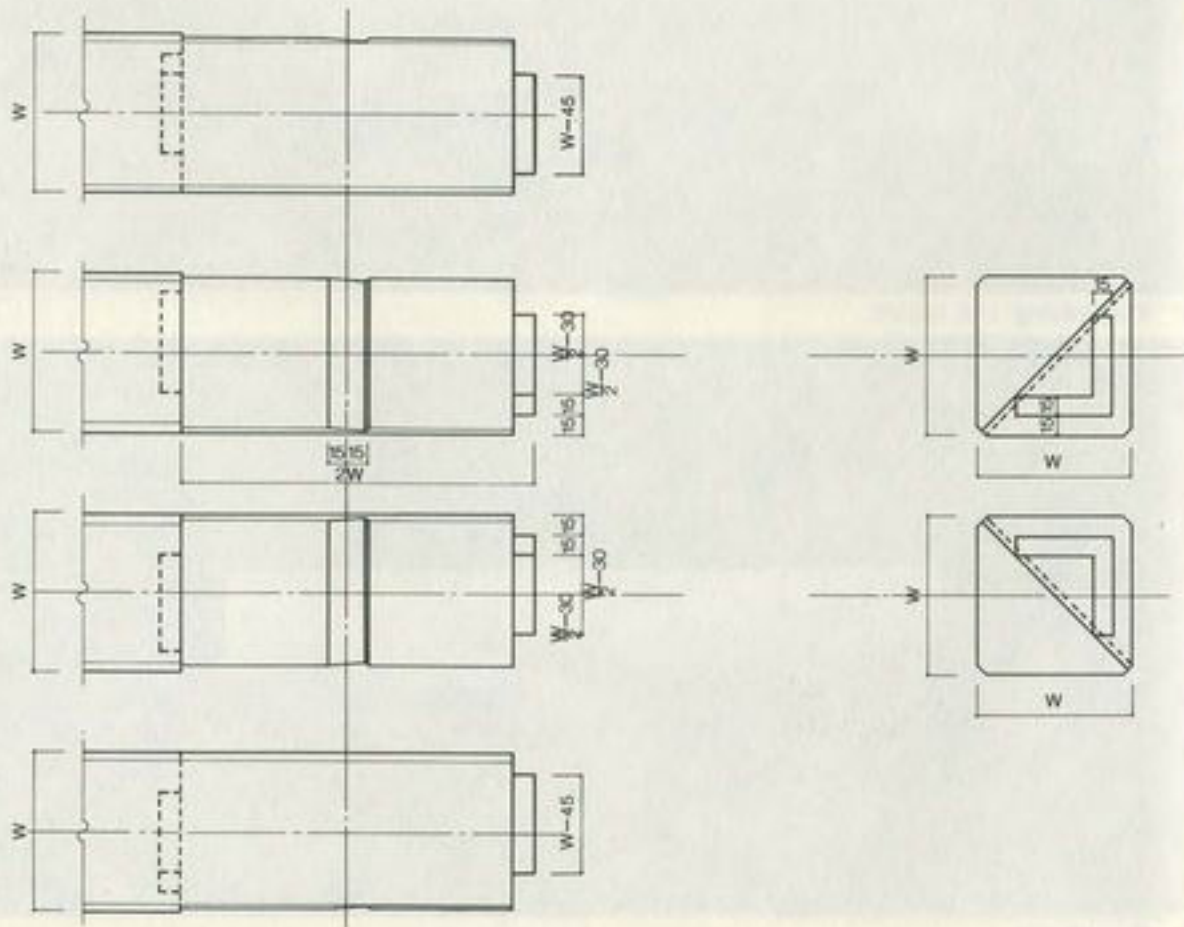
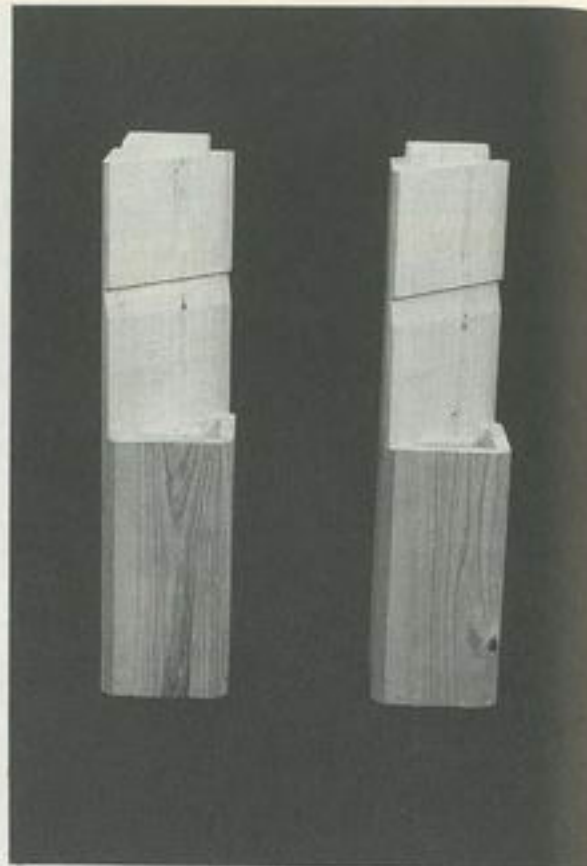

1 Upper wood and lower wood

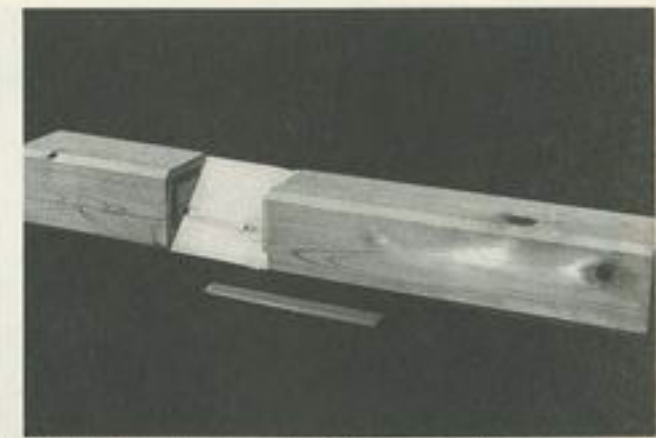

2 The upper wood slides over the lower wood.

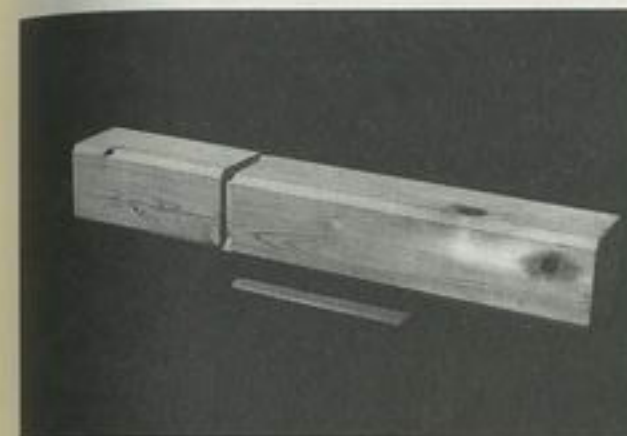

3 Same

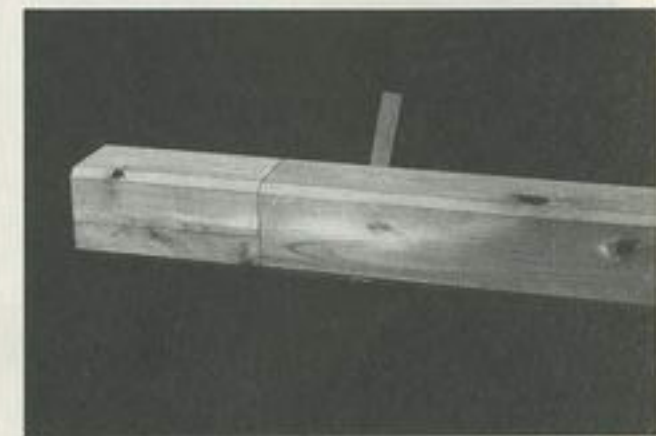

4 Inserting the key

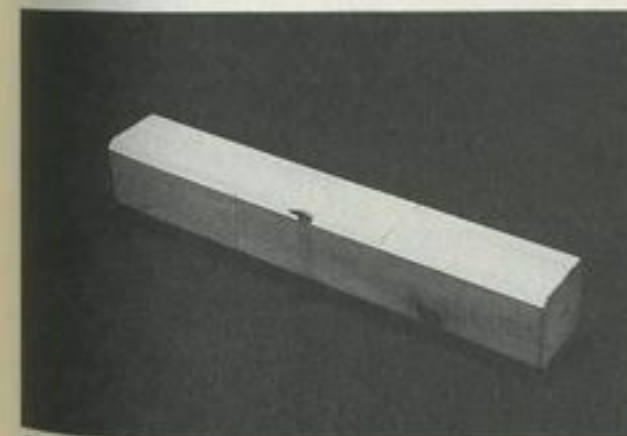

5 Same from a different perspective

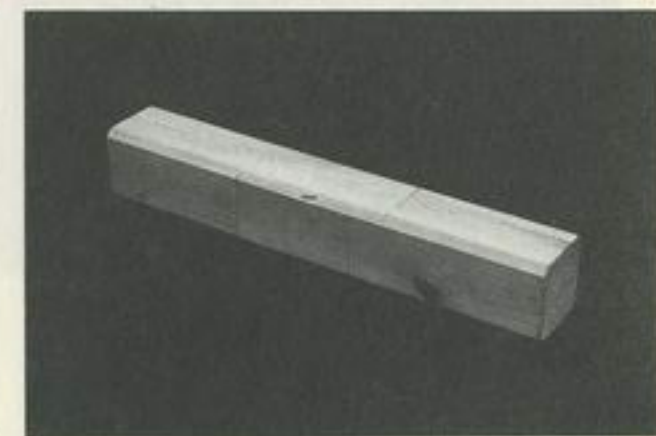

6 The splice is completed



X-ray picture A
The bright lines are the internal parts of the joint and display the outline of the dovetail.

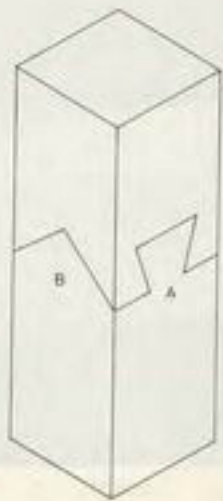

X-ray picture B
The axial black lines display the grain of the wood. The horizontal lines and the mountain-shaped lines are the upper face of the male on the inside and the seam on the outside surface.

CONNECTING JOINTS

● CONNECTING JOINT 01 ●

Half dovetailed joint

(Katasage ari)

The model depicts a wall tie connecting into a corner column. The column was split in half lengthwise to reveal the internal locking mechanism. Wall ties are usually covered up, however, traditional Japanese architecture sometimes call for exposed ties. The wedges, somewhat longer than necessary, are driven in as deep as possible to avoid rattling. First, the columns are erected, then the ties are inserted to prevent horizontal movement. Wedges are driven in after the erection is completed. Braced walls help resisting horizontal earthquake loading in Japanese wood architecture. The half

dovetail connects a single tie into a corner column. The diagram below shows a tie connecting into a column from two opposite sides.

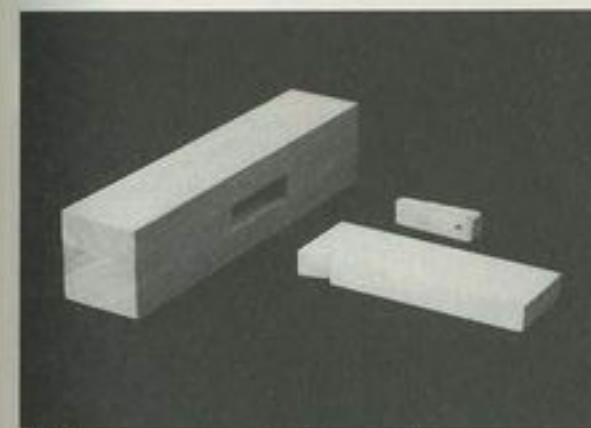
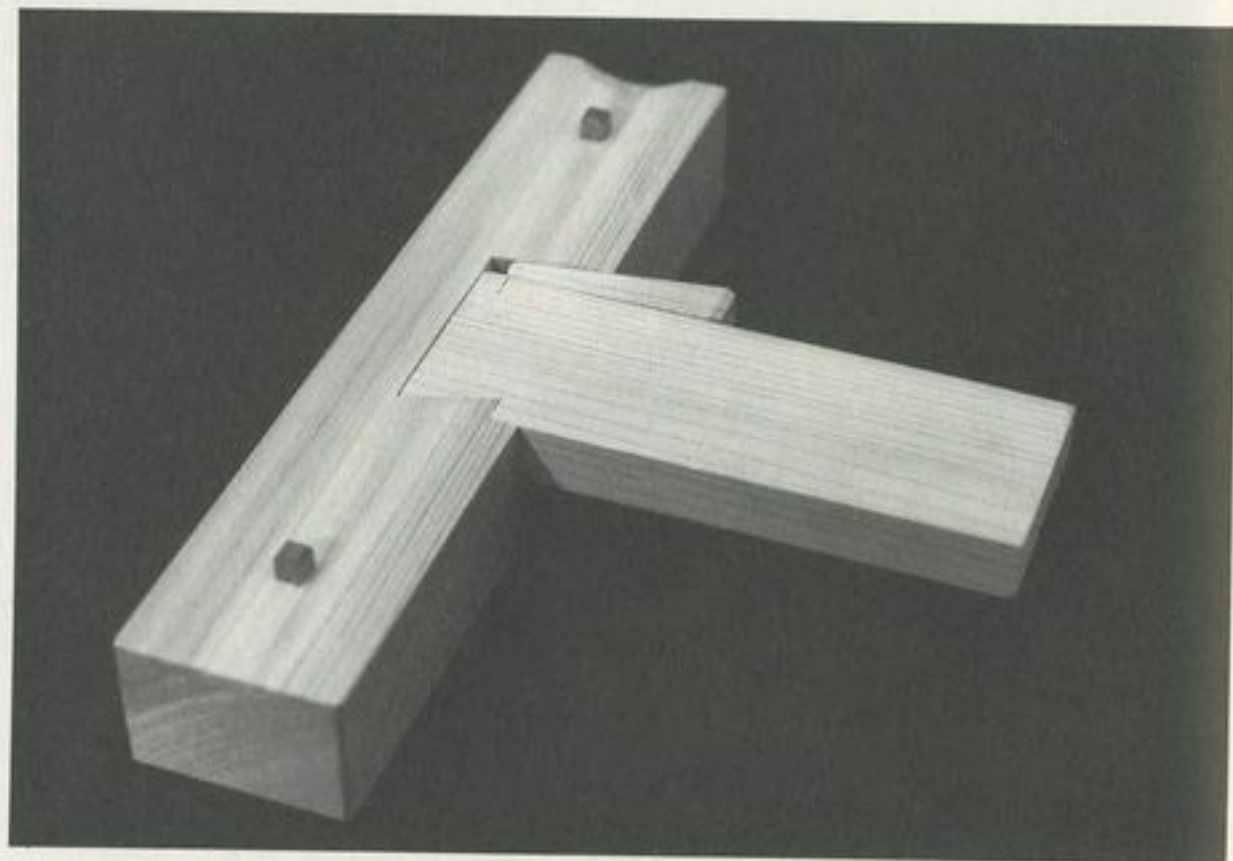
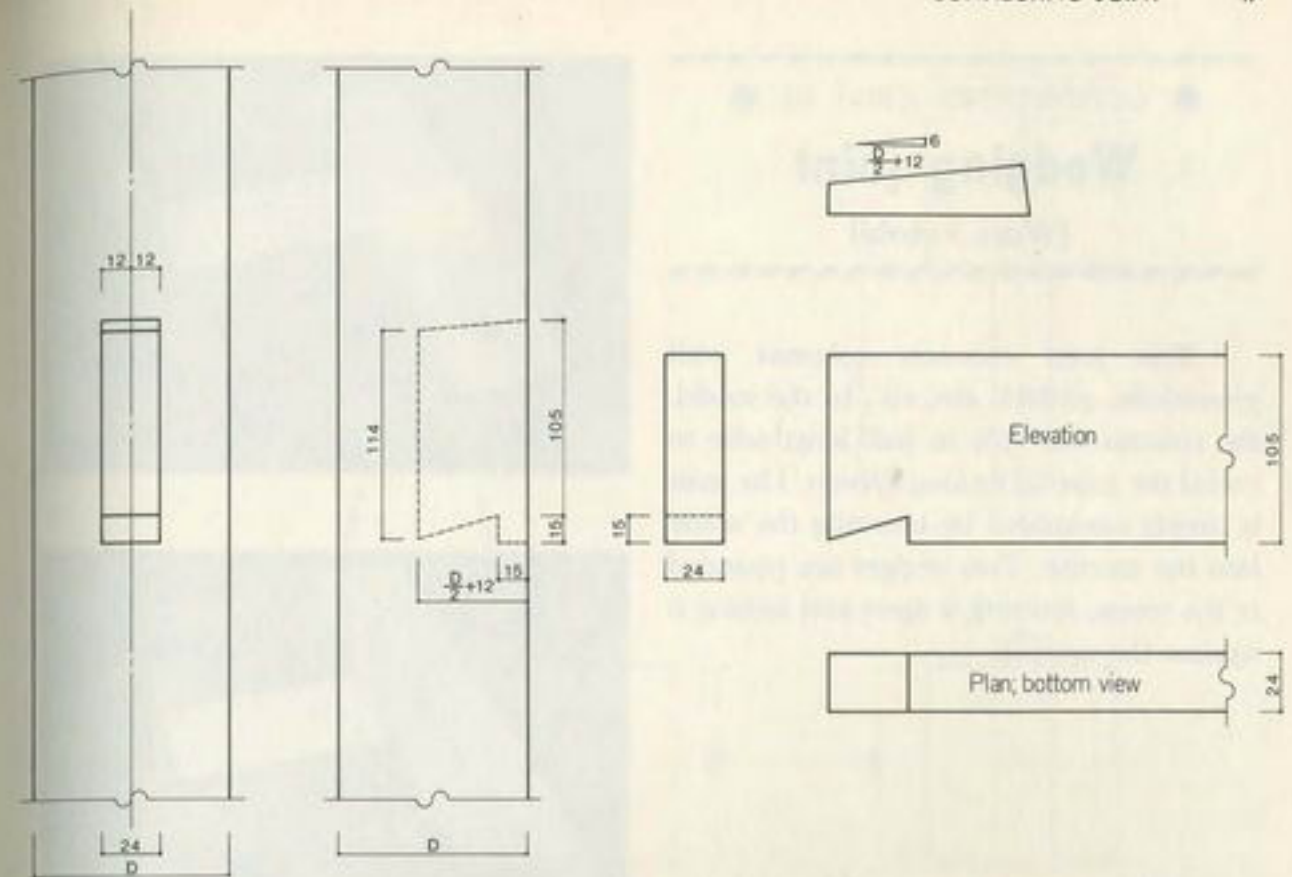
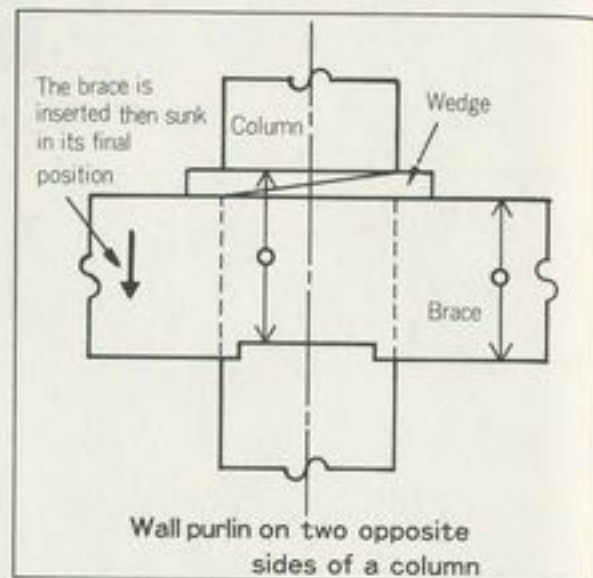

① Arrangement of the members

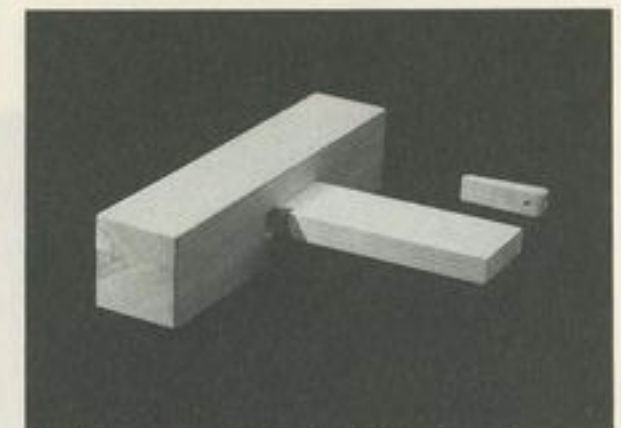

② The brace is inserted into the slot.

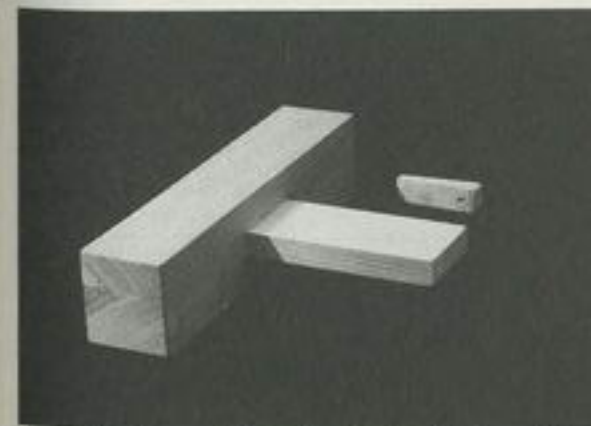

③ The brace is inserted in its final position opening a space for a wedge.

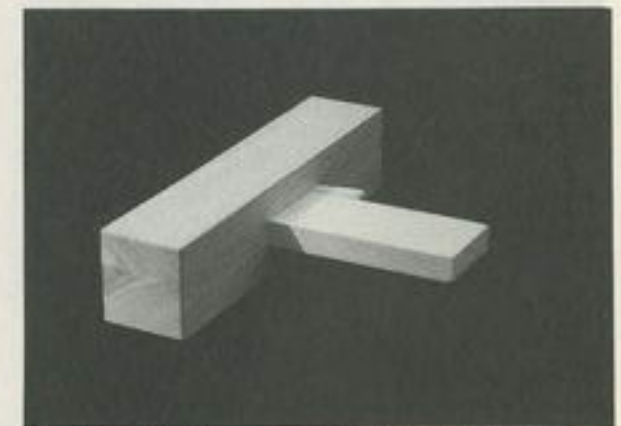

④ The joint is completed by driving in the wedge.

● CONNECTING JOINT 02 ●

Wedging joint

(Wari kusabi)

This joint connects columns with groundsills, girders, girt, etc. In the model, the column was split in half lengthwise to reveal the internal locking system. The joint is simply assembled by inserting the tenon into the mortise. Two wedges are pounded in the tenon, splitting it open and locking it against the mortise.

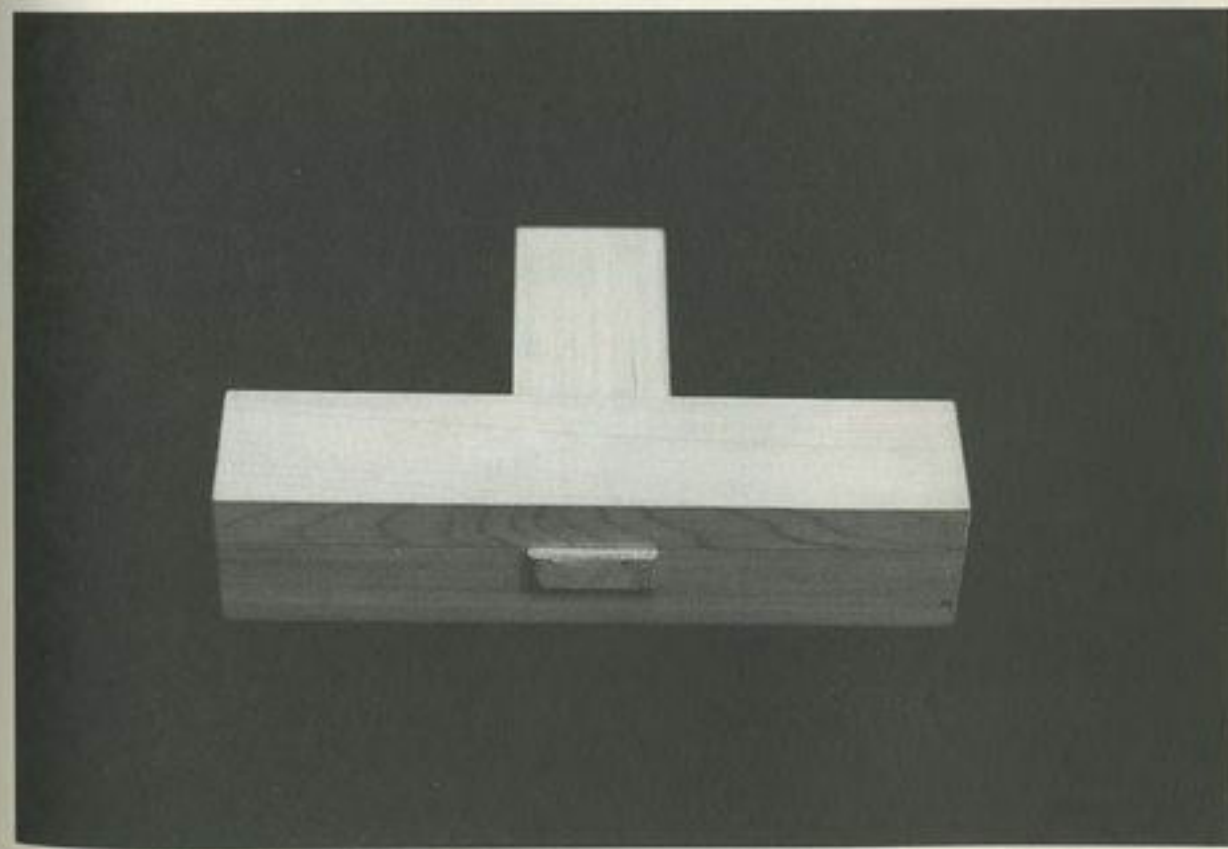
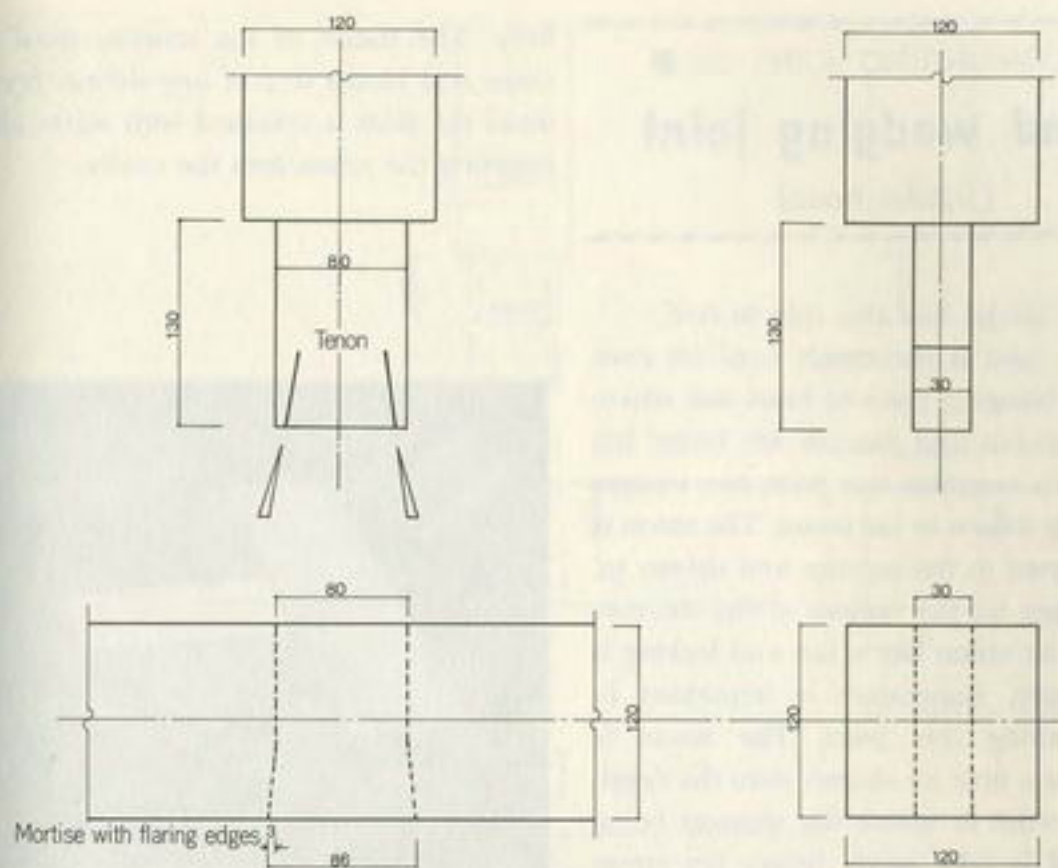
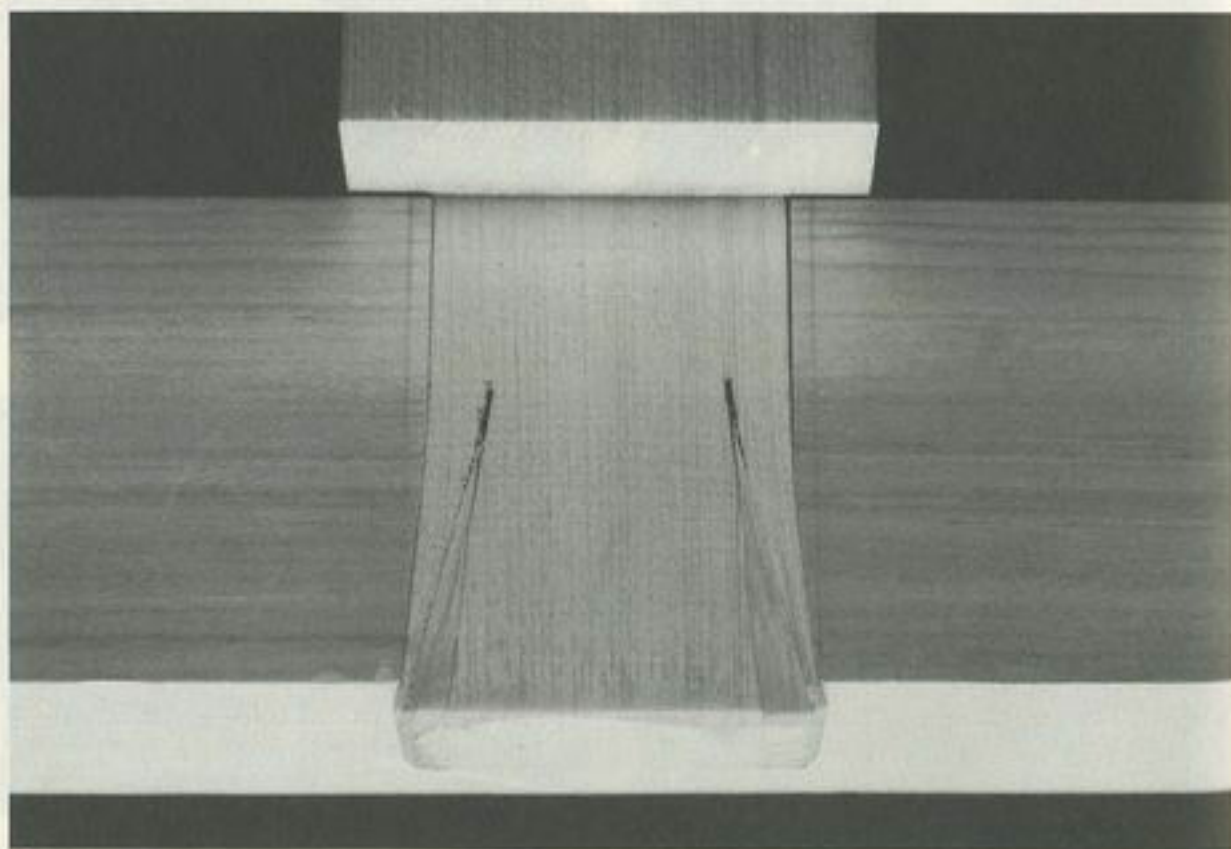
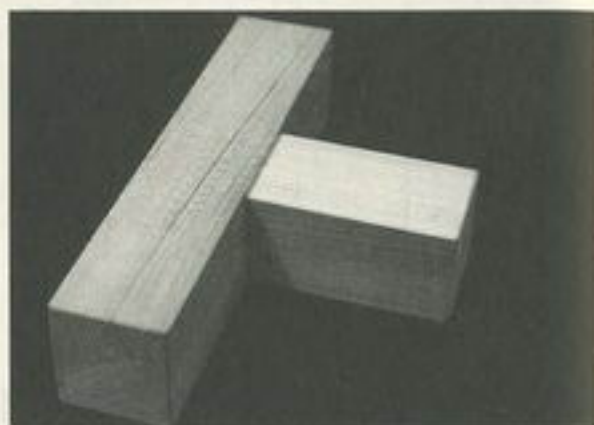
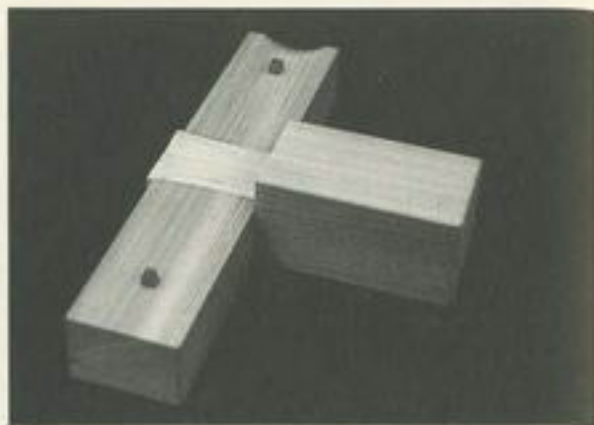

● CONNECTING JOINT 03 ●

Blind wedging joint

(Jigoku hozo)

This model was also split in half.

This joint is commonly used on eave brackets, hanging posts of lintel and whenever the tenon and mortise are better left hidden. To assemble this joint, two wedges are loosely driven in the tenon. The tenon is then inserted in the mortise and driven in. The wedges hit the bottom of the mortise, opening the tenon like a fan and locking it permanently. Experience is important in manufacturing this joint. The tenon is always cut a little bit shorter than the depth of the mortise to insure the element being assembled is fully inside before the tenon wedges itself permanently. Some techniques are helpful for assembling the joint success-

fully. The inside of the mortise must be clean and blown free of any debris. Sometimes the joint is splashed with water after inserting the tenon into the cavity.

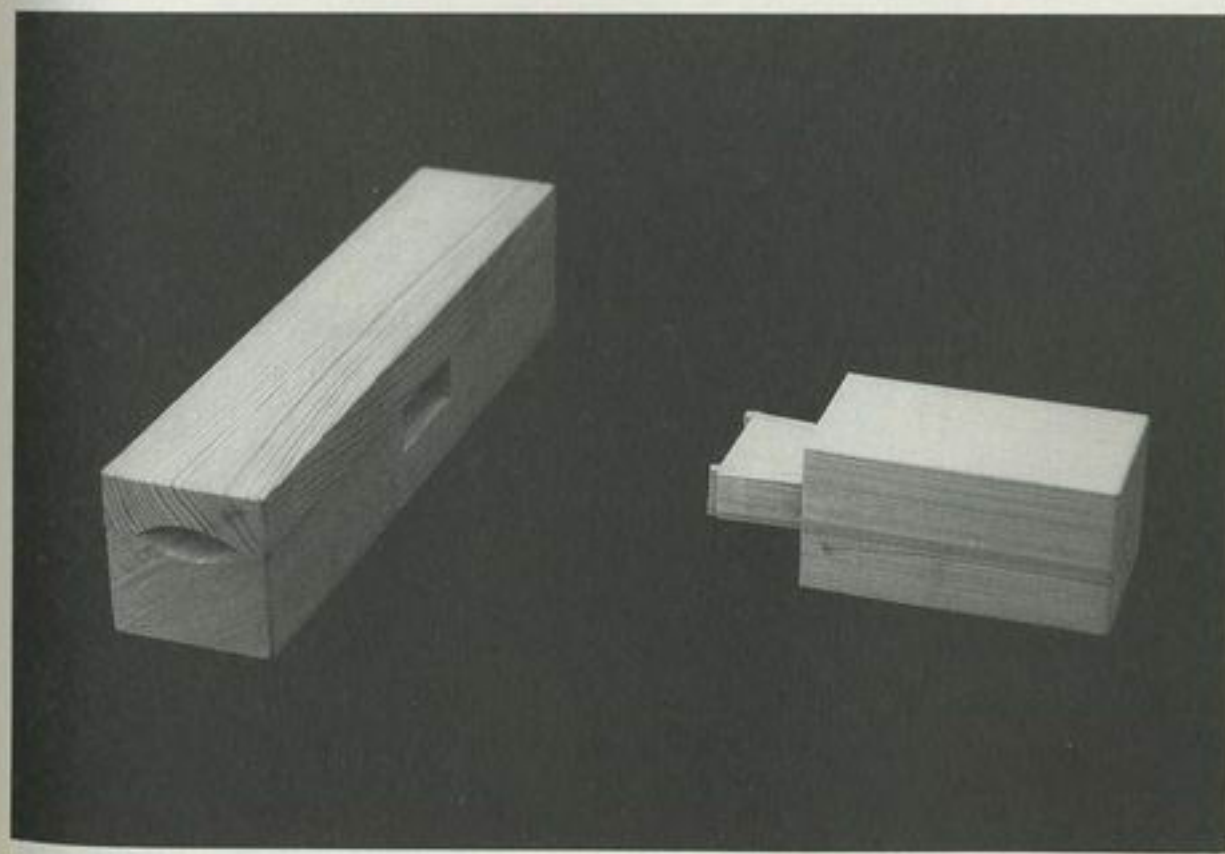
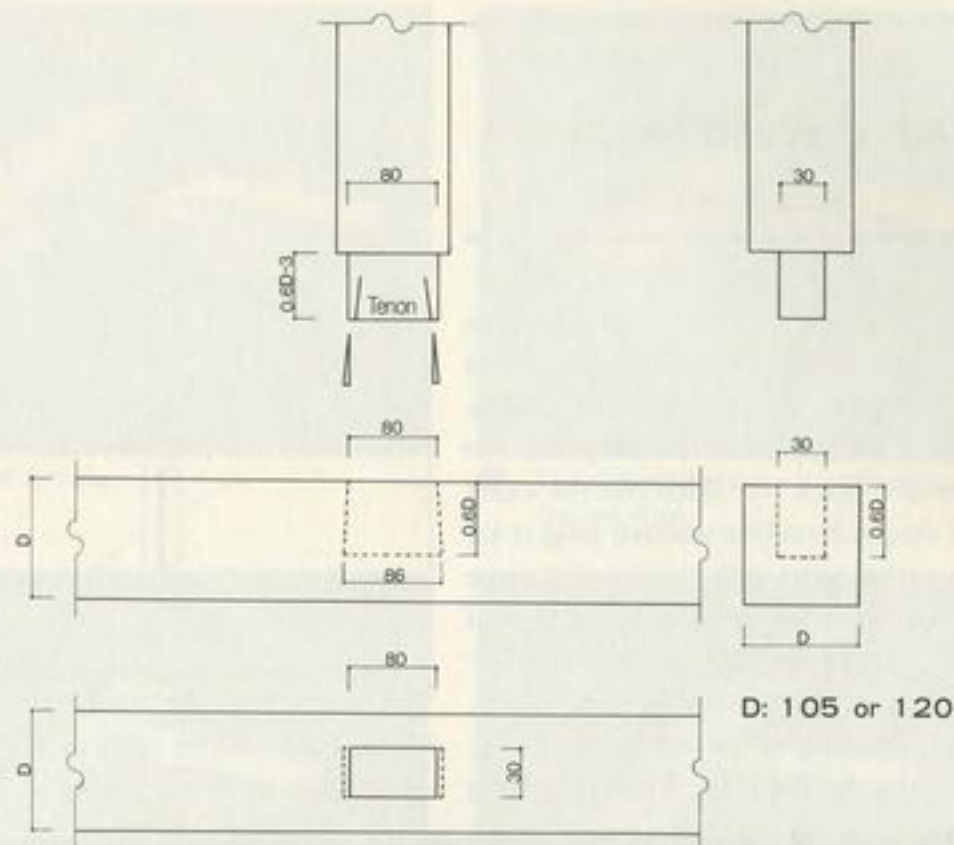
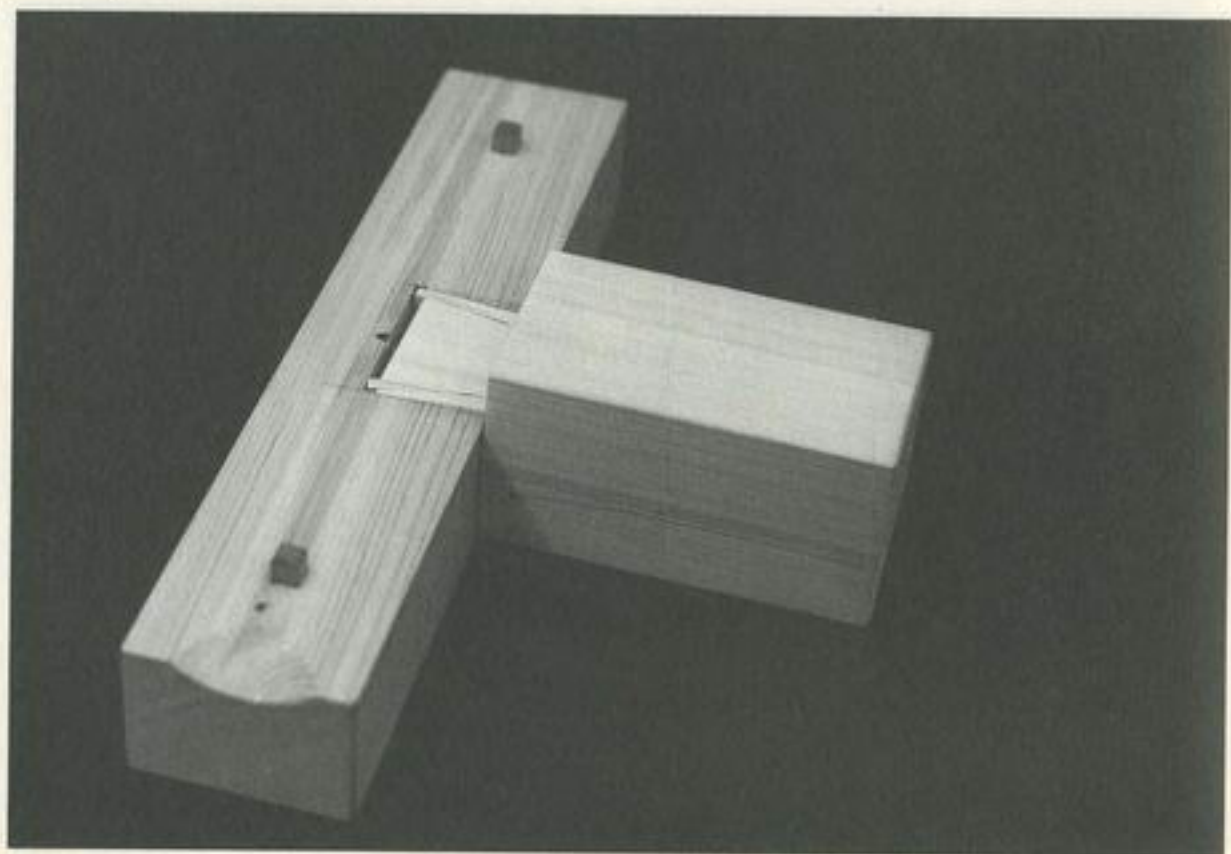
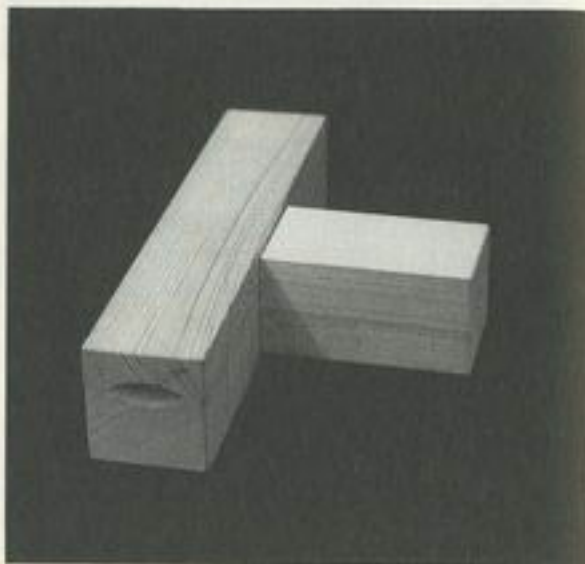

● CONNECTING JOINT 04 ●

Housed dovetailed joint

(Okuri ari)

This joint is frequently used on hanging posts (tsurizuka). At first the dovetail is inserted in the larger opening of the mortise (area A) and then shifted sideways into the narrower slot (area B) which has the exact inverted shape. Finally a wooden plug is set to ensure the joint will not easily come apart. Sometimes the dovetail is cut in half along the depth of the male end. The assembly proceeds as mentioned earlier. The larger opening of the mortise (area A) is now hidden by the male. The latter form

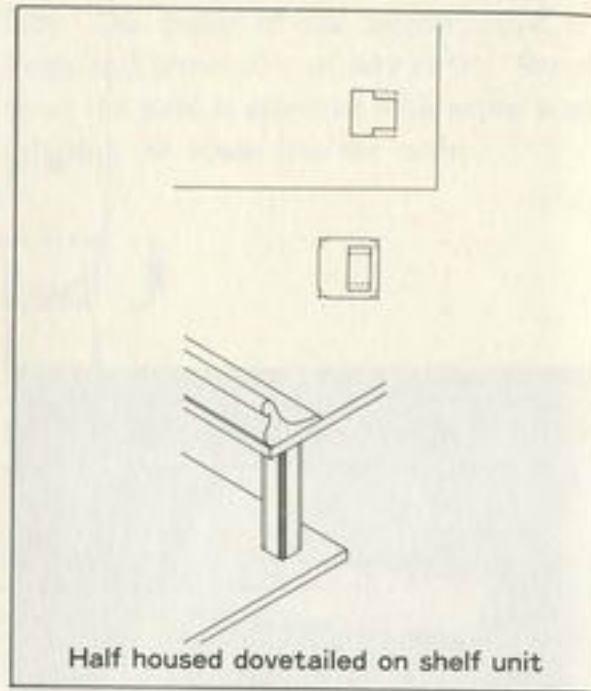

of this joint can be used to anchor the legs of shelving units on a floor.

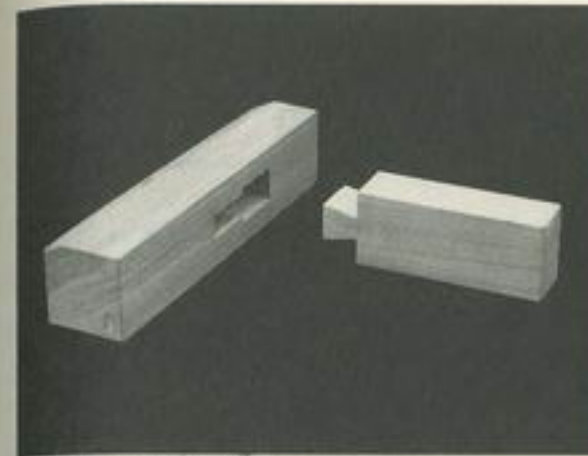
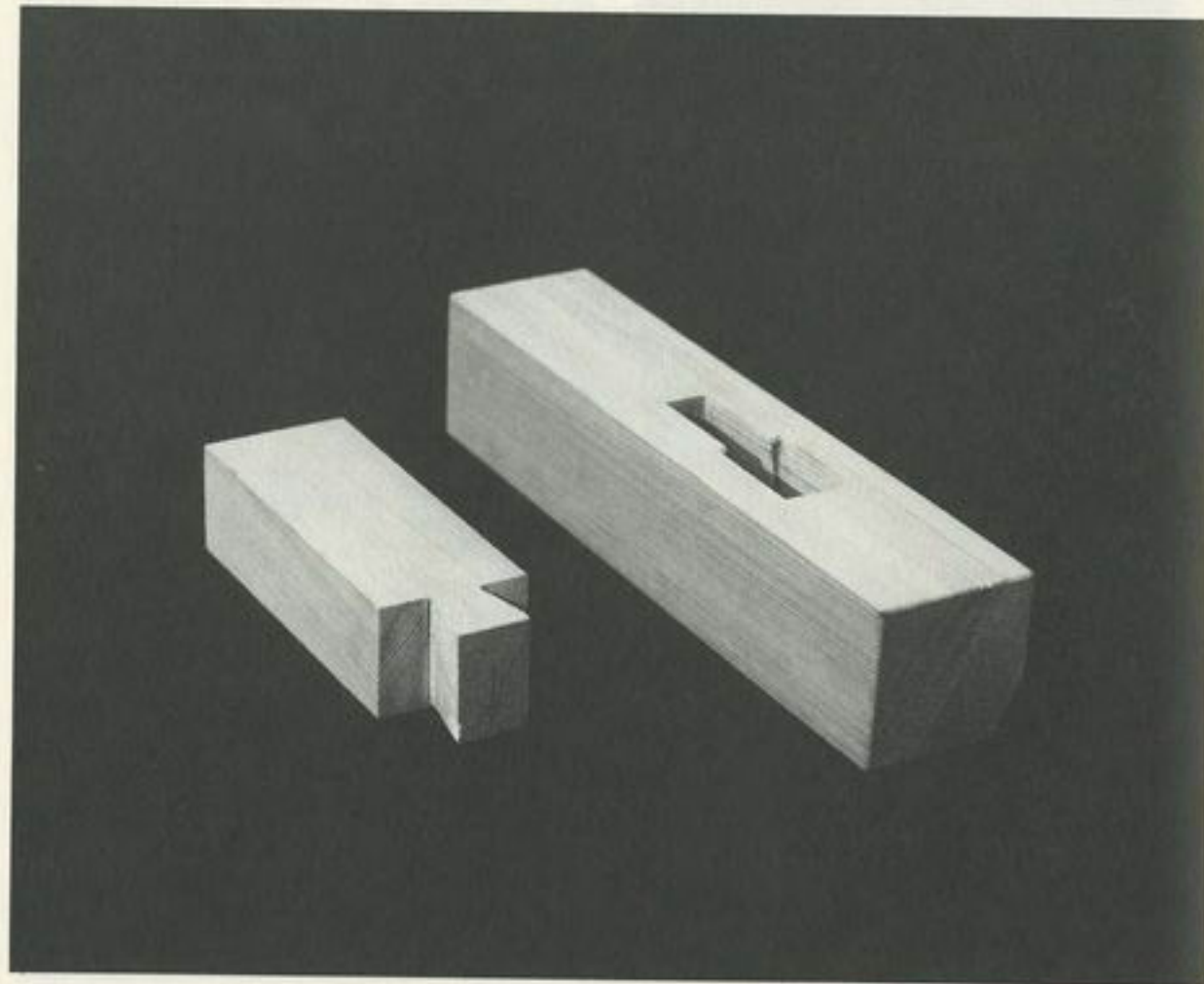

① Male and female

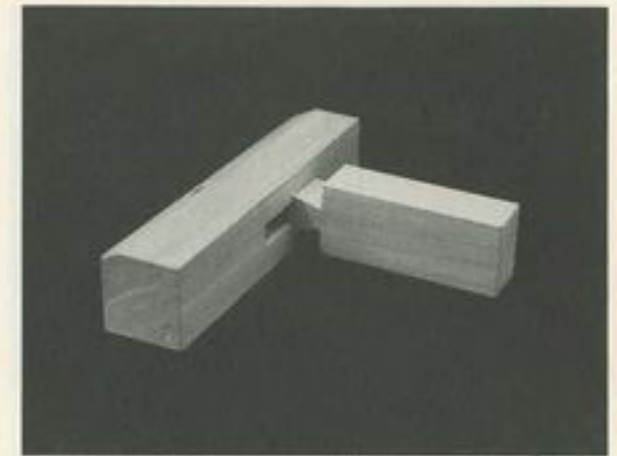

② The dovetail slides into the bigger end of the mortise.

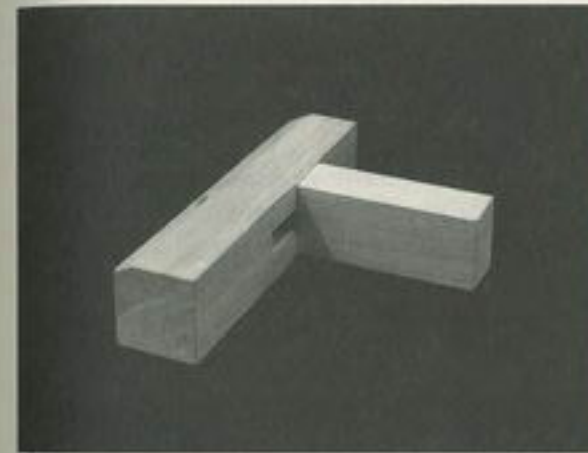

③ Same

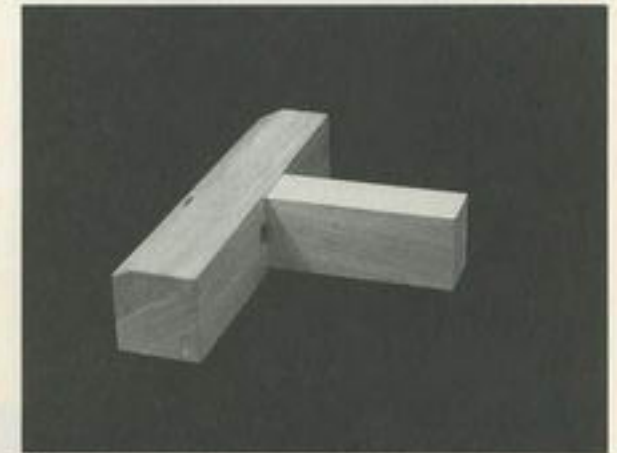

④ The dovetail is shifted into the smaller end of the mortise.

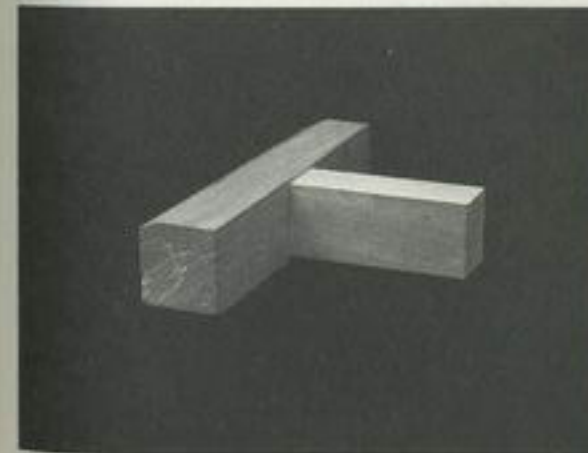

⑤ Assembled joint

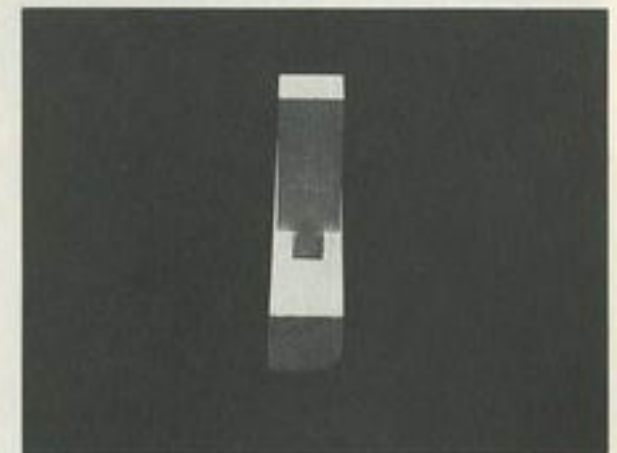

⑥ The plug is not shown for clarity.

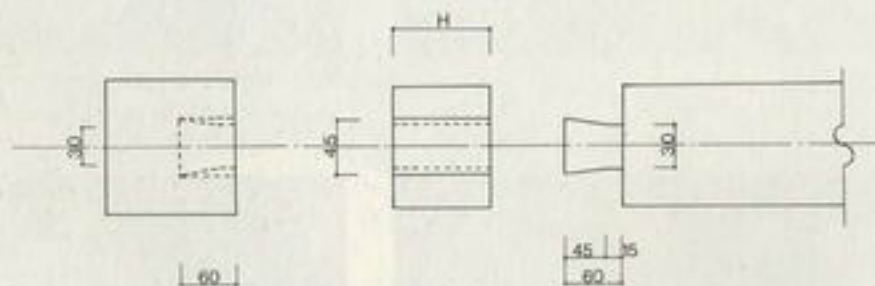
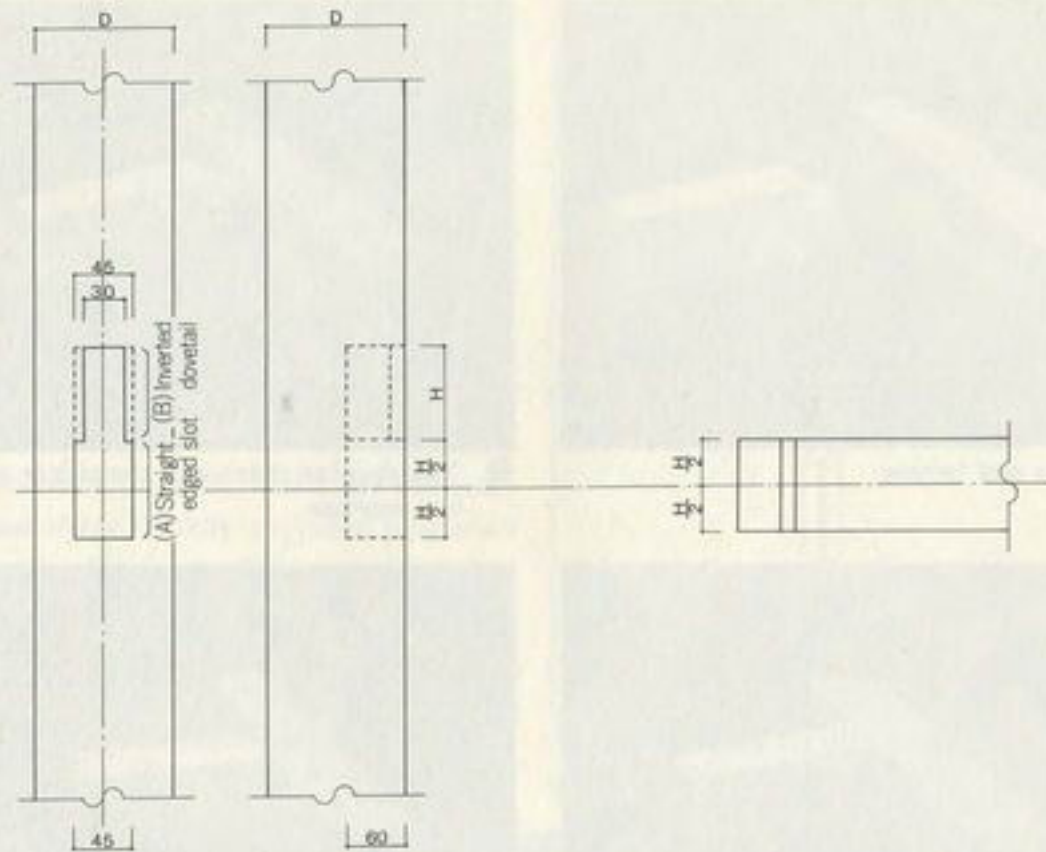

● CONNECTING JOINT 05 ●

Sumiyoshi double tenon

The upper tenon is a dovetail with flaring side walls. The lower tenon is rectangular with one surface tapering up. The joint is assembled by sliding the double tenon upward into the mortise at the same angle as the tapered surface of the lower tenon. Master Sumiyoshi learned of this joint from fellow craftsmen. An X-ray picture of the assembly shows some discontinuity making it not entirely satisfactory.

X-ray photograph showing a discontinuity after assembly

The lower tenon appears completely white suggesting an imperfect fit. White gaps can also be seen on the left and right side of the tapered tenon. A perfect fit after assembly ensures the integrity of a joint.

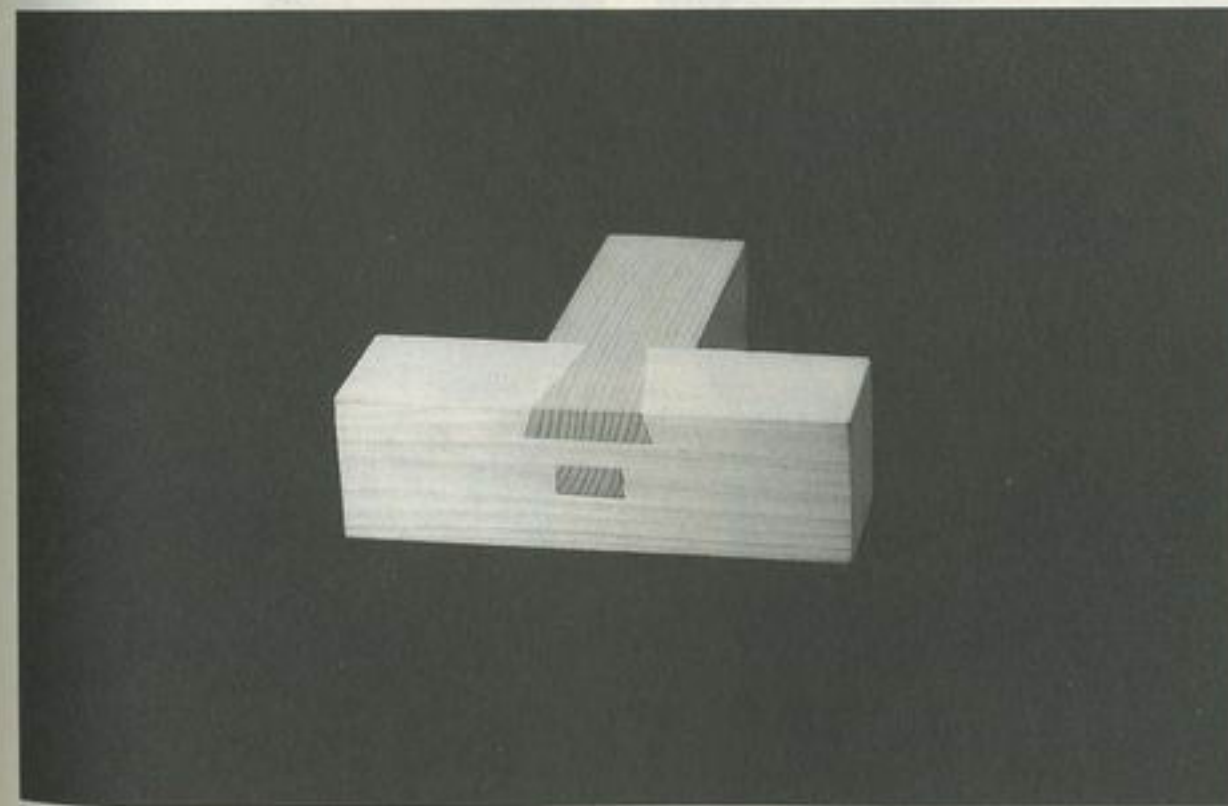
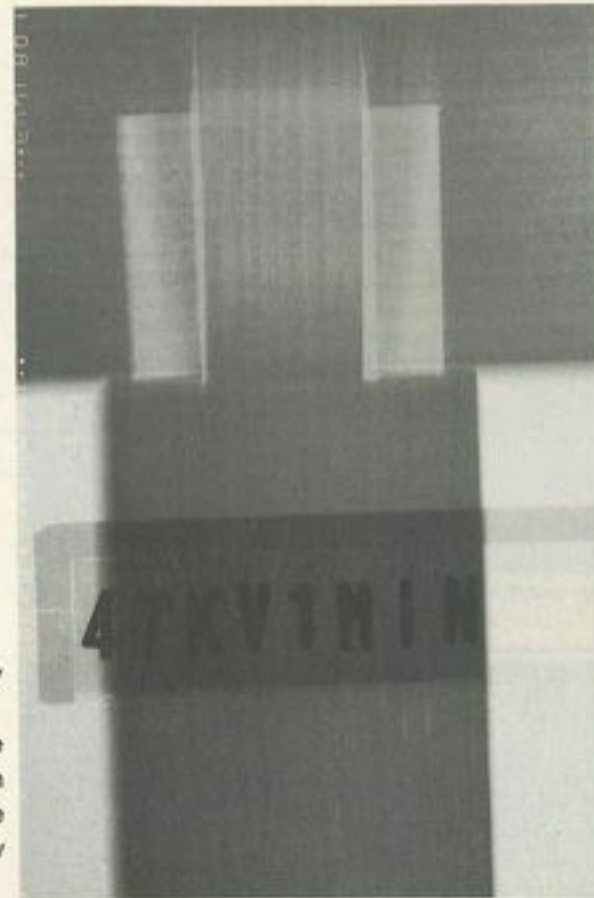

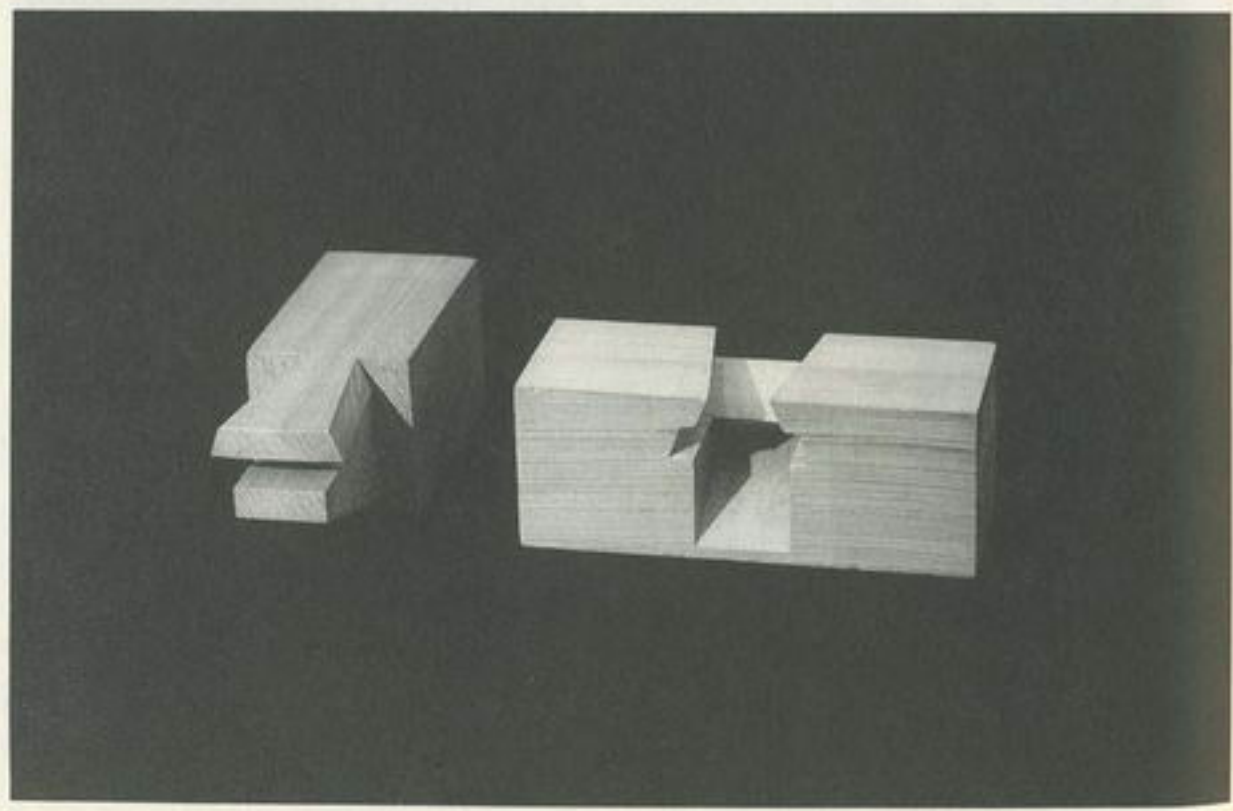
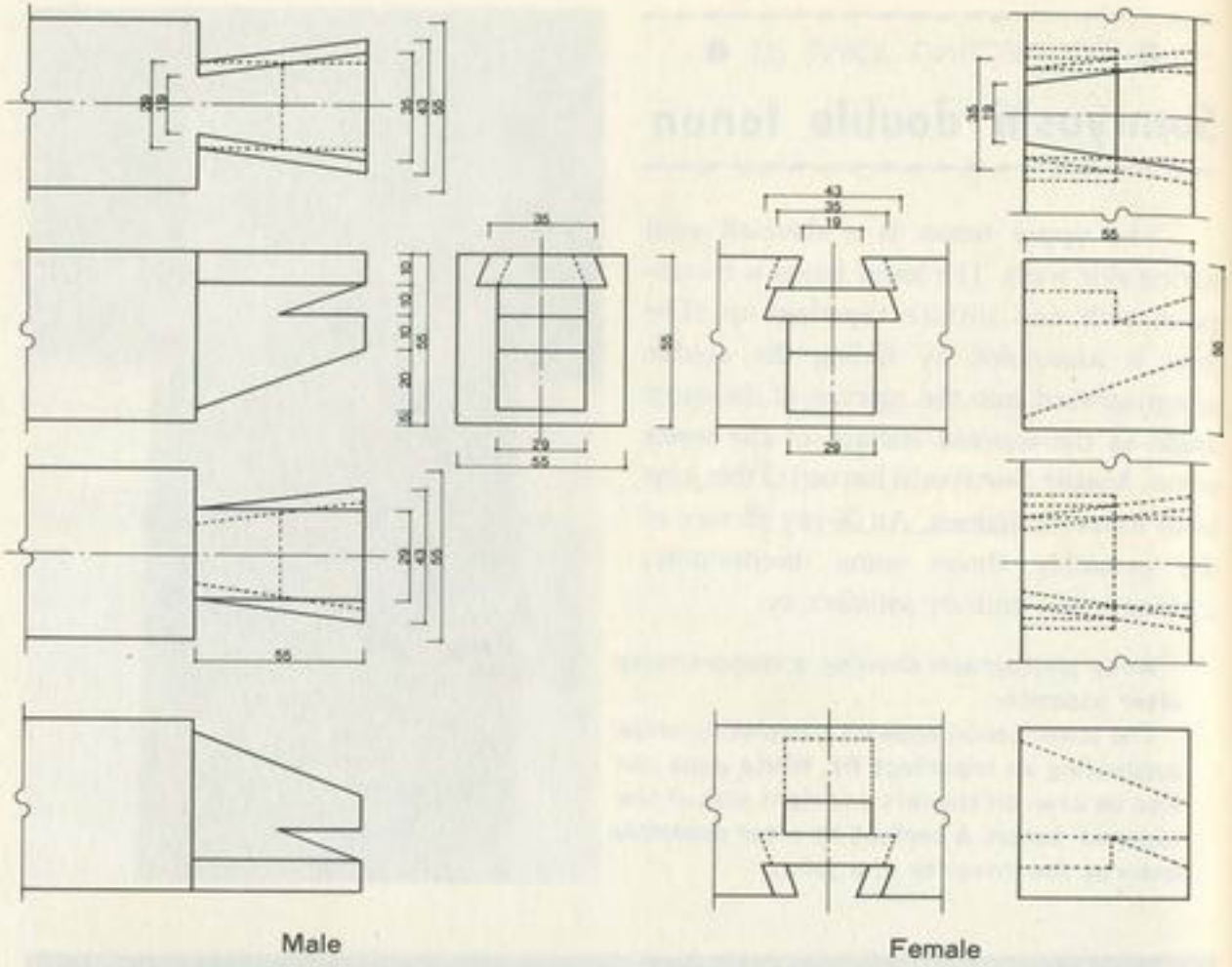

1 Male and female

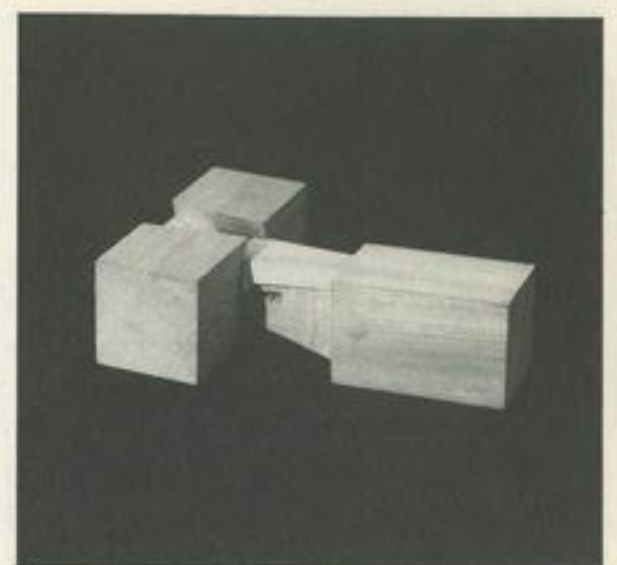

2 The male is inserted into the female at an angle.

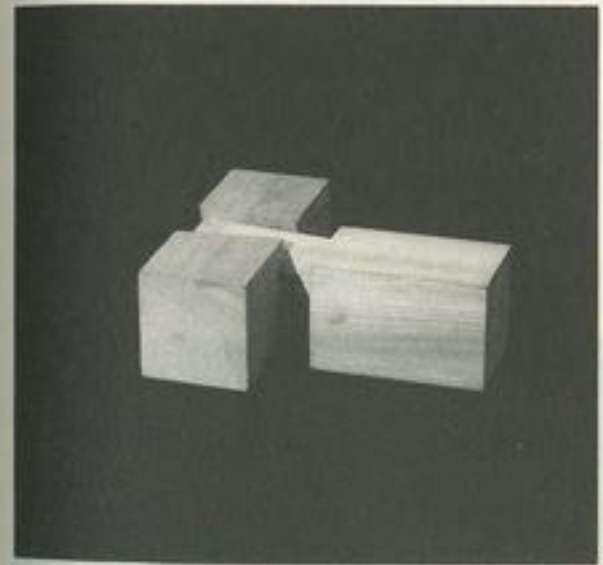

3 Same

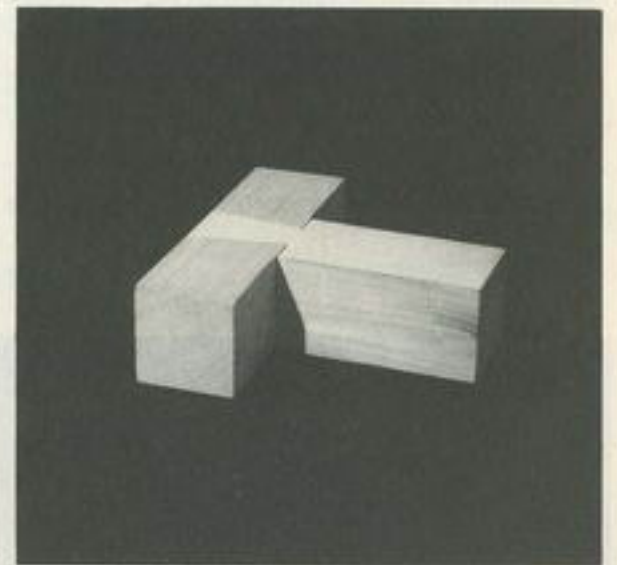

4 Assembled joint.

● CONNECTING JOINT 06 ●

Double plug

This assembly connects two beams on opposite faces of a column. The beams are spliced through the column. Larger splices (pole tenon) produce sturdier assemblies. The beam with the longer tenon is connected to the column first. The second beam is inserted and shifted forward until the lower tenons butt at the centre of the column. The connection between the beams and the column is completed before finishing the splice between the beams. In order to provide the joint with enough tensile resistance, two keys and a draw pin are driven in. One or the other would be insufficient by itself. It is important to tighten the

assembly before inserting pin and keys, otherwise the components could be exposed to excessively large stress.

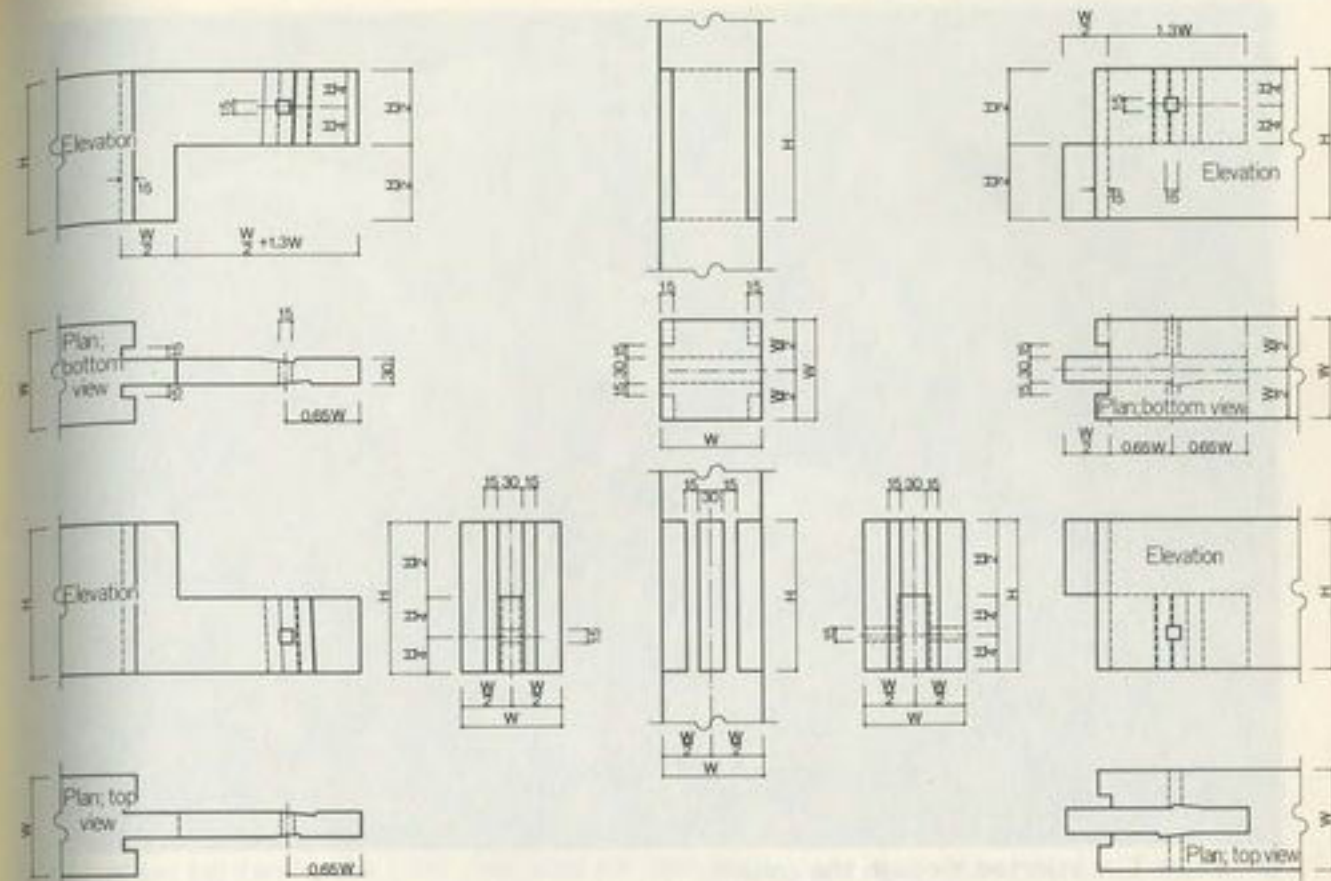
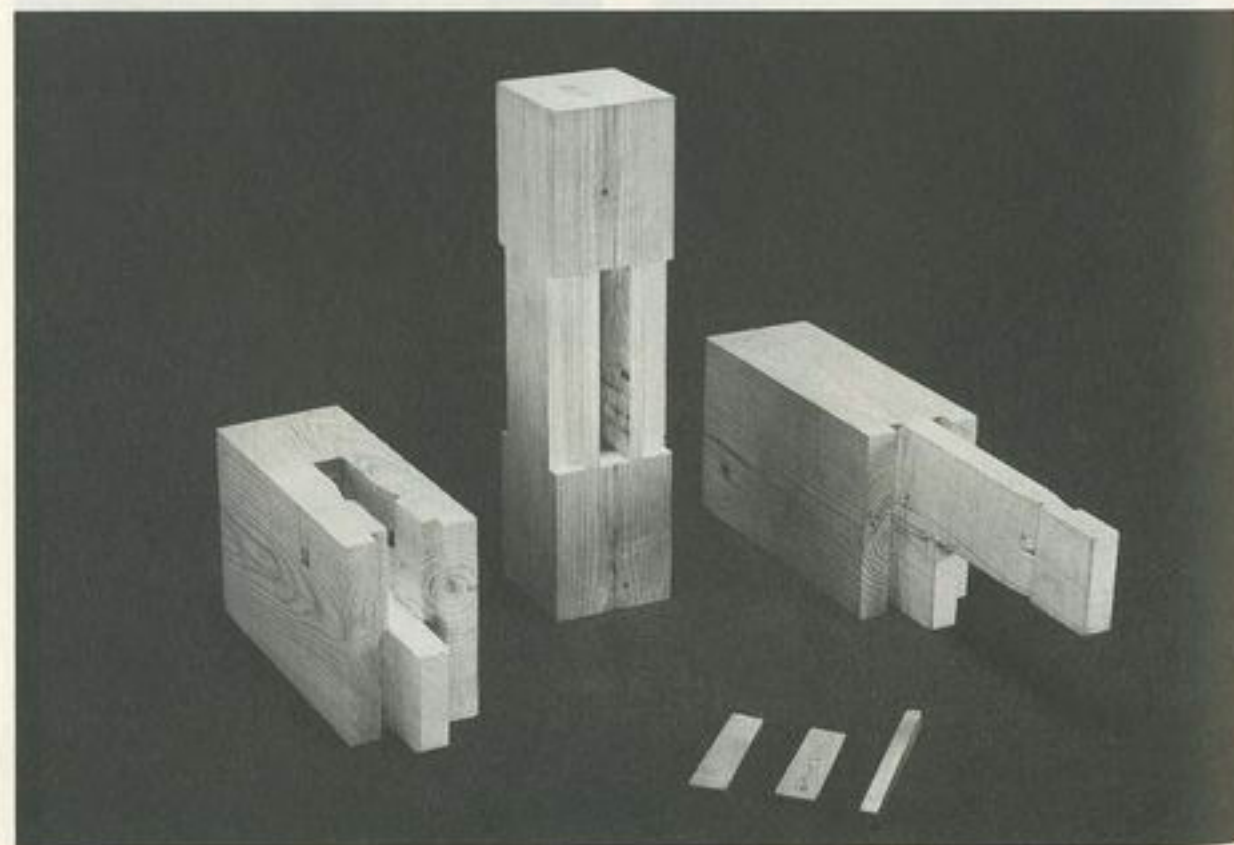

Beam 1 (male)

Column

Beam 2 (female)

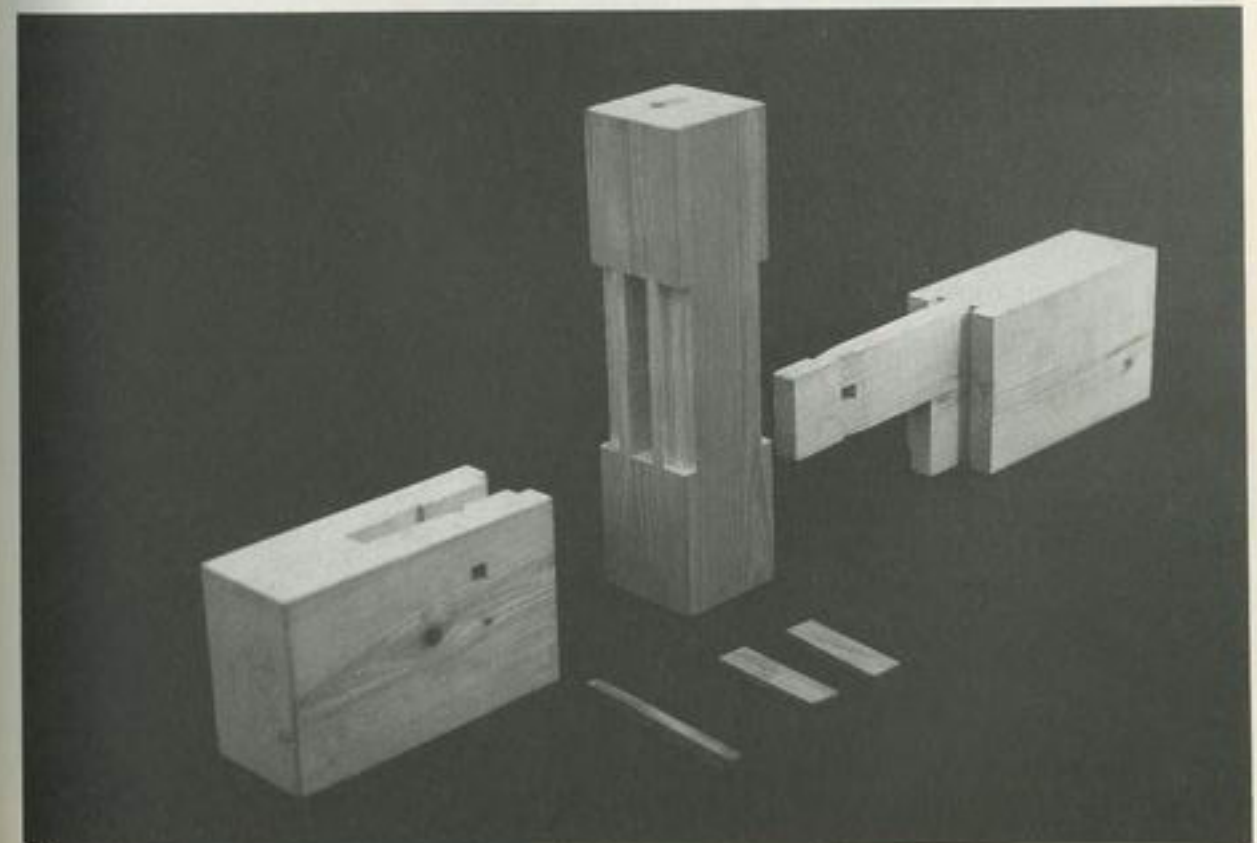

① Arrangement of the members

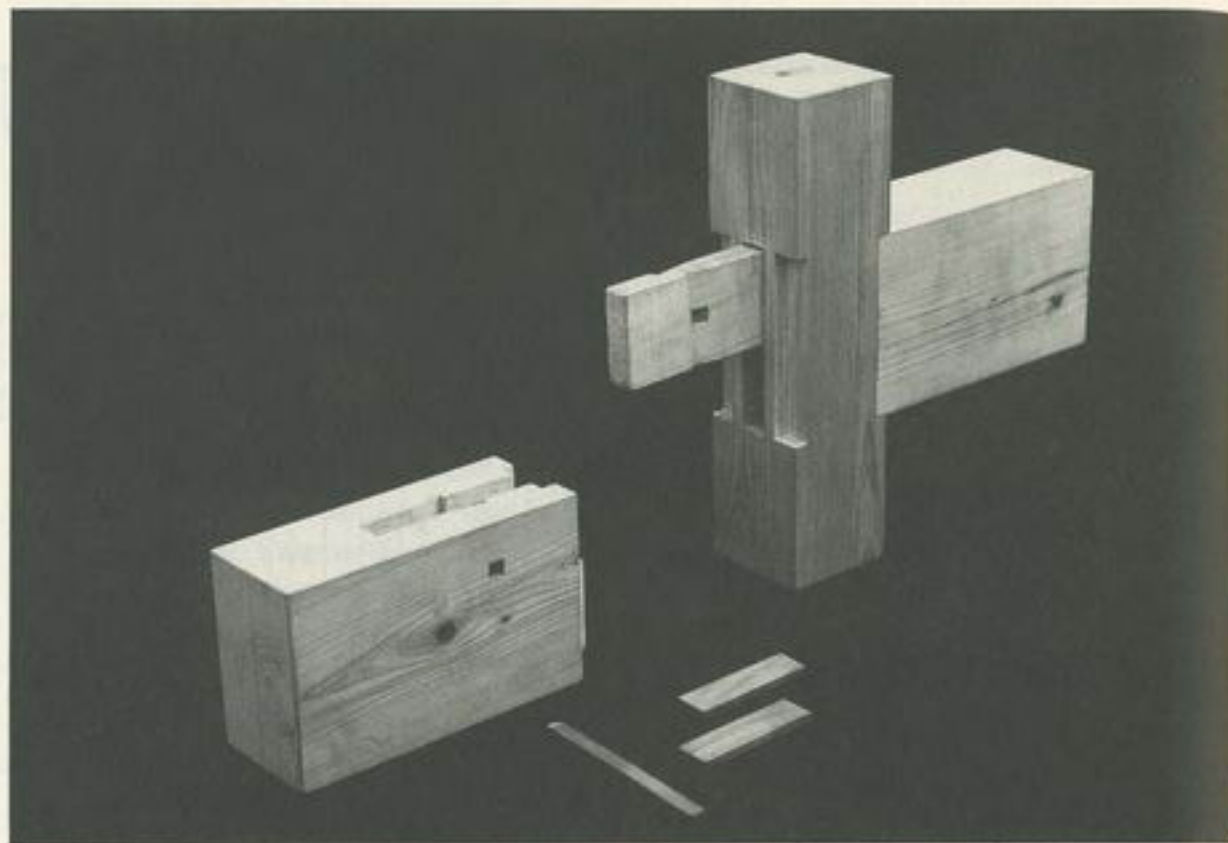

2 Beam 1 is inserted through the column.

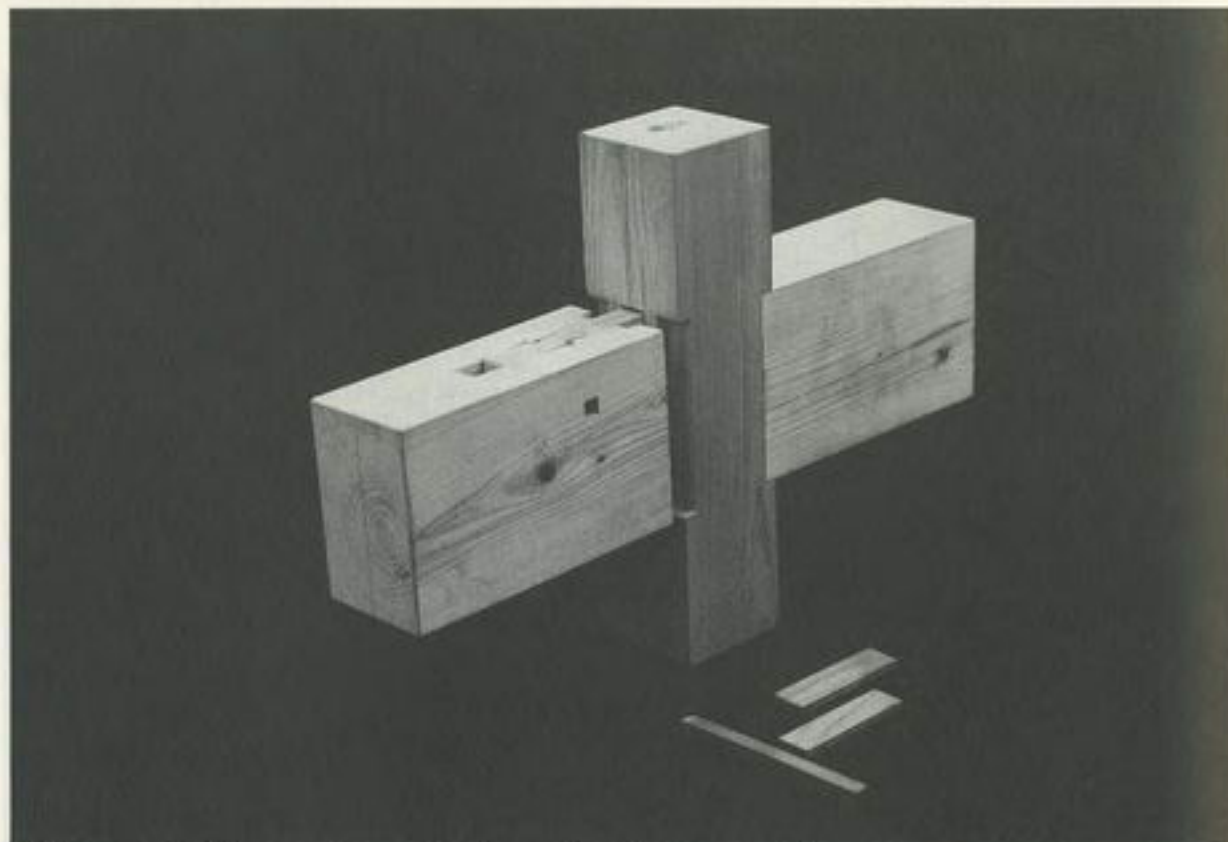

3 Beam 2 slides over the projecting end of the tenon of beam 1.

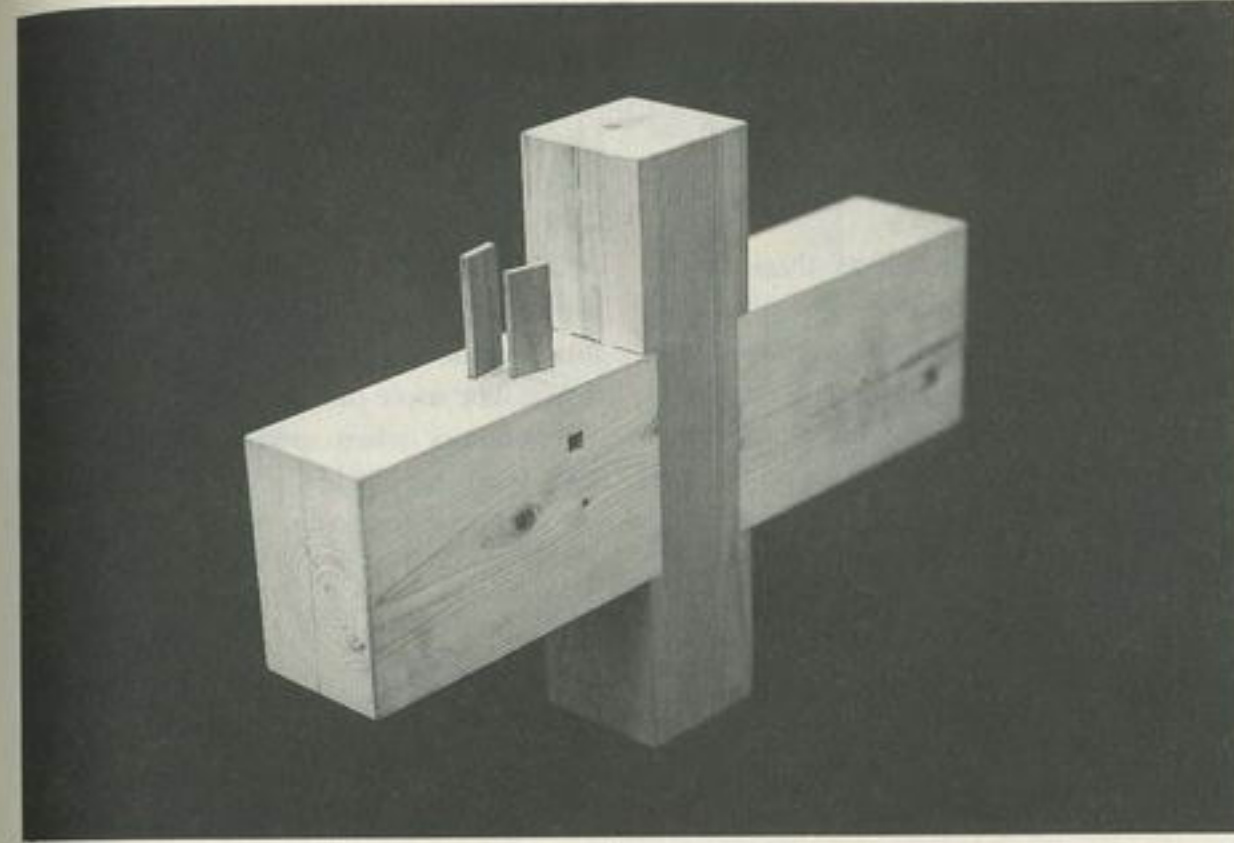

4 After tightening the joint, two keys are inserted.

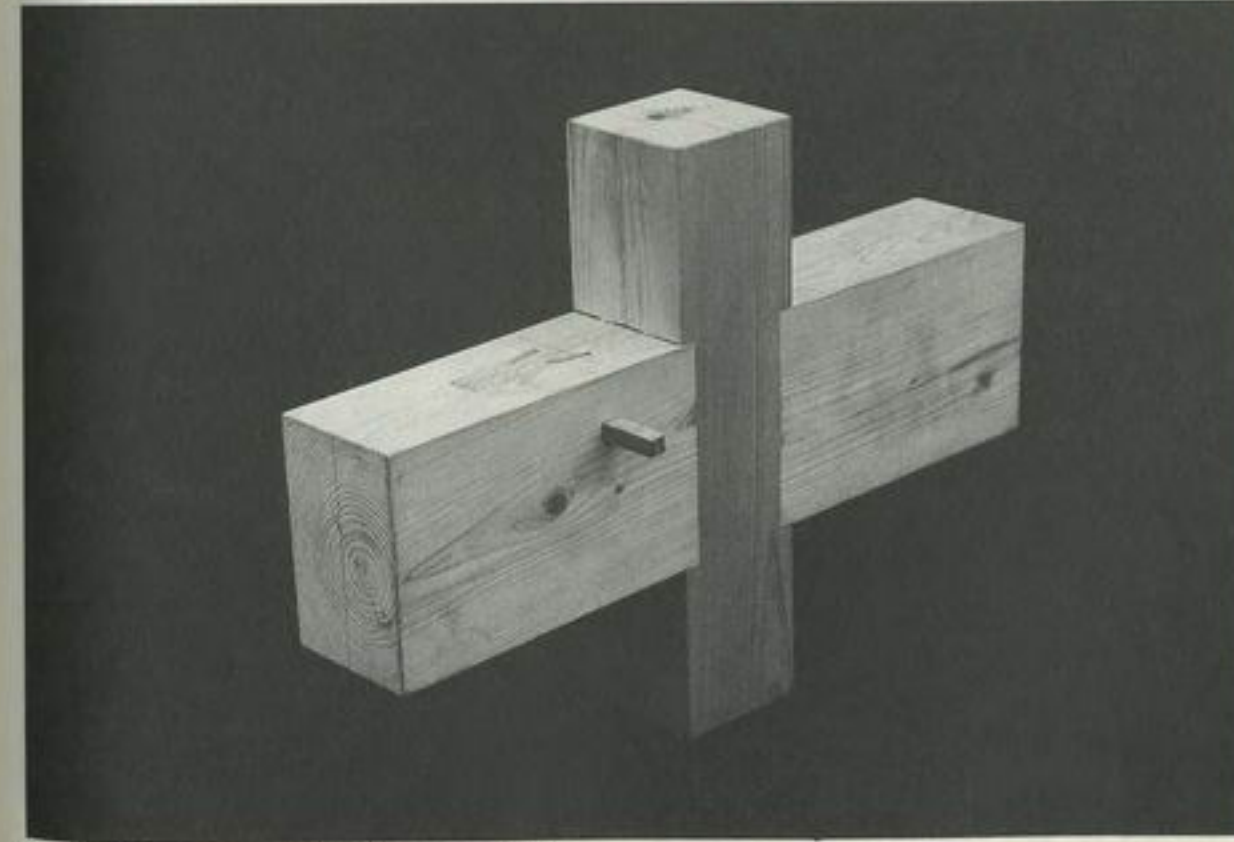

5 A draw pin completes the assembly.

● CONNECTING JOINT 07 ●

Triple plug

This assembly connects three beams on three faces of a column. The two opposite beams are spliced through the column. The first beam to be connected (beam 1, short male) is perpendicular to the other two beams. A dowel secures it to the column. The second part of the assemblage

proceeds in the same fashion as for the preceding joint. The lower part of the tenons of beam 2 (male) and beam 3 (female) is shorter than on the double plug due to the presence of the extra beam. A very tight joint works better. In order to achieve this, the long projecting tenon of beam 2 (male) is made a few millimeters shorter than the dimensions quoted in the figure. The triple plug gives the appearance of continuity when seen from the inside. Seen from the outside, a seam can be seen where the two opposite beams meet.

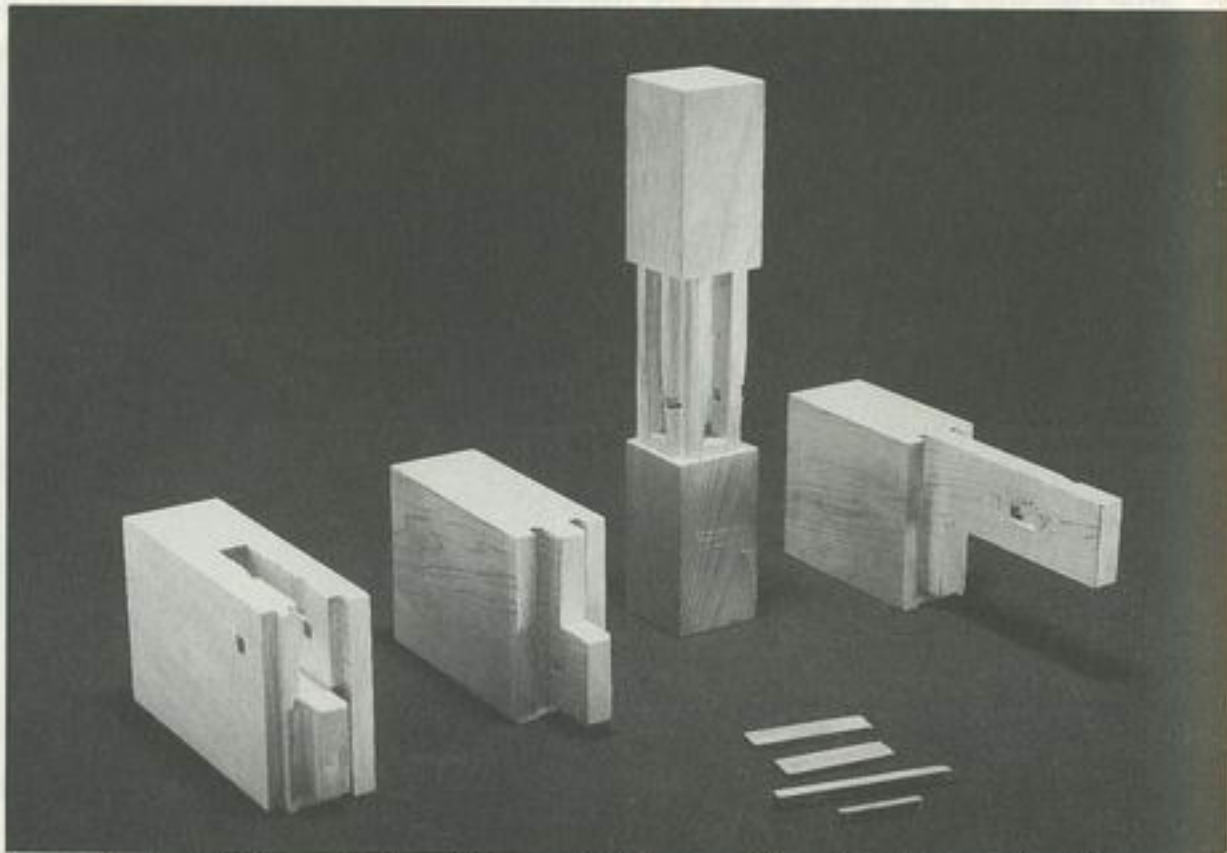

From left to right: beam 1 (female), beam 2 (short male), column, beam 3 (male)
A dowel, draw pin and two keys are at the front.

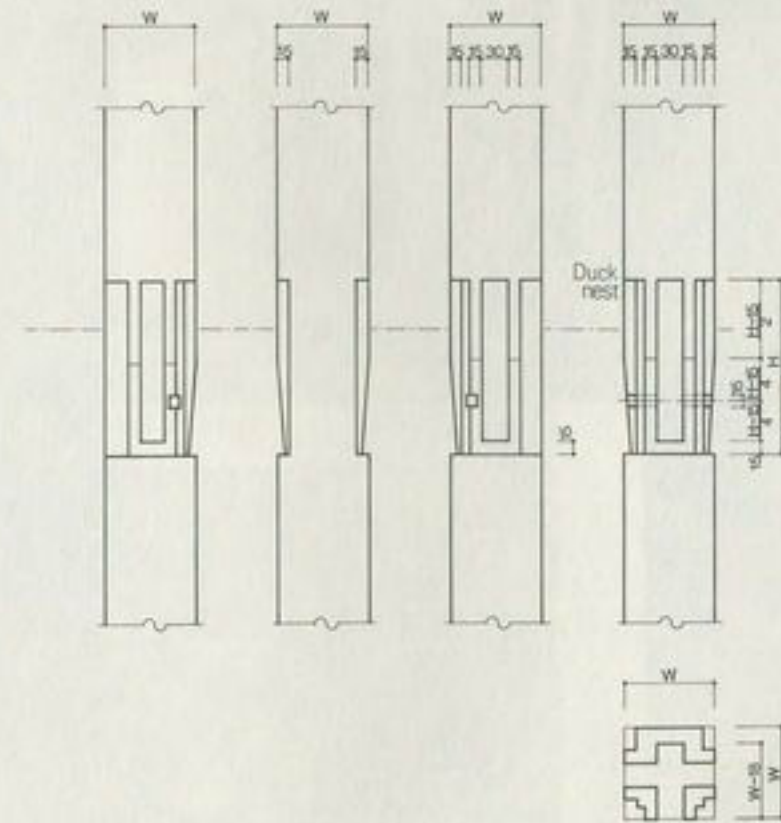
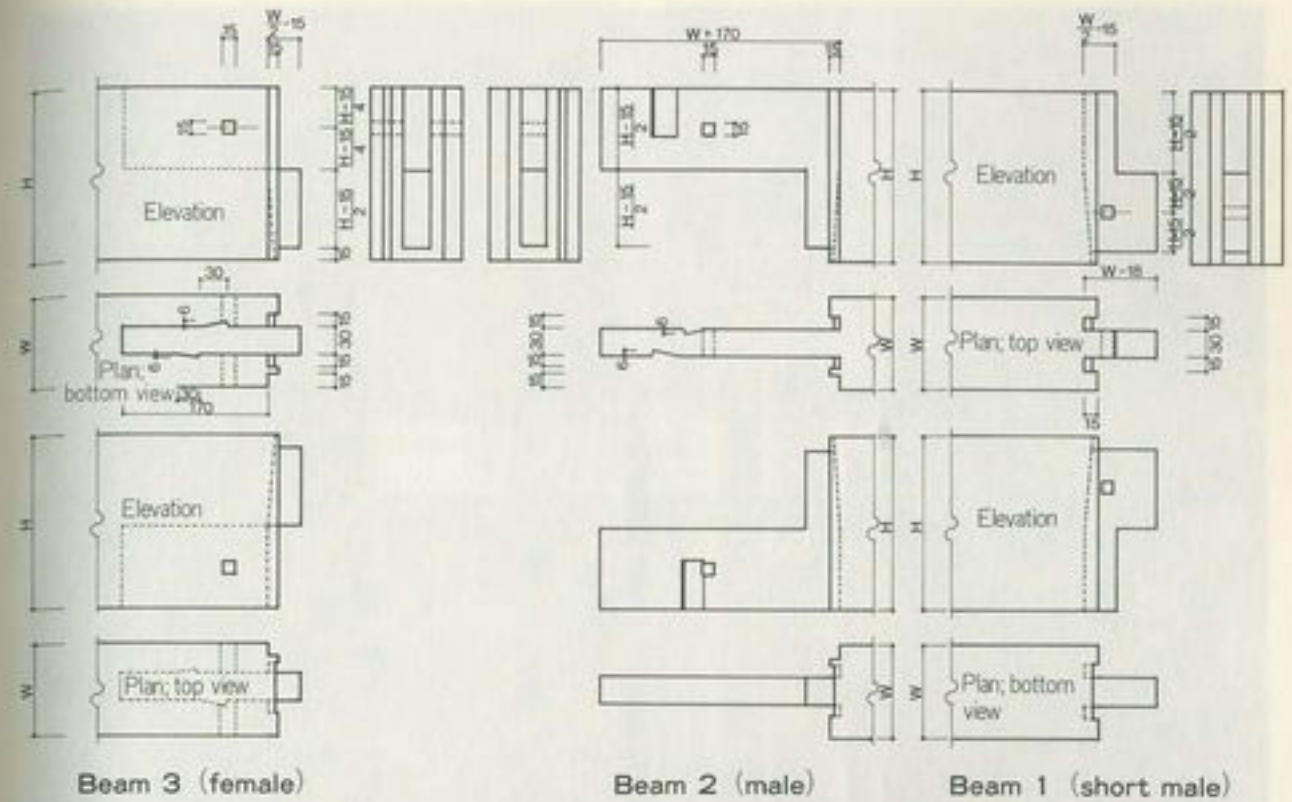

Column

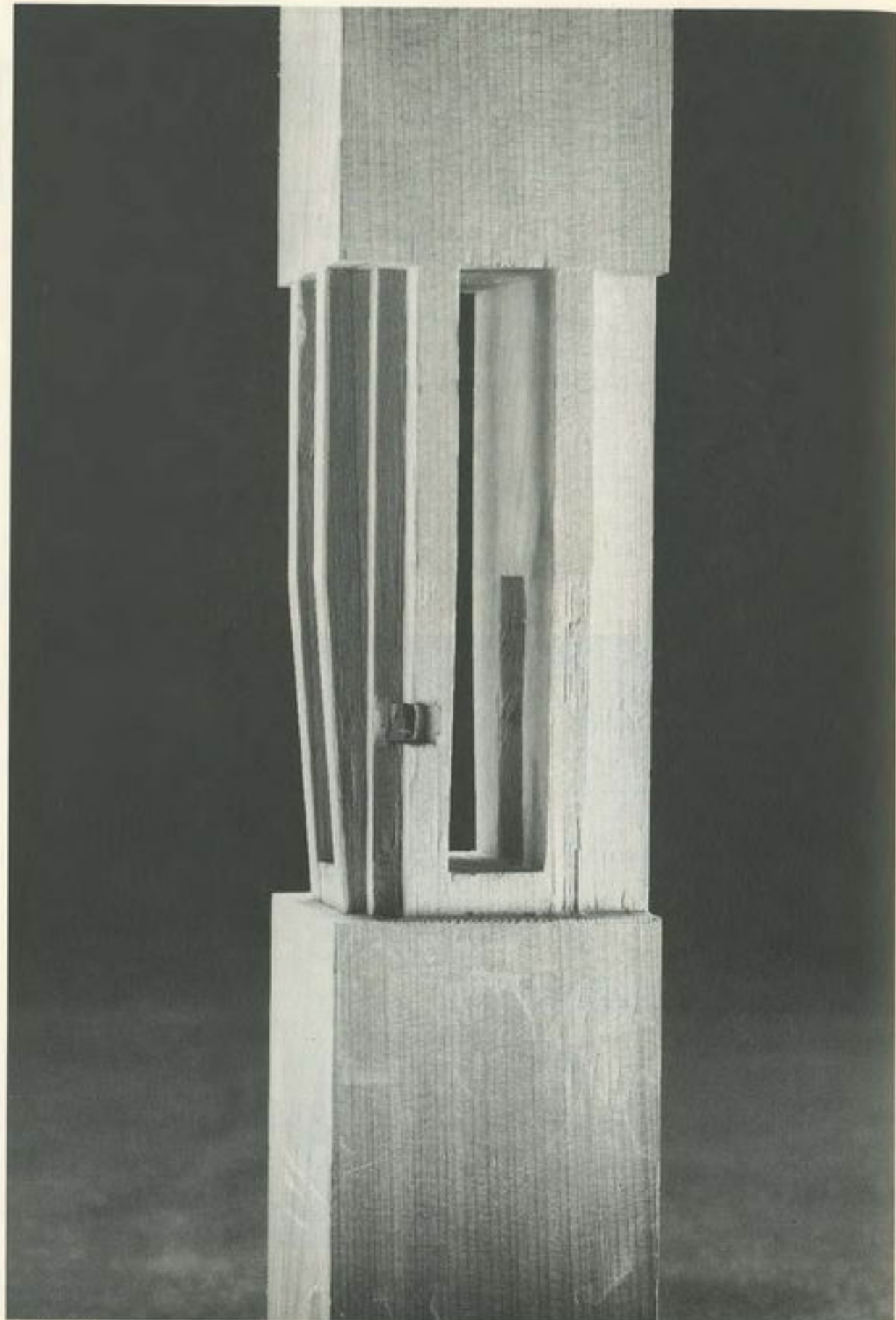

Duck nest

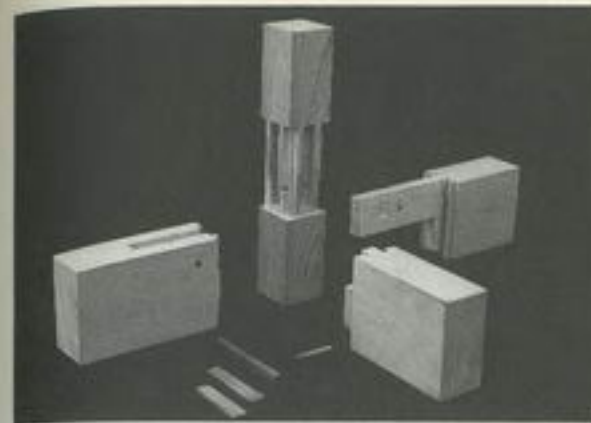

① Arrangement of the members

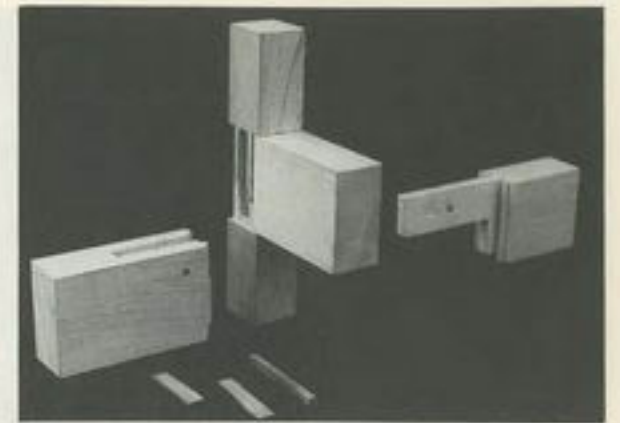

② Beam 1 (short male) is assembled first. The dowel pin is inserted.

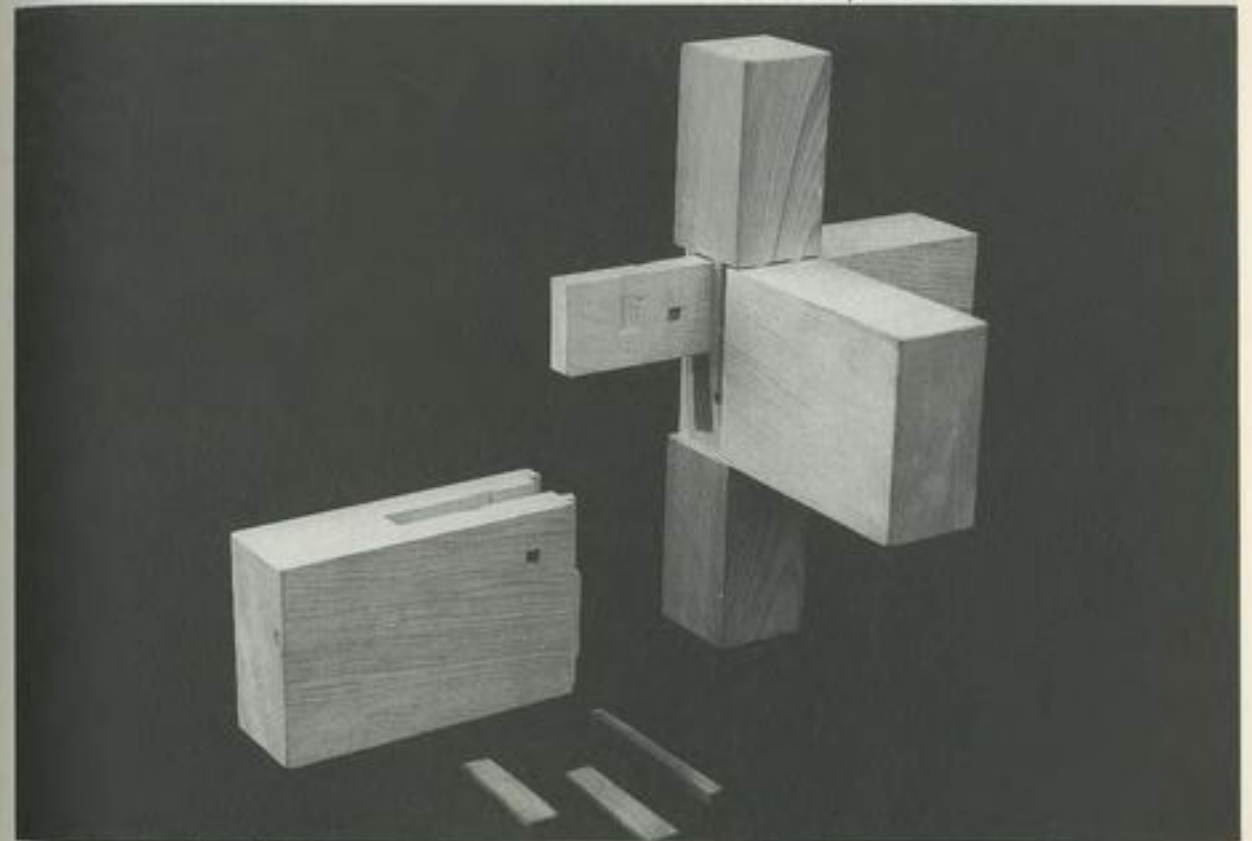

③ Beam 2 (male) is assembled next.



④ Beam 3 (female) slides over the projecting end of the tenon of beam 2 (male).

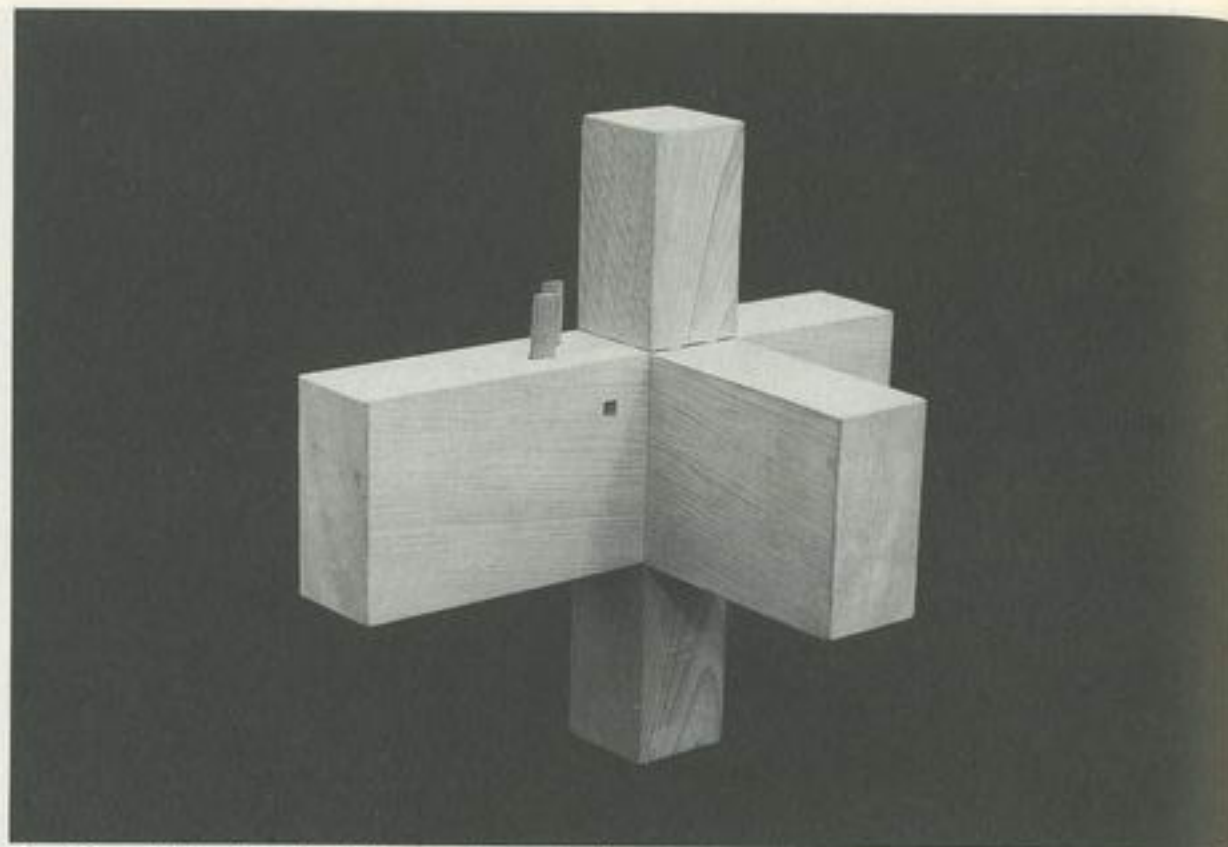

5 After tightening the joint, two keys are inserted.

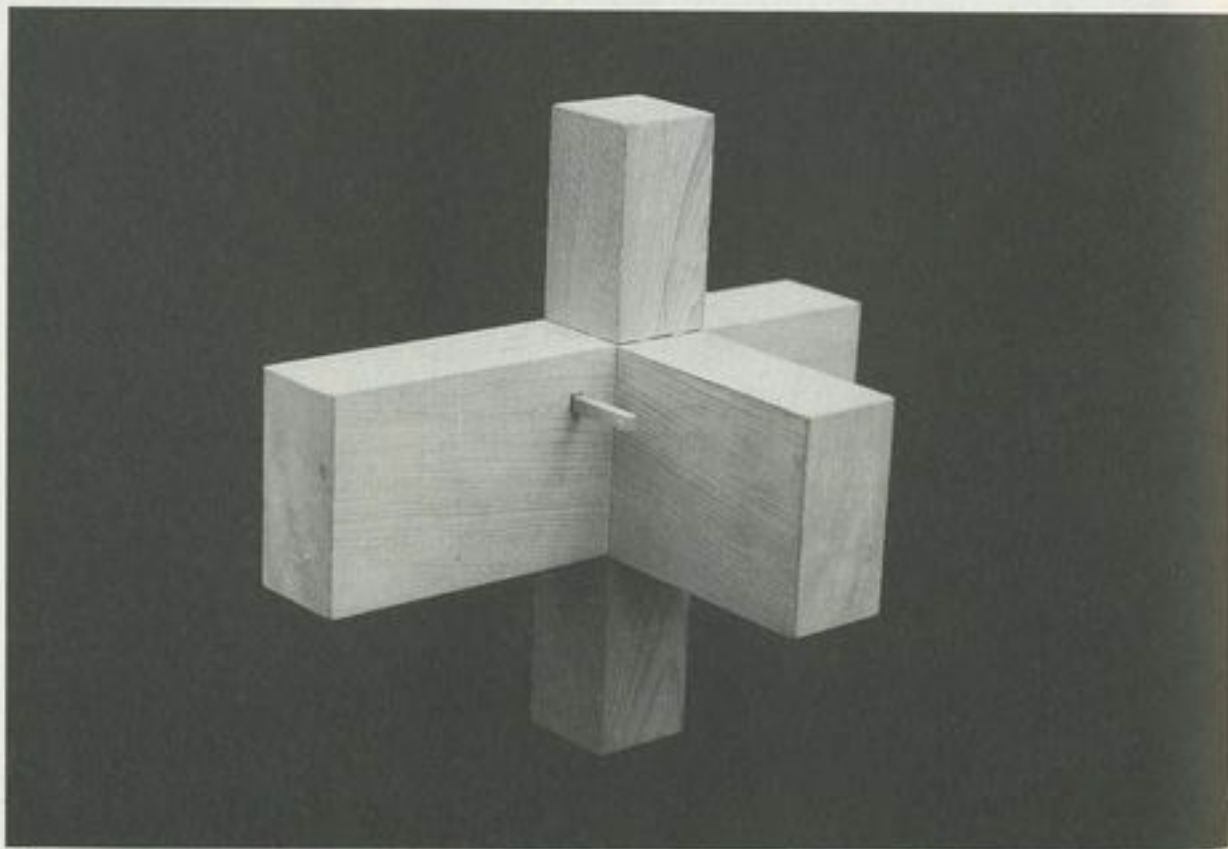

6 A draw pin completes the assembly.

● CONNECTING JOINT 08 ●

Groundsill connectors

(Dodai shiguchi)

(1) Housed dovetail (ari otoshi)

A dovetail is carved on half of the depth of one member. A rectangular mortise runs through the depth of the second member immediately behind the mortise for the dovetail. A column with a simple tenon may complete the assembly. A draw pin secures the column to the groundsill. The length of the pole tenon on the column equals the depth of the groundsill. Thus, even if the groundsill rots, the column will stand firm. This often happens since the groundsill is usually made of softwood and the column made of hardwood.

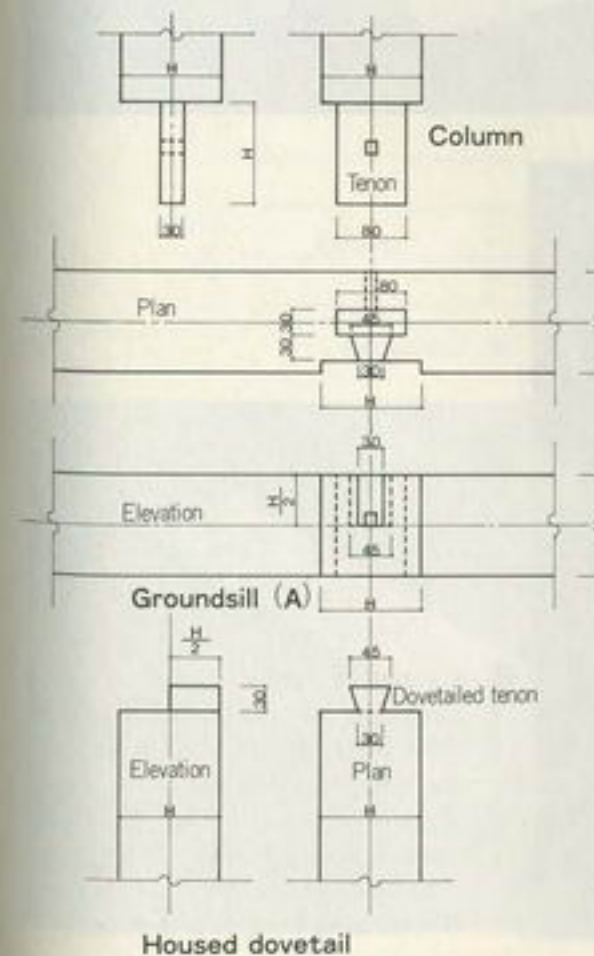

(2) Rabbeted tenon and mortise (kone hozo sashi)

This joint is useful to assemble corner groundsills. The male sill (B) has an eccentric tenon at the end. The female (A) has a mortise cut throughout. After assembly, a wedge is pounded through a slot in the tenon, locking the members together. If there is enough room left at the end of member A (distance $a - H/2$), a column can be connected over the joint using a stub tenon.

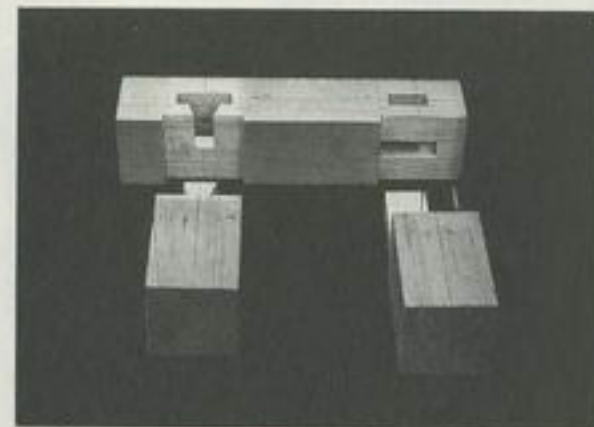

Left side: housed dovetail.

Right side: rabbeted tenon and mortise

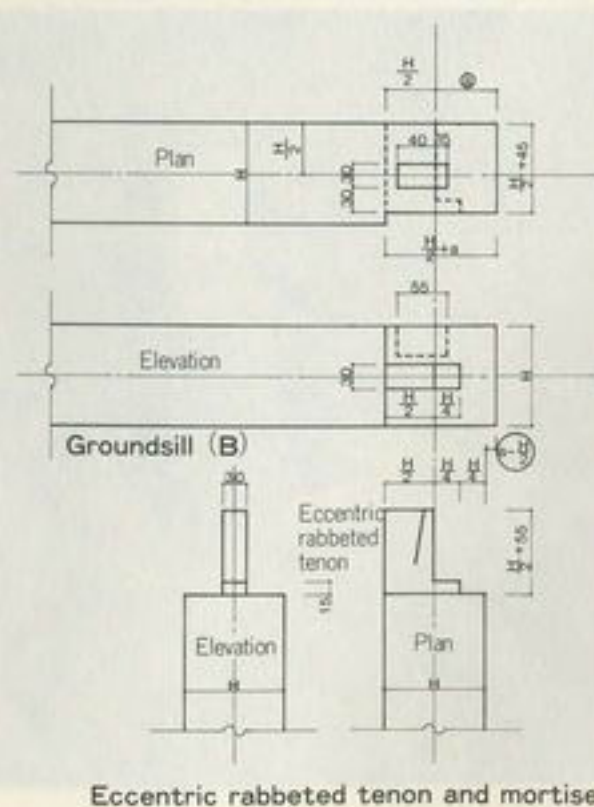

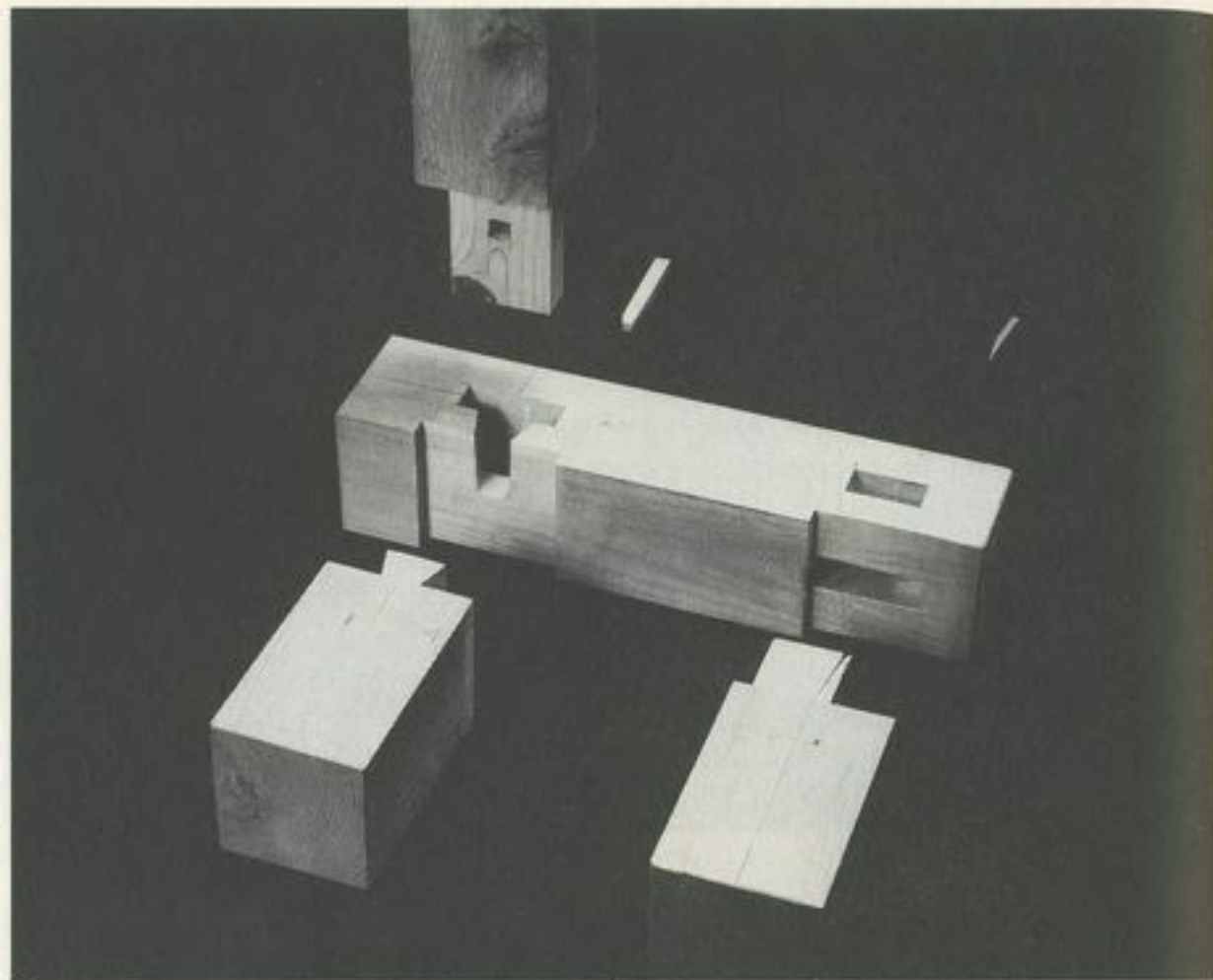

1 Arrangement of the members

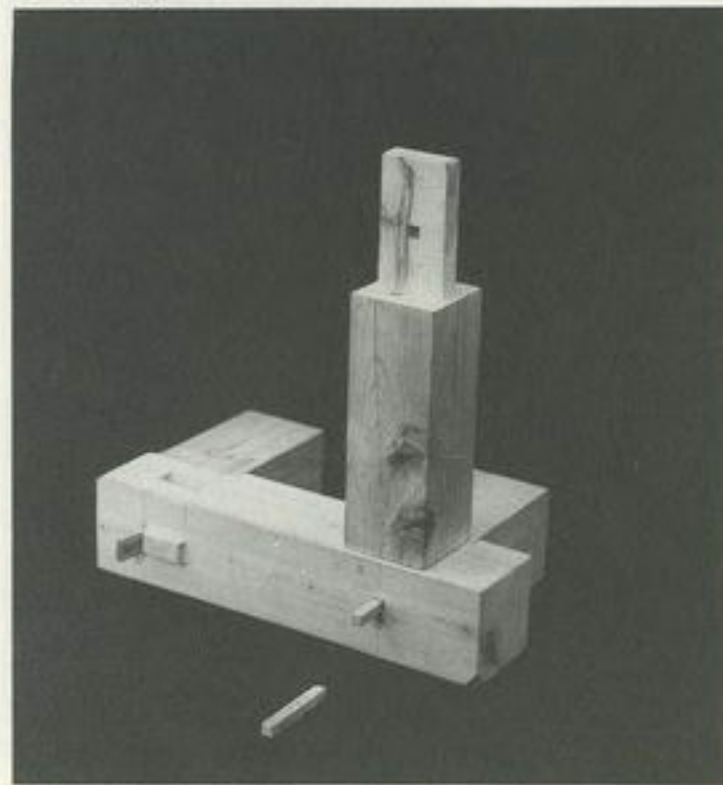

2 Rabbeted tenon and mortise (left): After the male is assembled, a wedge is pounded in, locking the joint (no column shown). Housed dovetail (right); the male slides into the female. The column is assembled and the joint is completed by driving in a draw pin.

(3) Corner miter tenon (sumitome hozo sashi)

This joint also connects corner ground-sills but is more attractive than the previous one. A tongue and groove on the inside ensure rigidity while a panel on the outside gives the joint a cleaner look. The outside seam is located at the corner making the

assembly appear to have been made out of a single piece of wood. The tapered panel at the end of member B (male) reduces the distance (a) left at the end of member A (female). For this reason, a trapezoidal stub tenon is preferred to connect a column over the corner joint.

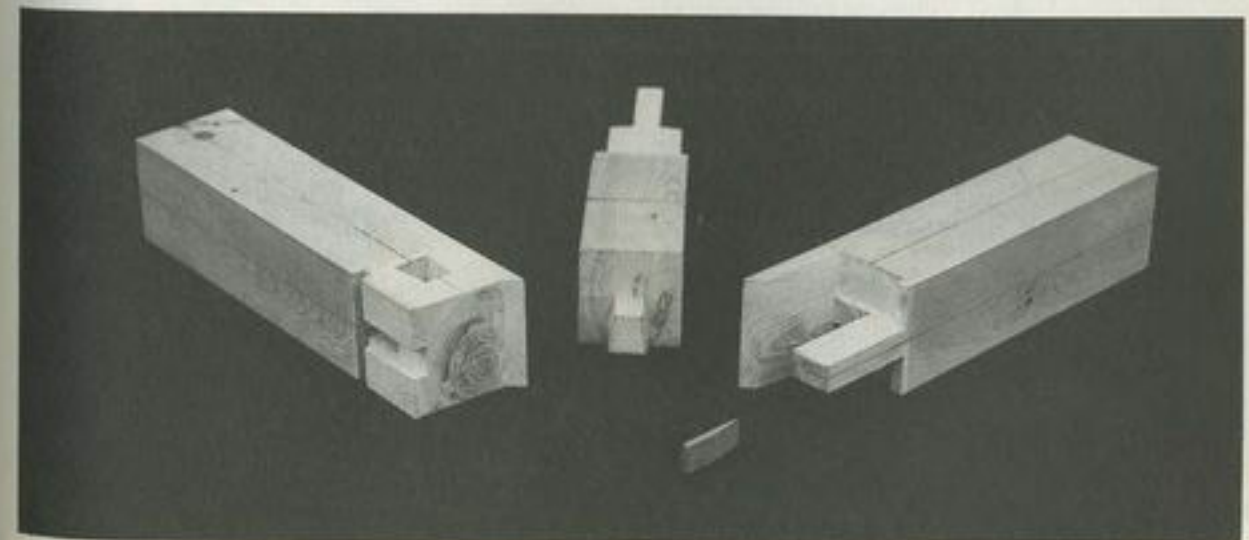
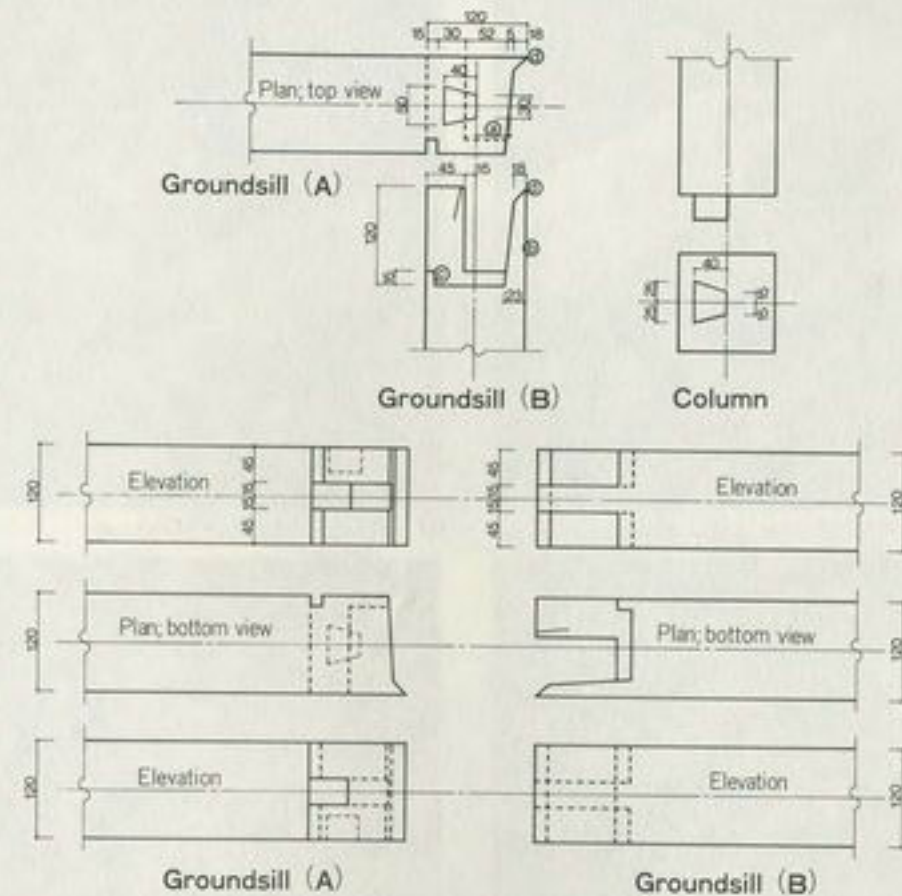

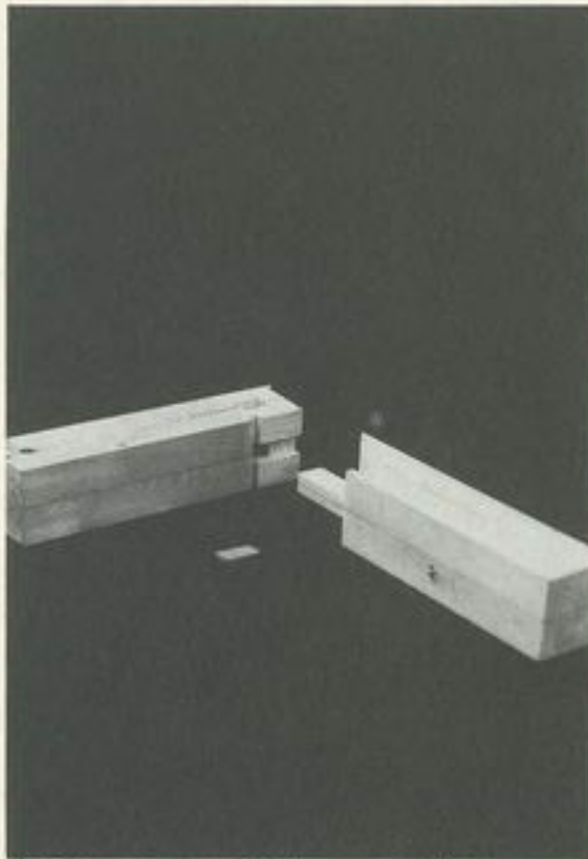

① Arrangement of the groundsills

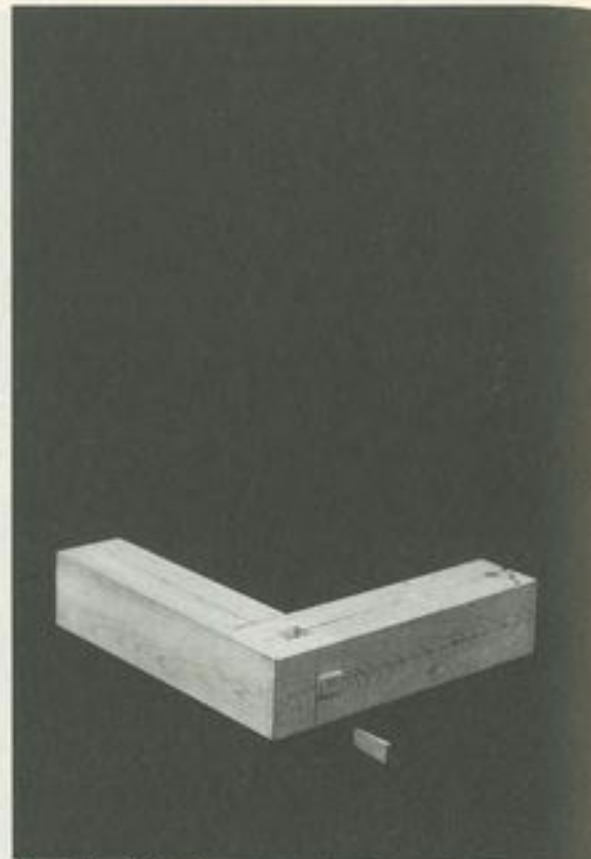

② The joint is assembled.

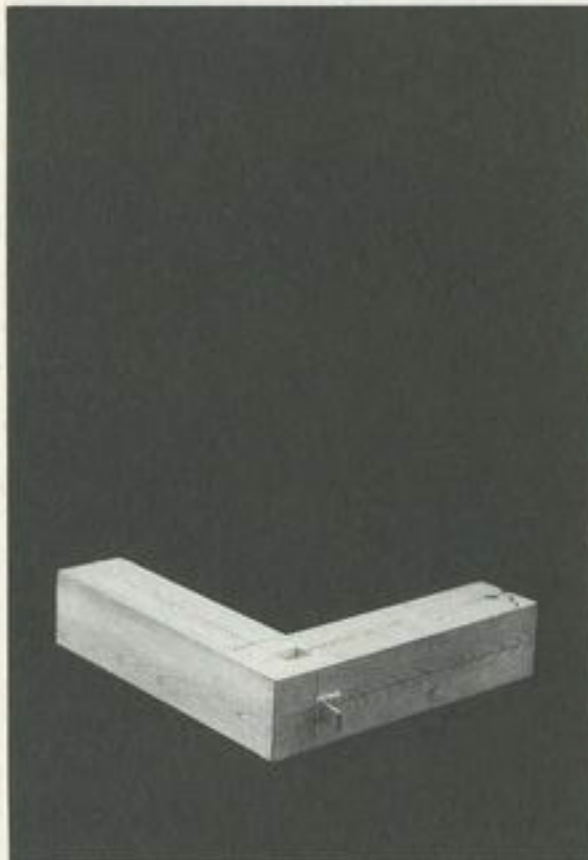

③ A wedge is pounded in.



④ A column is set on top of the sill.

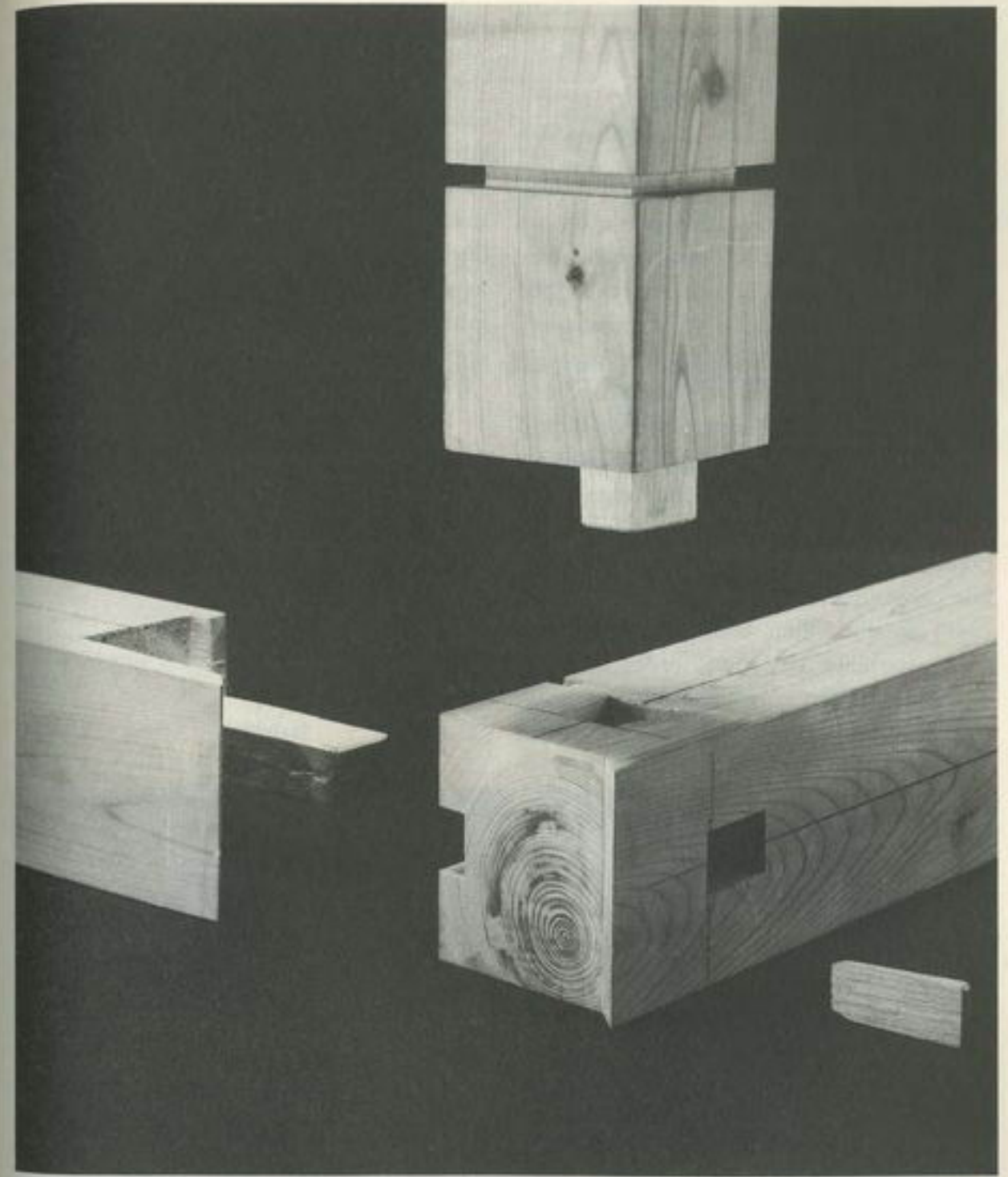

● CONNECTING JOINT 09 ●

"Kyoro" system

This roofing system joins very specialized elements. The eave girders run on top of the columns on the outer walls. The rafters are connected to tie beams called the rainbow beams. The rainbow beams are supported by the eave girders. The supporting point of the rainbow beams is determined with a tool called the rainbow board (hikari ita). The basis for the roof support system lies on the saddle point (toge). The saddle point is at the intersection of the bottom edge of the rafters and of a vertical line perpendicular to the center line of the eave girders. Often this point is located above the eave girder in order to avoid weakening of the same. The rainbow beam has a dovetail shape at the end which

connects onto the eave girder. A groove as wide as the rainbow beam is also cut into the eave girder to give full support to the rainbow beam. This system has to be made strong enough to support the roofing load and also roofers, who frequently hang onto the tie beams during erection or use them to lift loads. The full width groove protects against splitting of the tie beams. Another groove is sometimes cut through the top of the rainbow beam to receive the rafters.

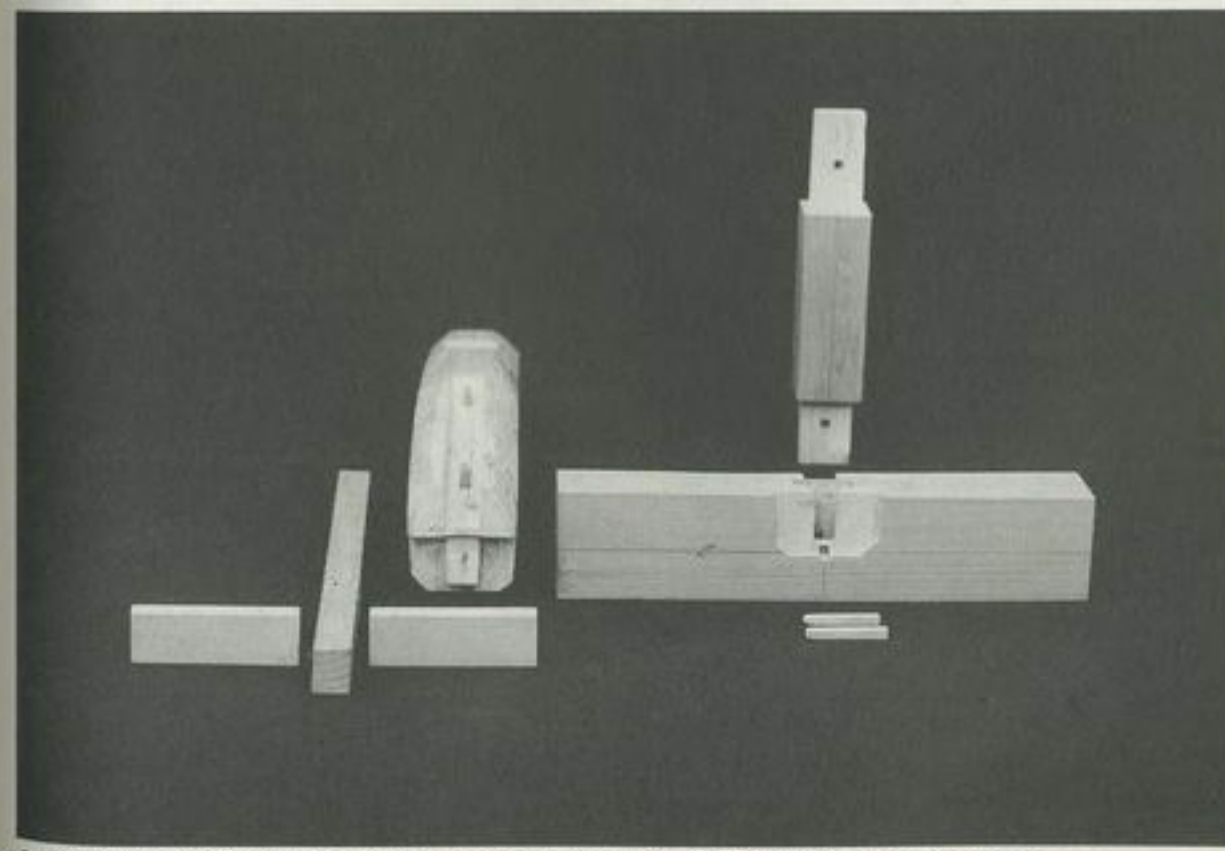
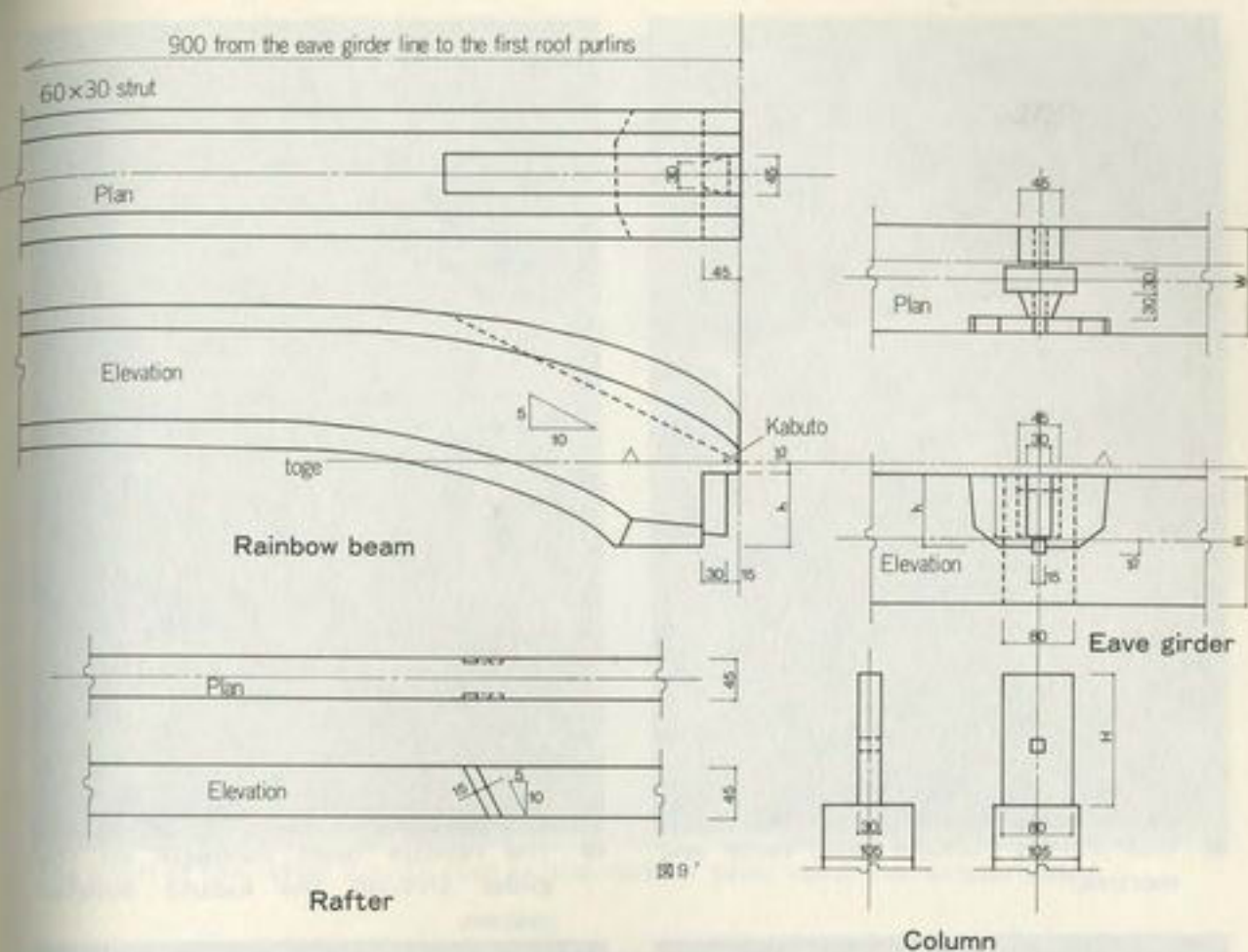
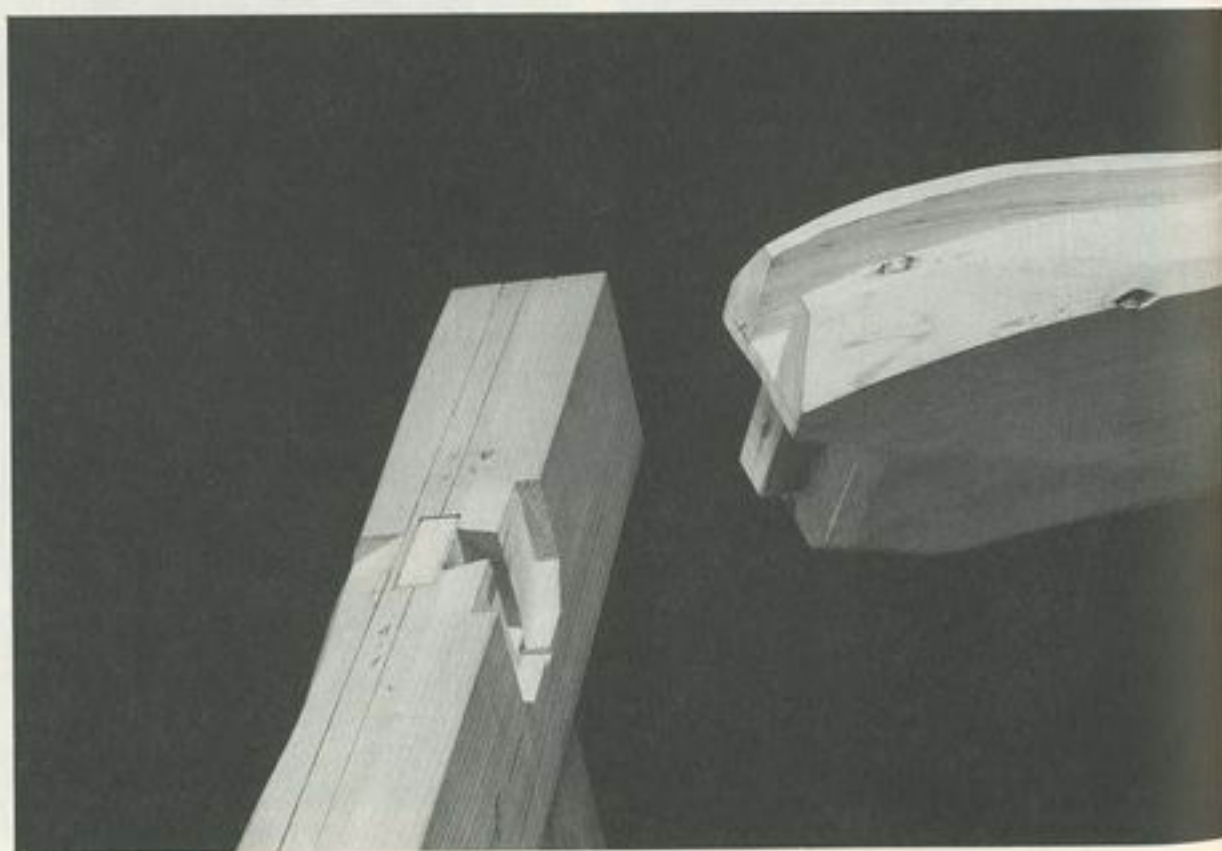
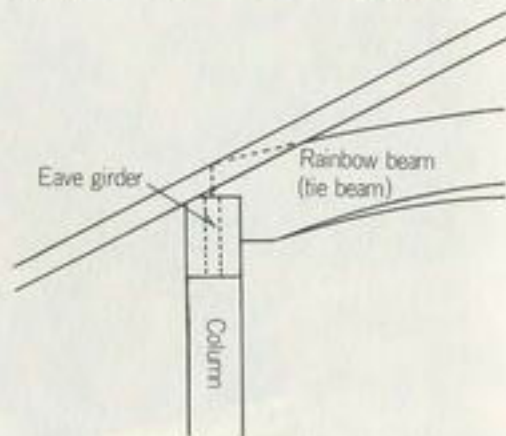

Covering board (mentoban) and rafter; rainbow beam, column and eave girder

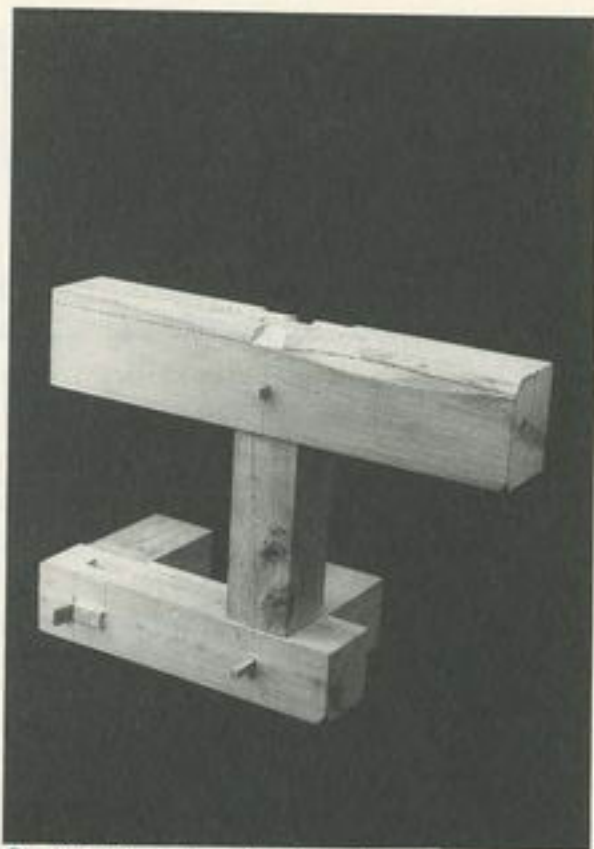

① Wall framing (column head: tenon and mortise)



② The rainbow beam connects on the girder through the kabuto dovetail system.

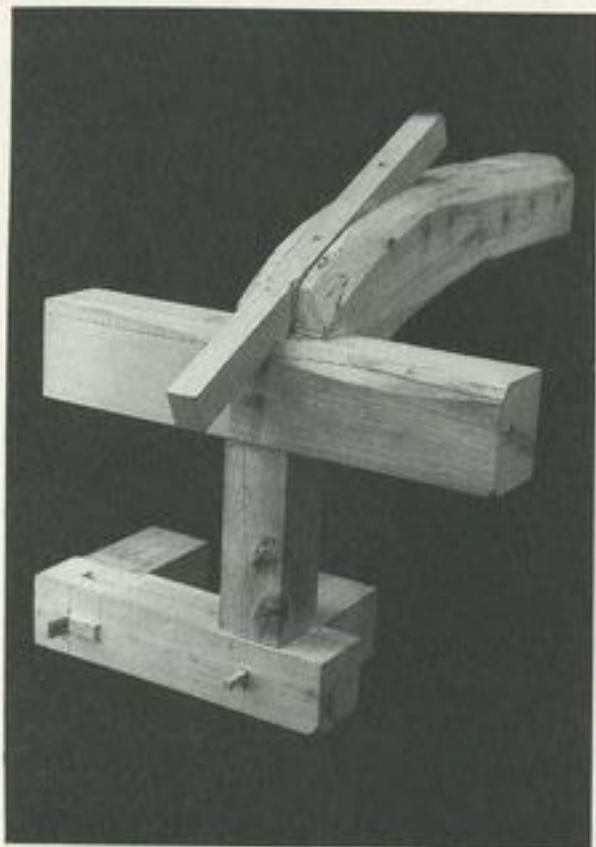

③ A rafter is installed on the top of the rainbow beam.

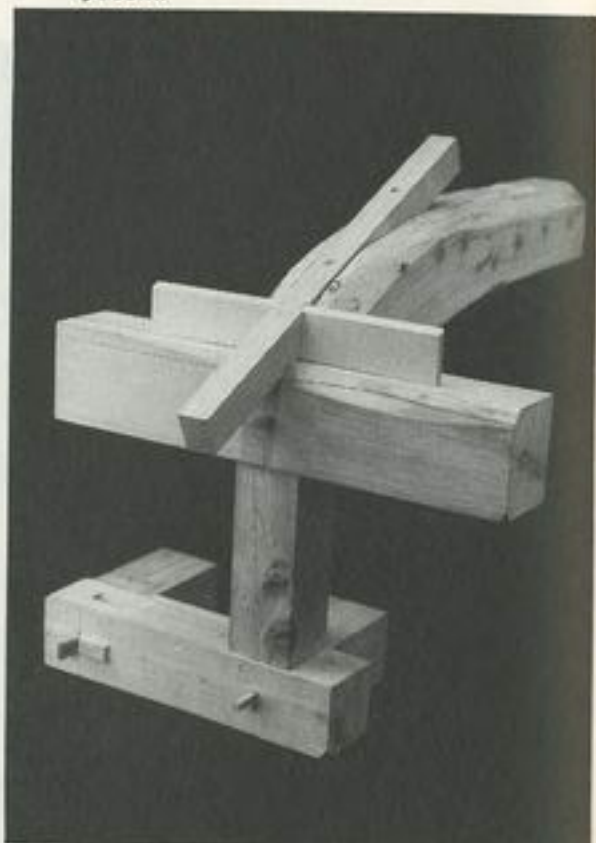

④ A covering board completes the kyoro system.

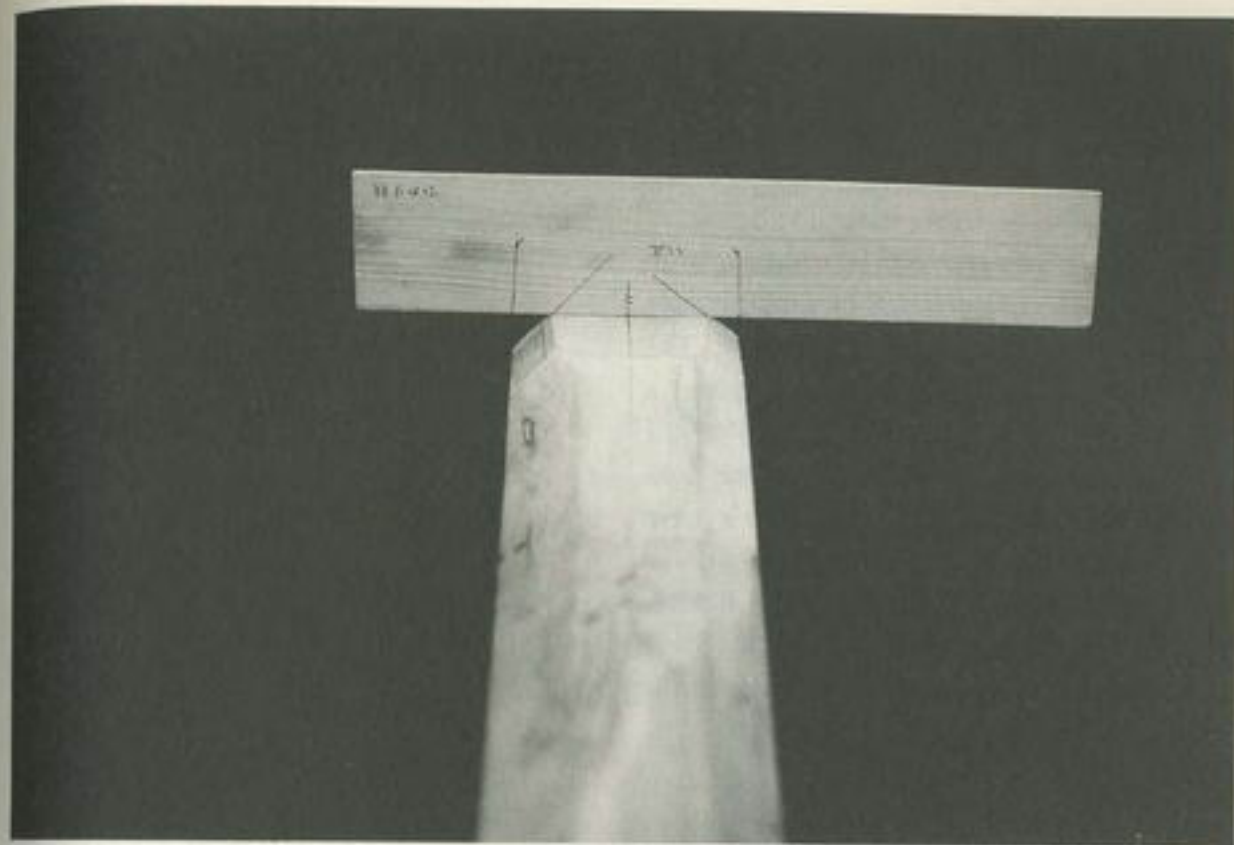

The pitch of the rafter is projected on the rainbow beam using the rainbow board.

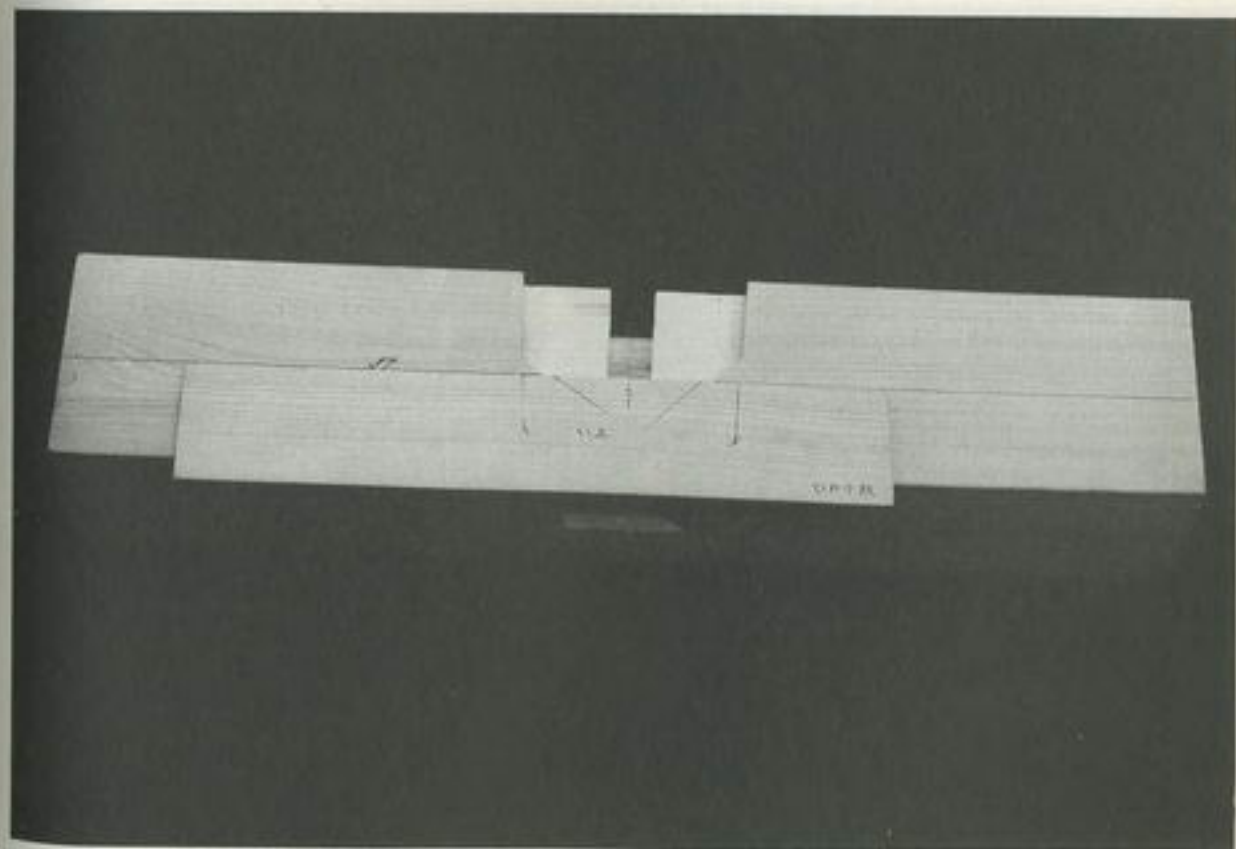

The connecting point between tie beam and girder is spotted using the rainbow board.

● CONNECTING JOINT 10 ●

“Orioku” system

In this case, the rafters' tie beams sit directly on top of the columns and the eave girders run on top of the tie beams. The stepped tenon of the column is notched a few millimeters shorter than shown in the diagrams to avoid having the girder accidentally snagged by it. The Orioku system results in a lower ceiling height than the Kyoro. The Kyoro system is more flexible because rafters and tie beams do not have to be supported at the same location as the columns.

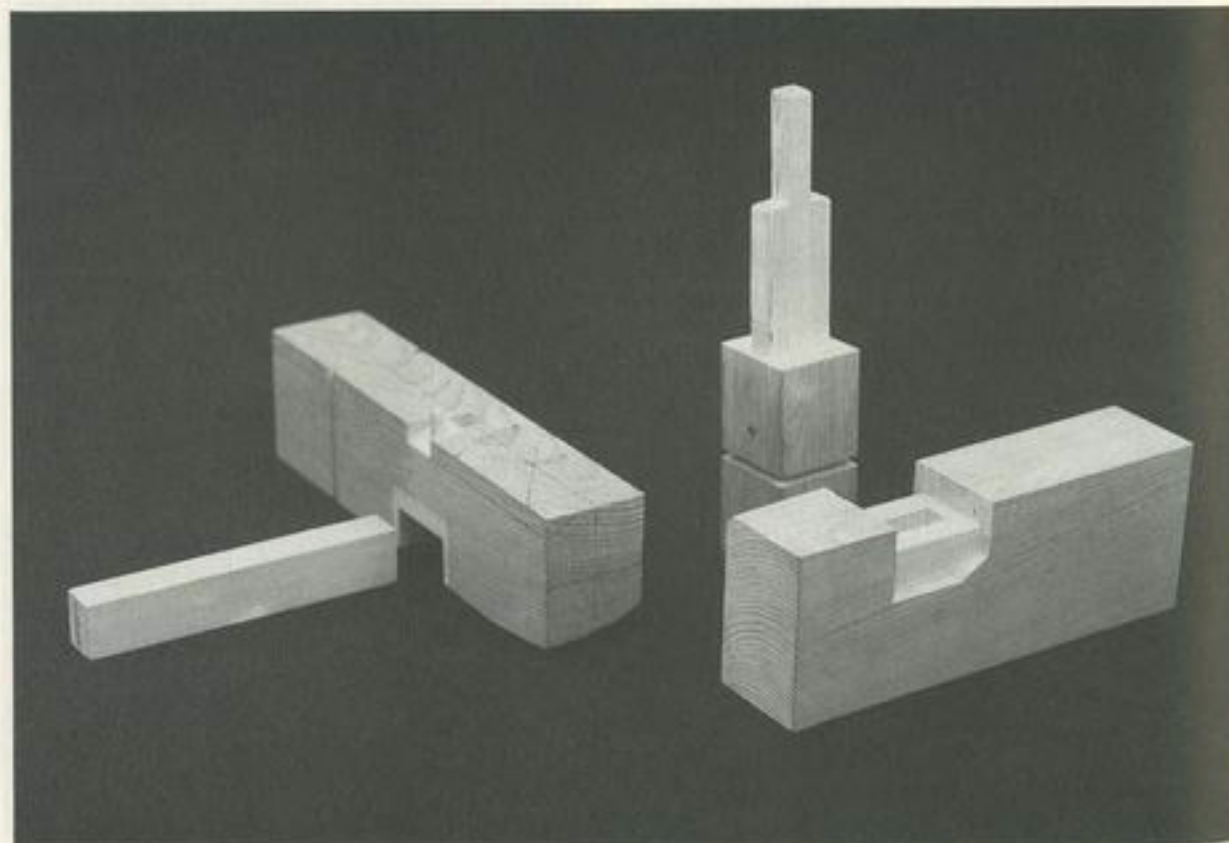
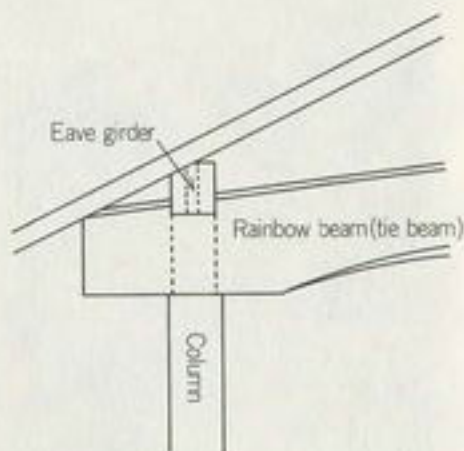

From left to right: rafter, girder, column, tie beam

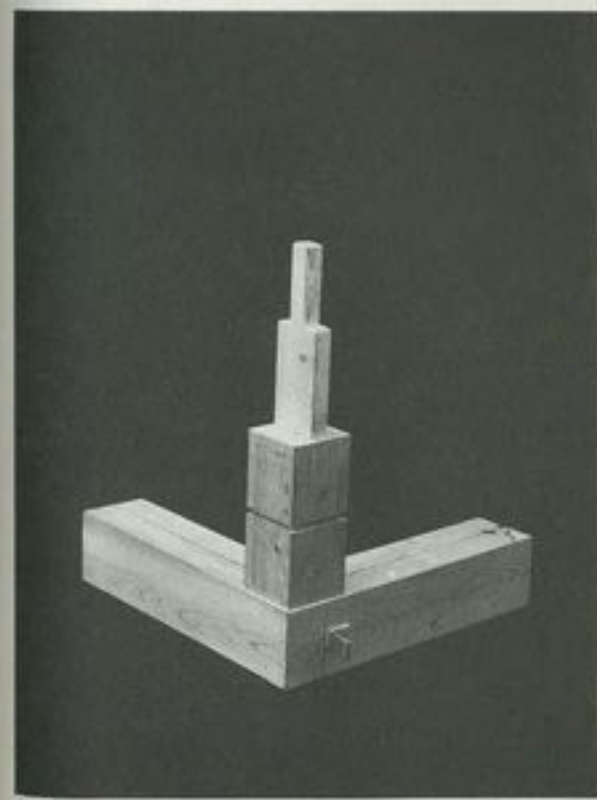
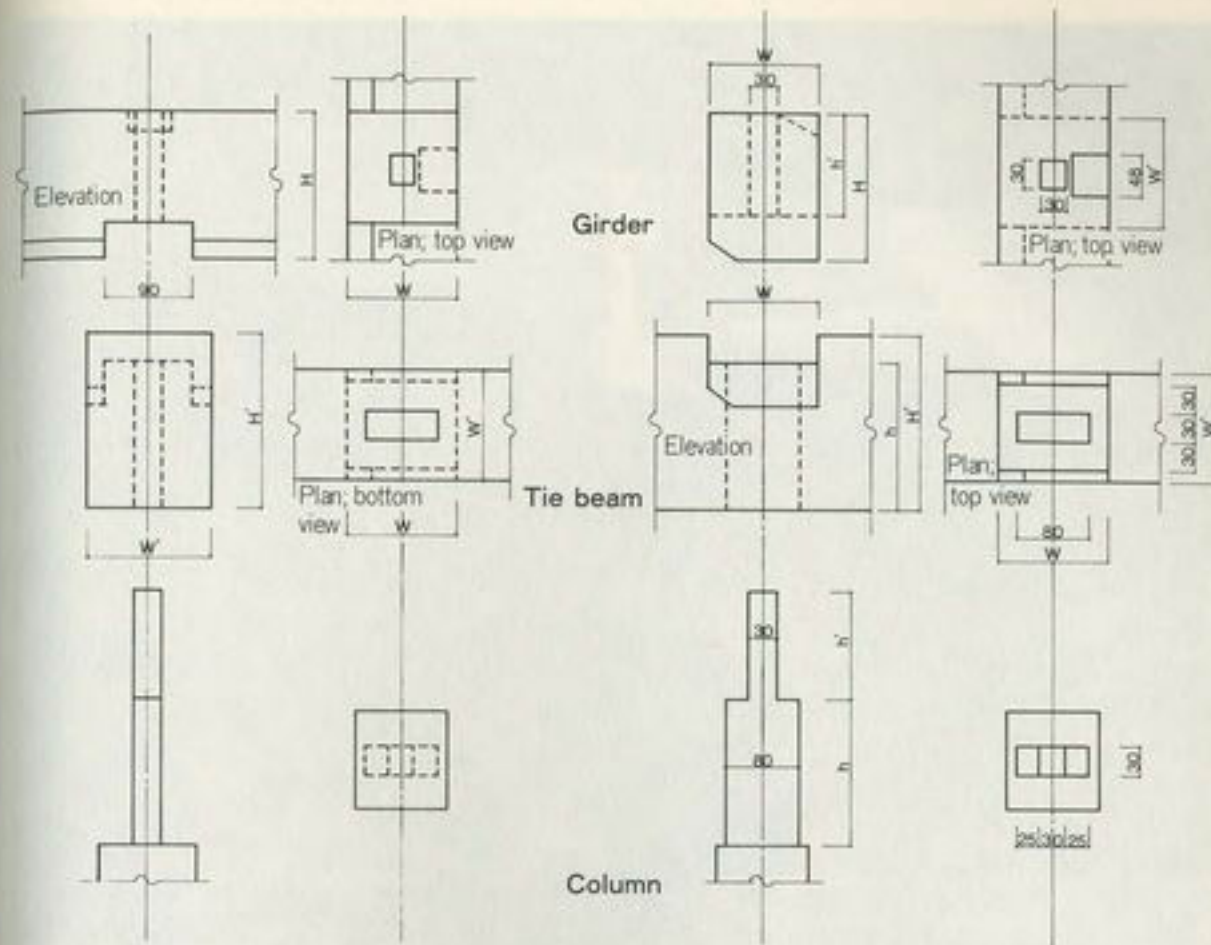

1 The column is set on a ground sill.

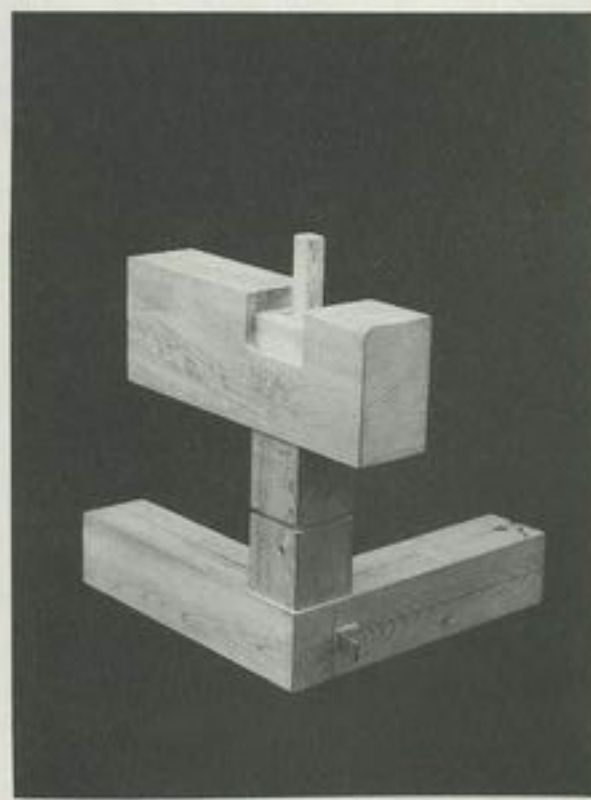

2 The tie beam is set onto the column (column head: stepped tenon).

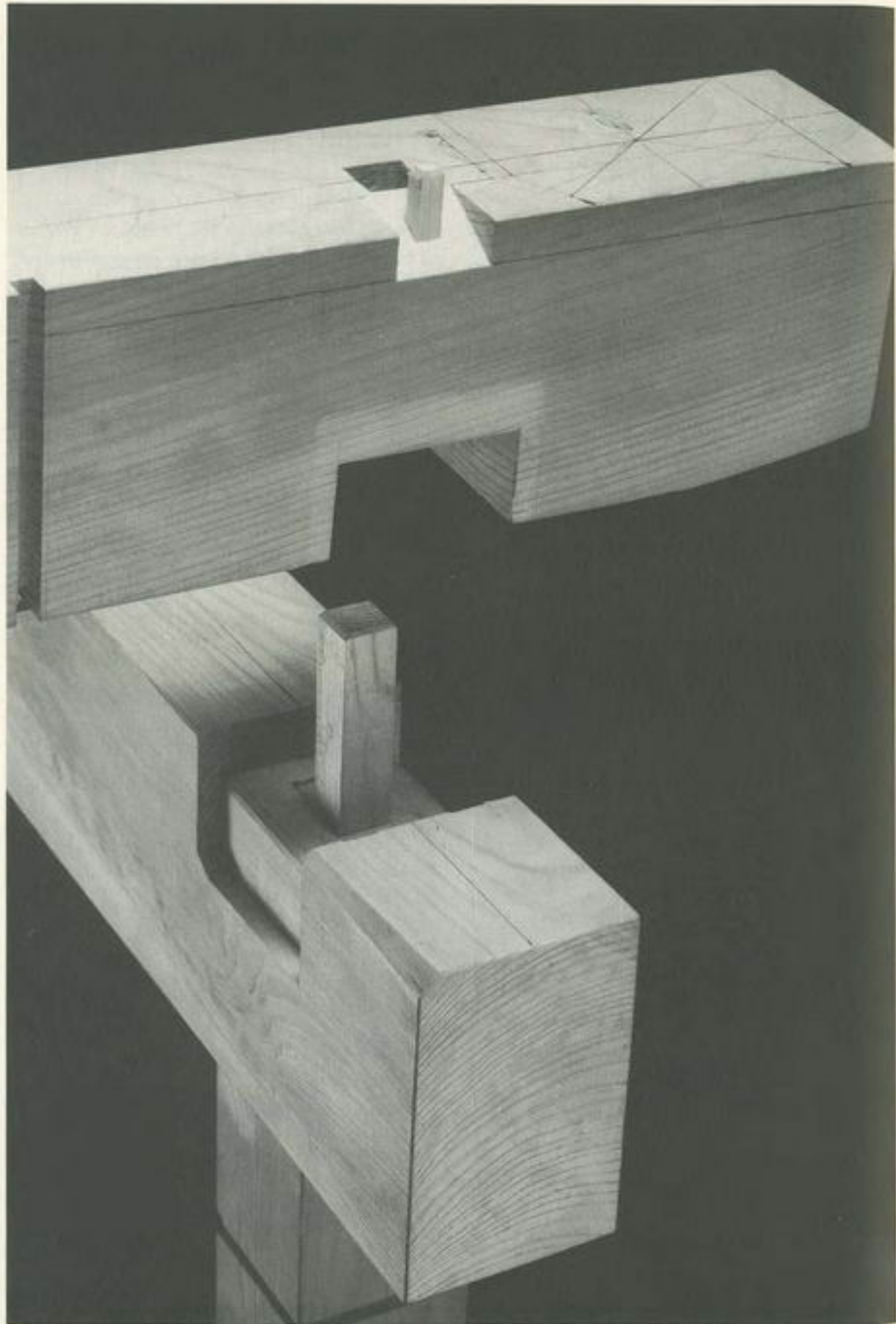

3 The girder connects onto the tie beam with a cogged joint.



4 Same as before

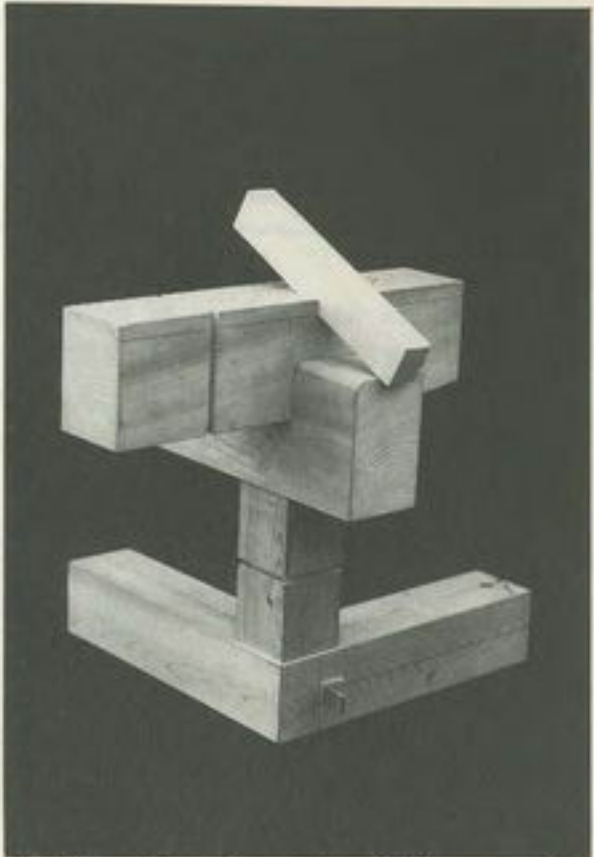

5 The rafter sits on top of the eave girder.



6 Same as above

● CONNECTING JOINT 11 ●

Tie beam connector

(Koya daimochi)

Sometimes tie beams must be spliced and tied to an internal roof beam network. The unique characteristic of this joint is that neither the lower tie beam nor the

upper tie beam suffer a reduction in section at their splicing point. The diagram displays the arrangement of such a joint with provision for a purlin post on top of the assembly. Generally purlin posts are evenly distributed. They are not always located at the connection of tie beams and roof beams. The dowels used to position the tie beams over each other are usually 30mm wide and are always drilled in vertically instead of normal to the internal faces of the joint.

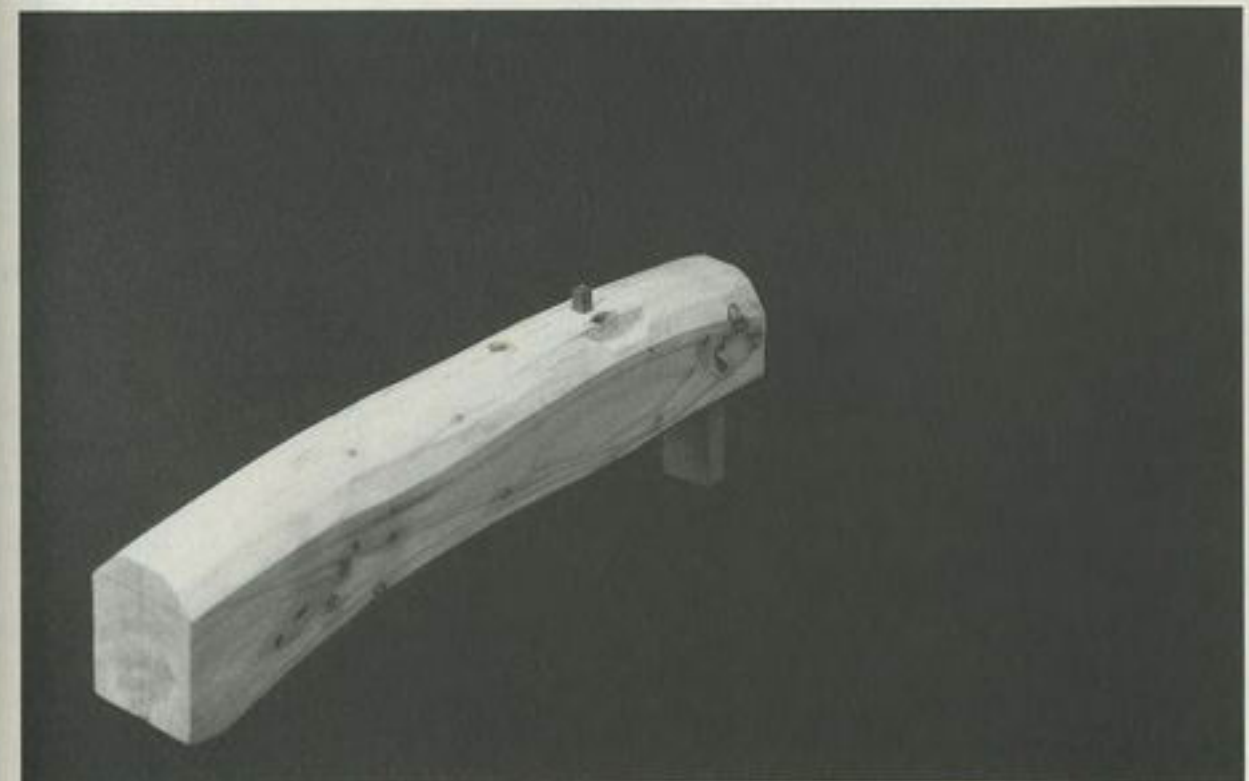
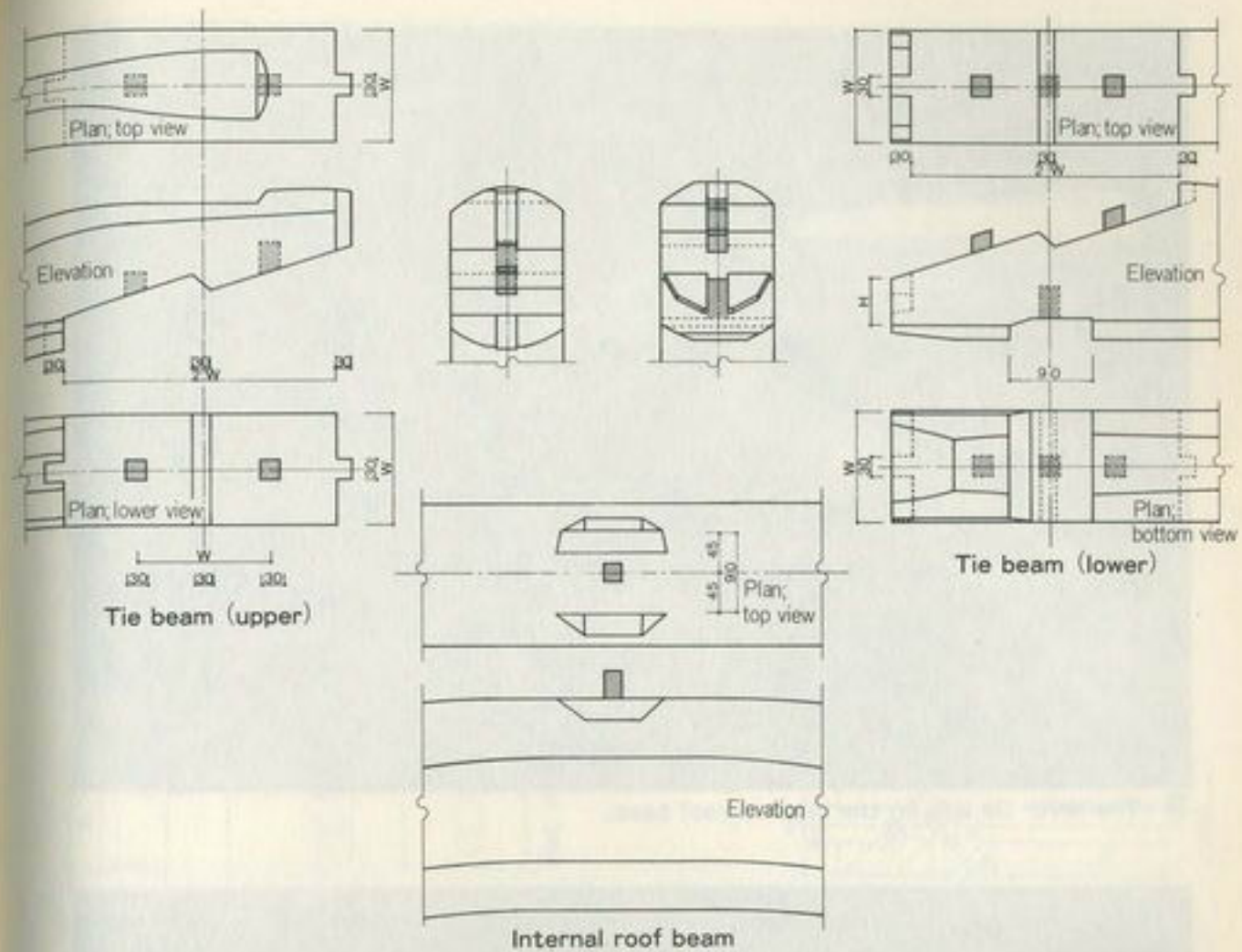
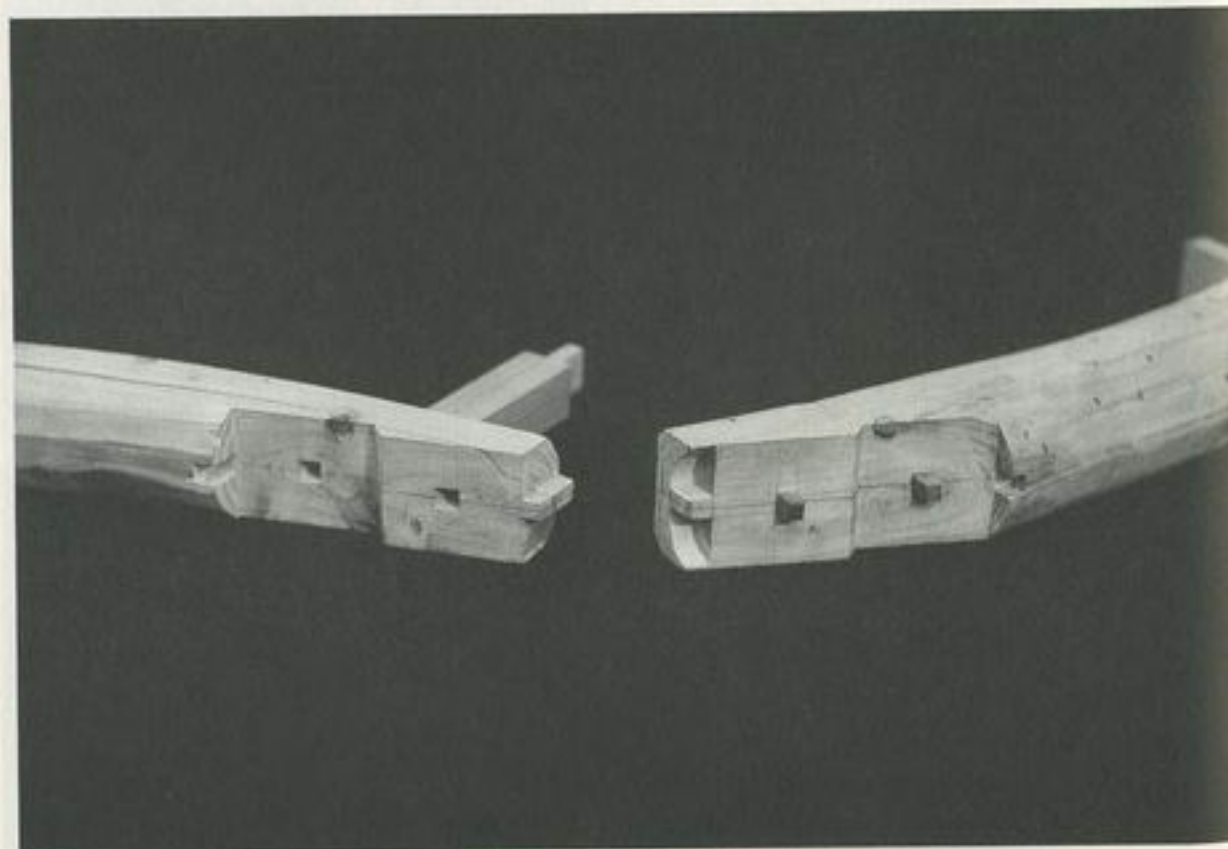
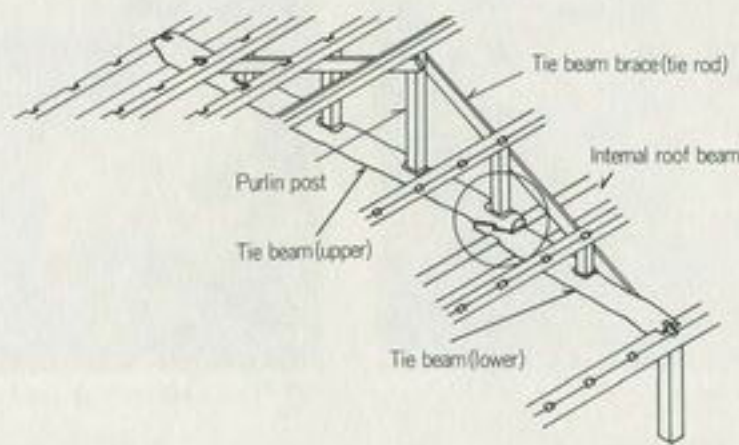

① Internal roof beam

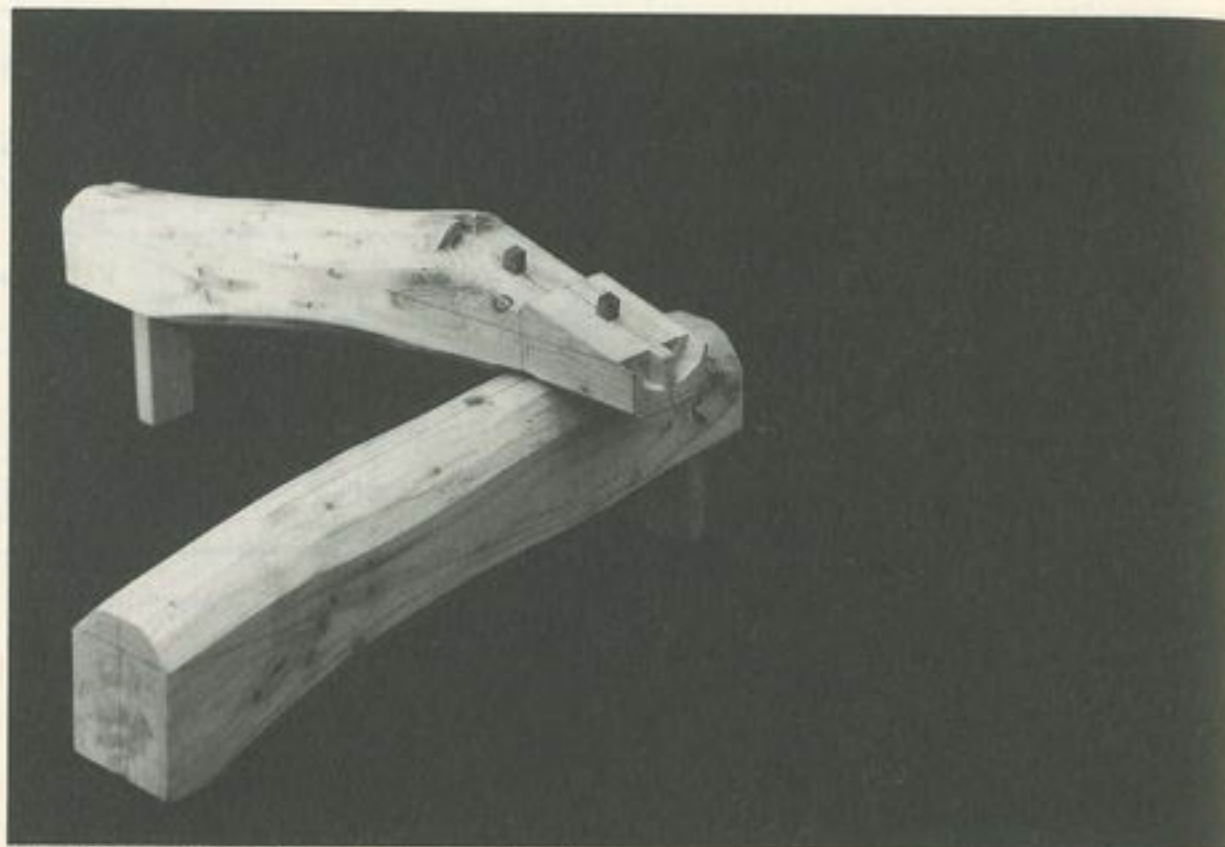

② The lower tie sits on the internal roof beam.

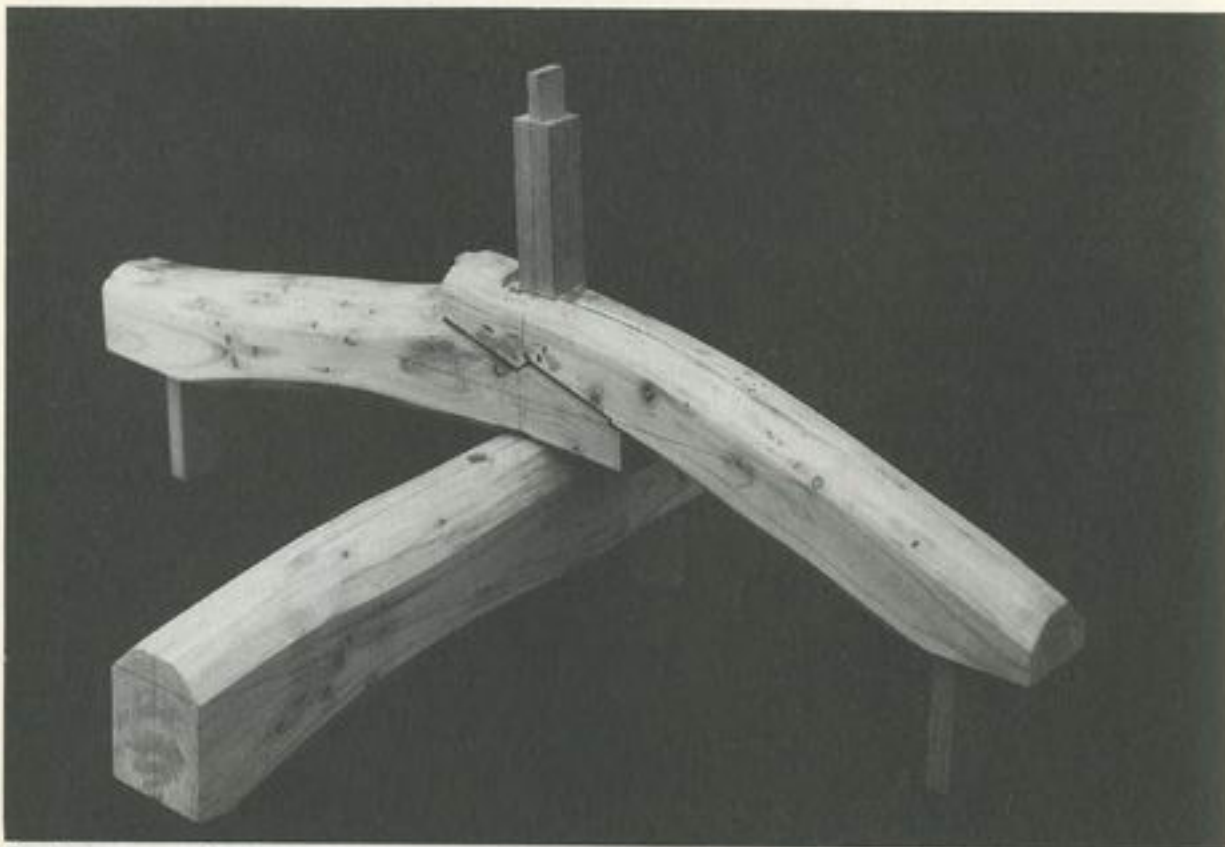

③ The upper tie beam sits on the lower tie beam. A purlin post is added to the assembly.

● CONNECTING JOINT 12 ●

Hip rafter joint

(Yosemune no sumi)

Three kinds of hip rafter joint with five sun pitch will be introduced (one sun is one tenth of a foot). All of these joints have common characteristics. The roof rafters (including corner's eave brackets) are normal to each other and all of them have the same pitch.

(1) Tee-shaped girder joint

Precisely manufactured tenon and mortise (goya hozo sashi) are necessary to

make this joint. The hip rafter (sumigi) sits on top of the longer girder. An eccentric tenon and mortise serves to assemble the eave girders.

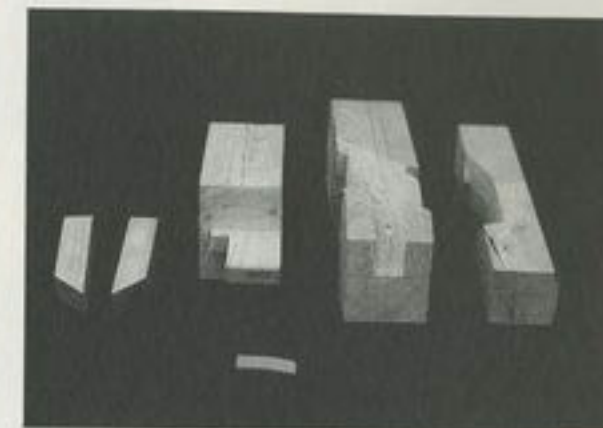

From left to right: Corner's eave brackets, girder (A), girder (B), hip rafter

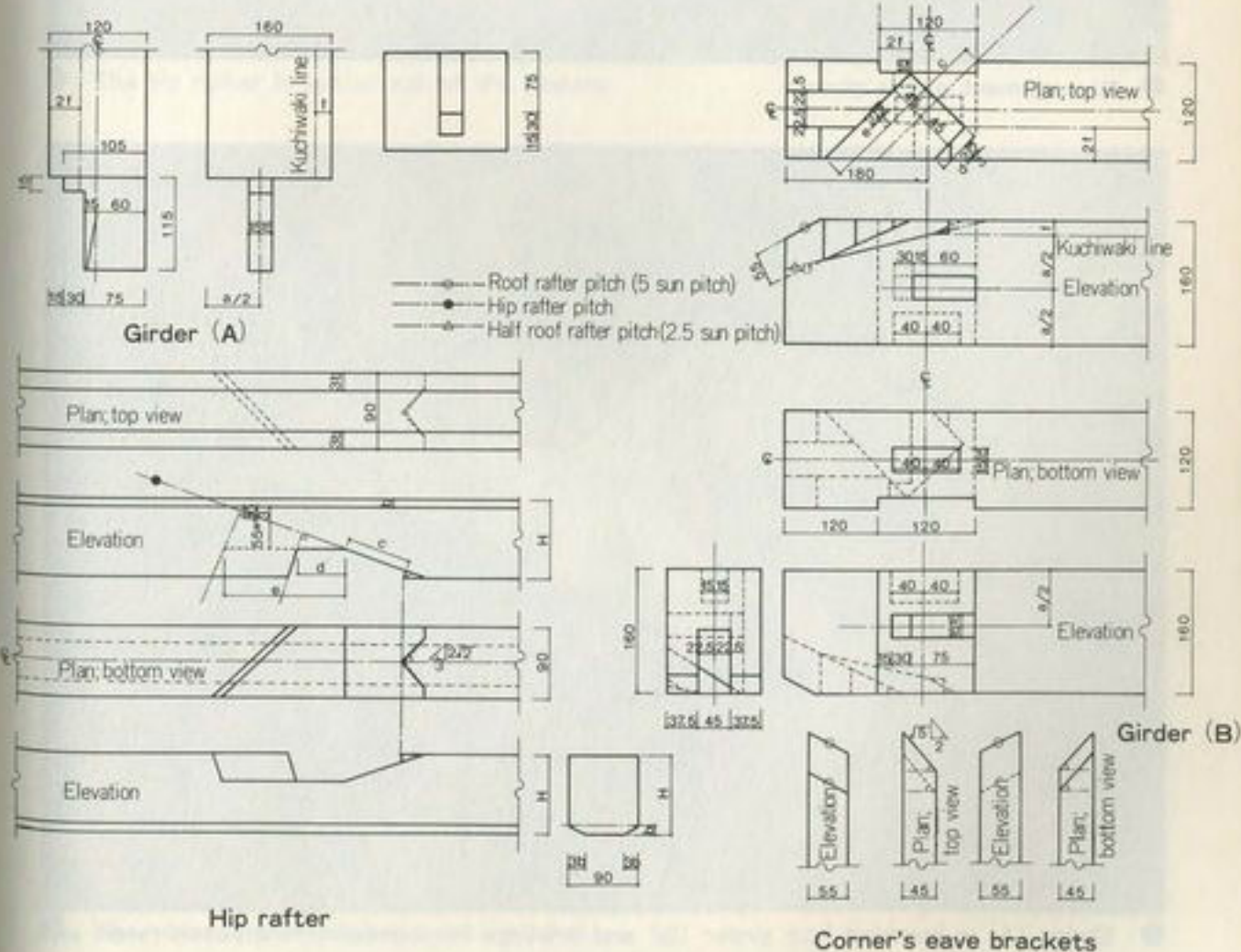

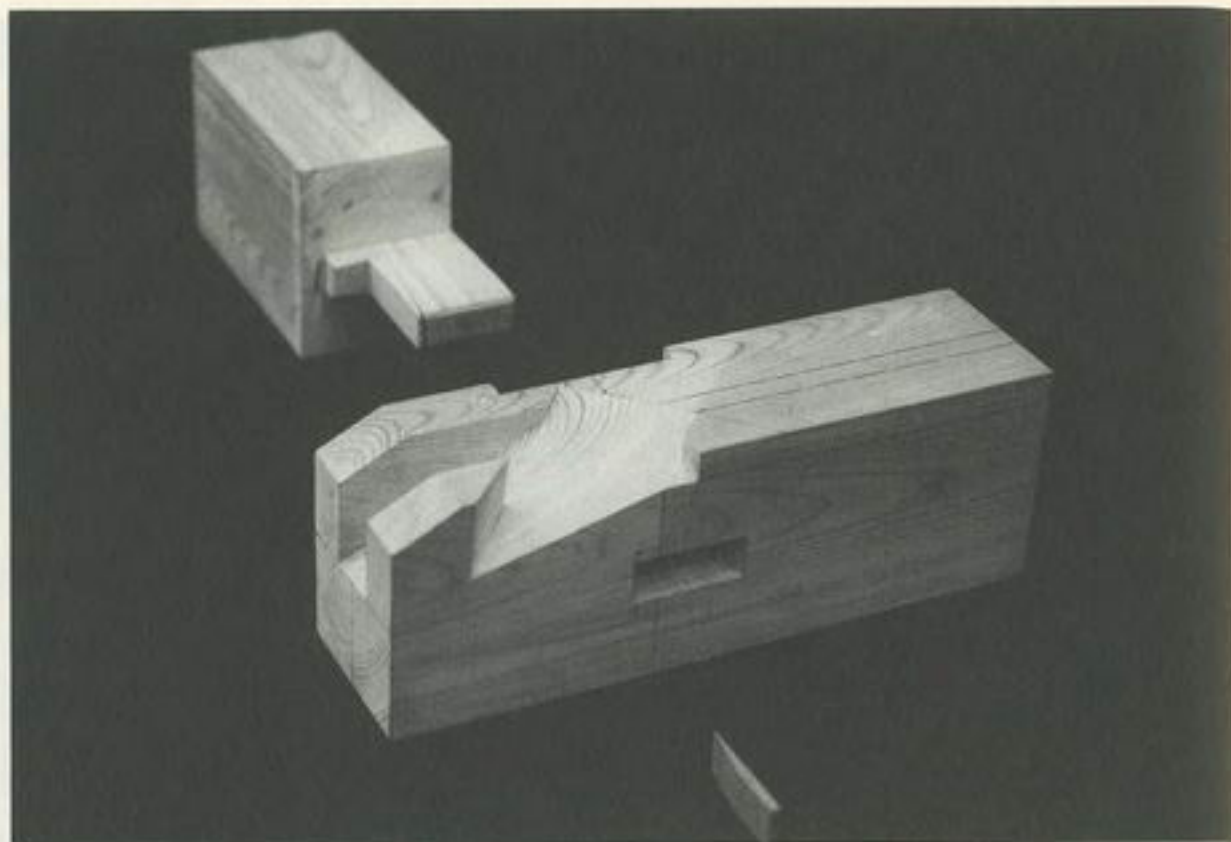

① Arrangement of the girders

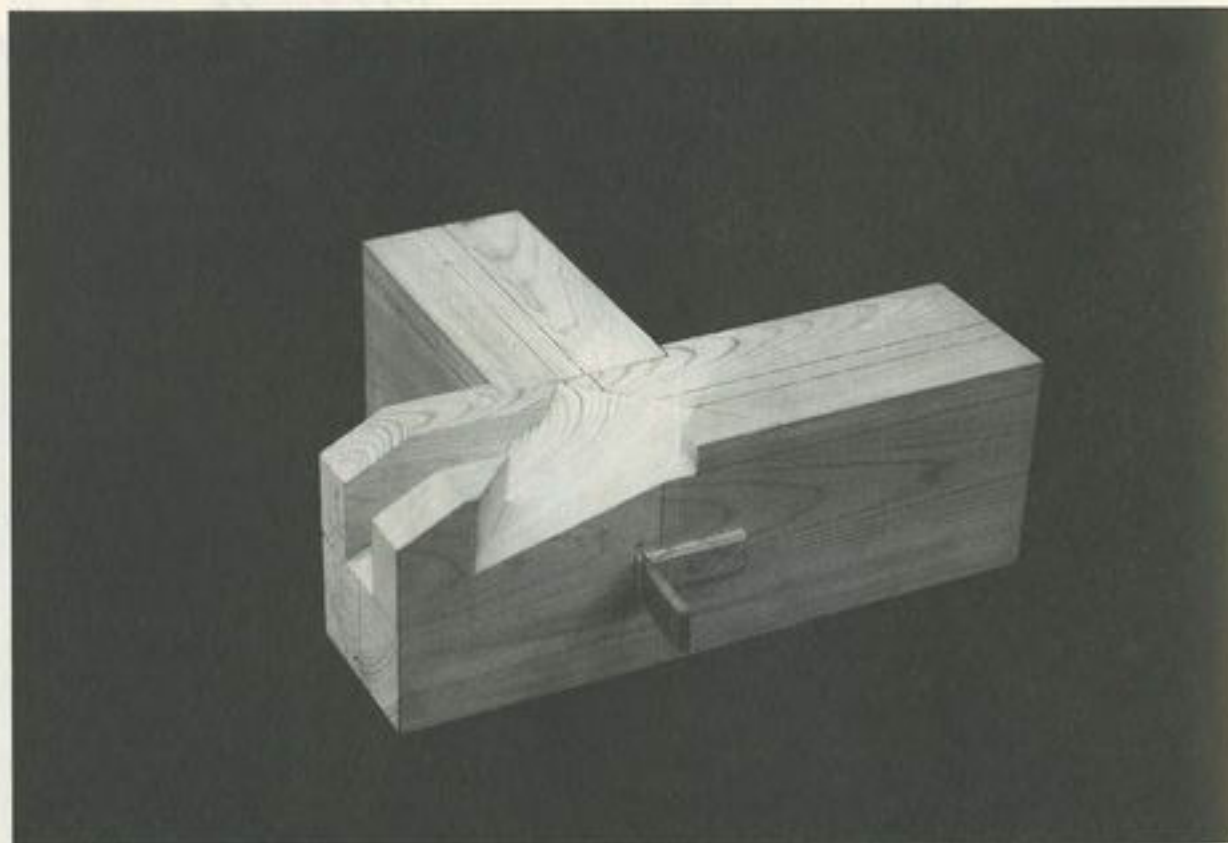

② Girder (A) is inserted into girder (B) and a wedge is pounded in (rabbeted tenon and mortise).

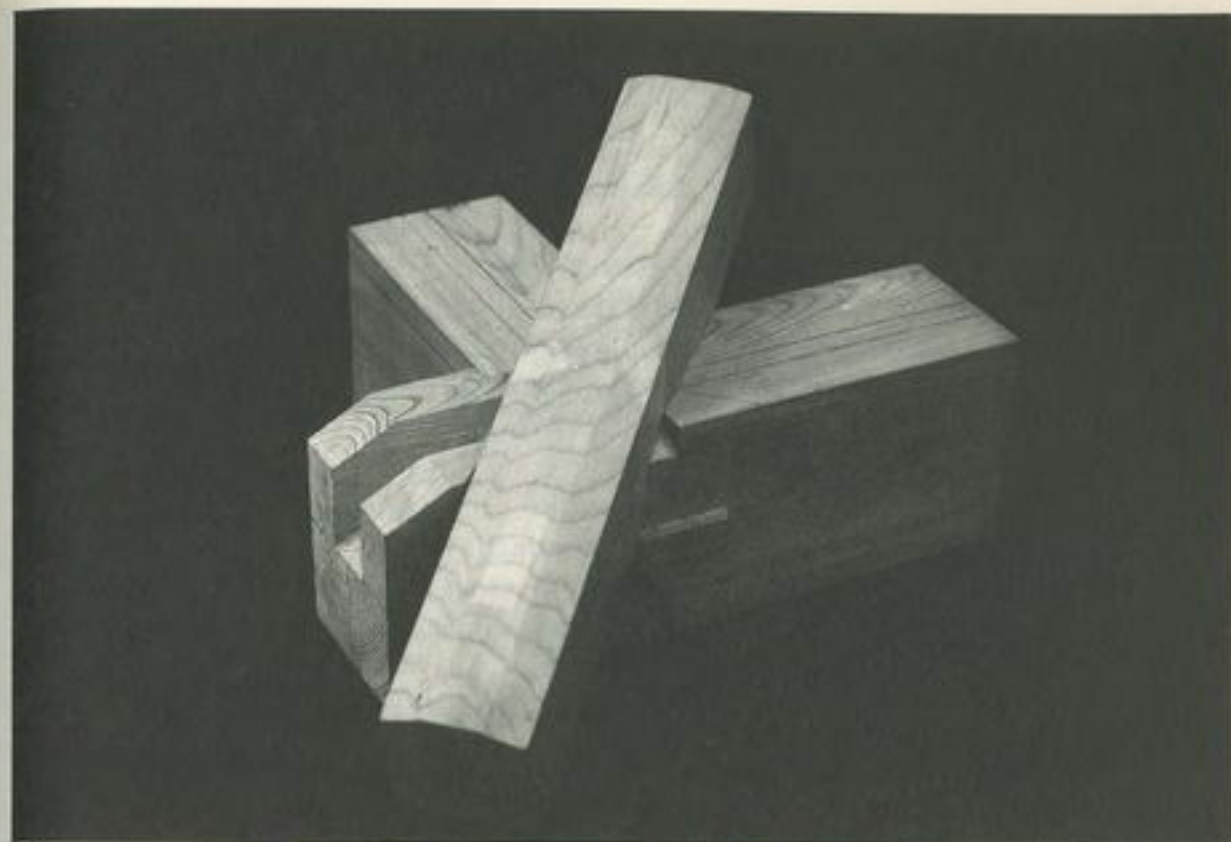

③ The hip rafter is set on top of the girders.

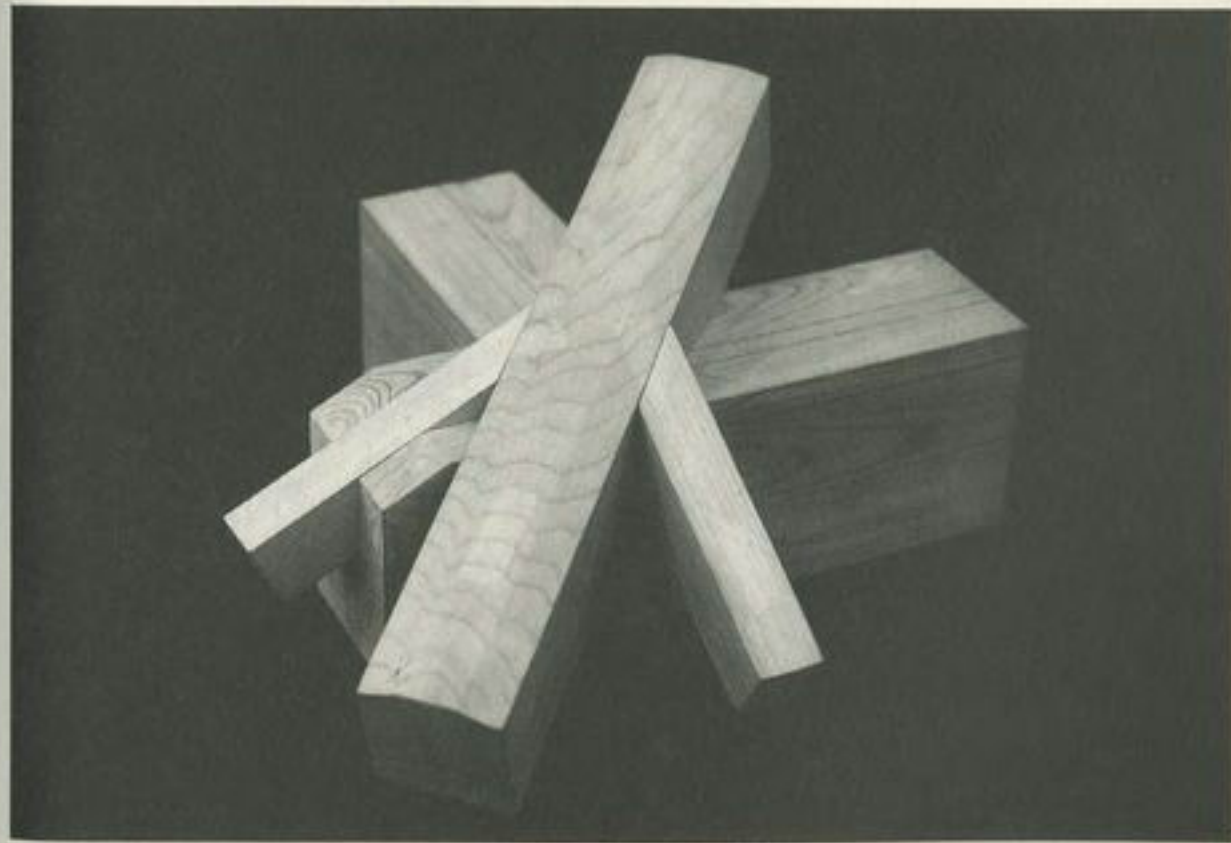

④ The corner's eave brackets are installed.

Layout (1)

A carpenter square is used to layout the dimensions on site. One side of the carpenter square has a 1:1 scale. The other side has a 1: $\sqrt{2}$ scale.

Figure a) shows how to layout the dimensions for the rafter sockets on the eave girders. On girder I, a line is extended down from the "toge" (point A) with the same pitch as the rafters' (5 sun pitch). This line intersects girder I on the top face and outer face at point B and point C respectively. Two lines, parallel to the center line of the girder, are layed out from point B and point C to the intersection with girder II at point G and point D. Line CD is extremely important. It is called the "Kuchiwaki" line. From point D another line is layed out with the same pitch as the roof rafter's. This line intersects the end face of girder II at point E. Line EF is drawn across the face, parallel to the top surfaces of the girders. The planes STUV and WXYZ represent the bottom faces of the grooves destined to receive the rafters.

The layout for the hip rafter is displayed on figure b). We have just explained how point B and C were created from the "toge" (point A) on girder I. In the same fashion, point B' and C' are established on girder II. The Kuchiwaki line from point C' and its counterpart on the top surface from point B', are drawn along girder II. Line B'H - intersects the inner face of girder I at point H (line B'H is parallel to girder's II center line RQ just as line BG is parallel to girder's I center line PQ).

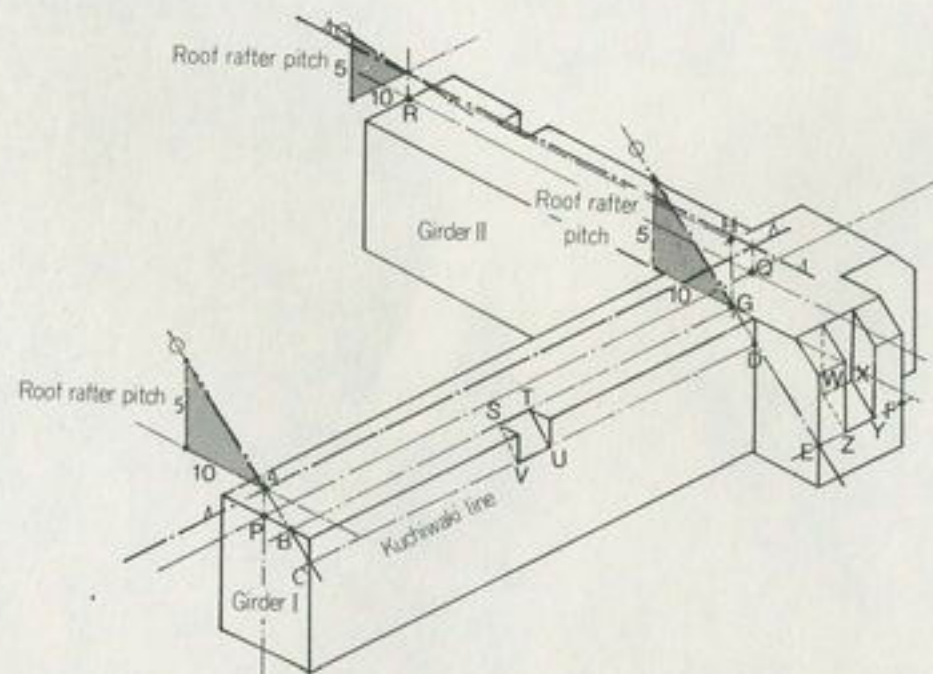

(a) Girders layout with notches for rafters (including corner eave brackets)

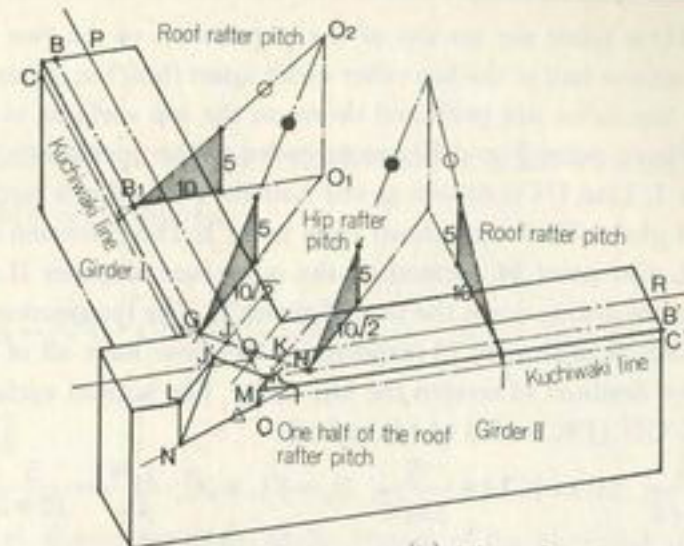

(b) Hip rafter layout

(c) Layout for the lateral pitch of the top surface of the hip rafter

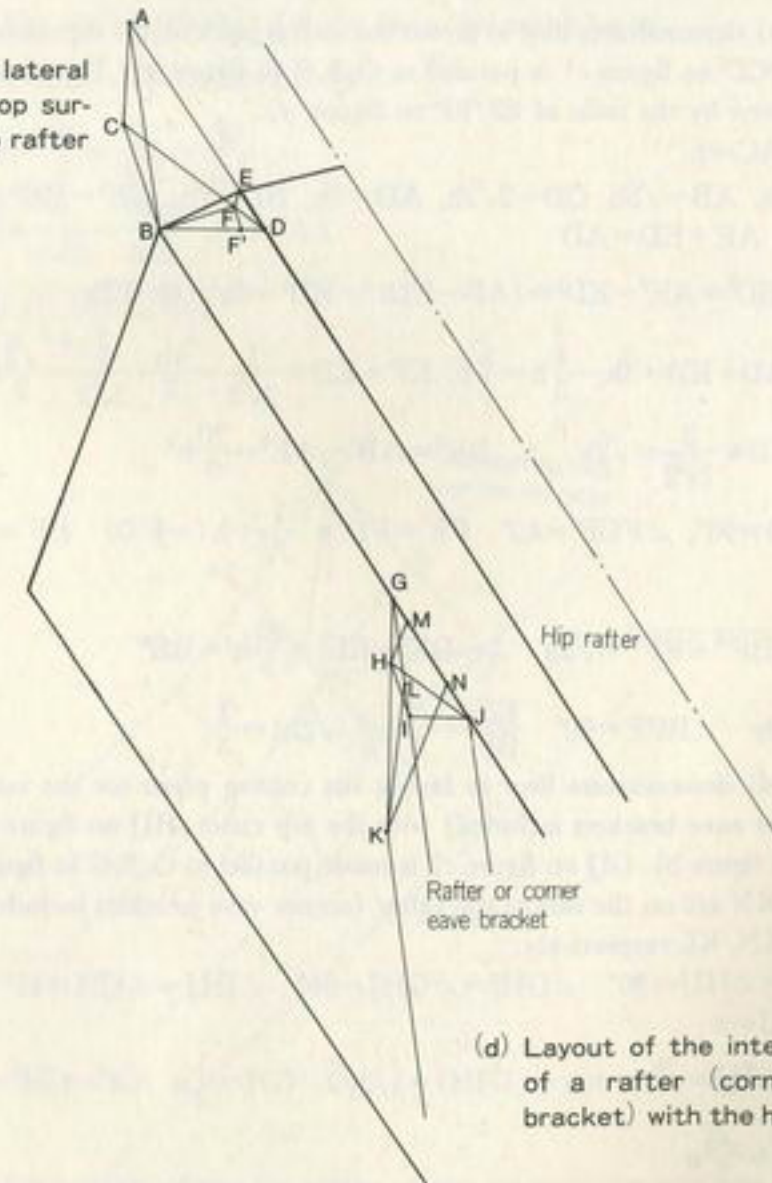

(d) Layout of the intersection of a rafter (corner eave bracket) with the hip rafter

A new line, GH, is laid out on top of the intersection of the two girders. Two more points, J and K are set one half of the hip rafter width apart from the center point H and point G. The sides of the hip rafter are projected down on the top surfaces to form lines JJ' and line KK'. On those lines, point J' and K' are extended to the intersection with the outer face of girder II at point I. Line IN is drawn at one half the roof rafter's pitch (2.5 suns pitch) on the outer face of girder II, sloping down from point I. The extension of line JJ' and line KK' give us point L and point M, located on the outer face of girder II. From point L and M, two vertical lines are drawn down the face of girder II. The intersection of these lines with line IN produces point N and point O respectively. We now have all of the lines necessary to cut out the groove destined to receive the hip rafter. The bottom surface of the groove is included within J'K'ON. (J'K':width of hip rafter)

$$LN = JL * \frac{5}{10\sqrt{2}}, MO = K'M * \frac{5}{10\sqrt{2}}, IL = J'L * \sqrt{2}, \frac{LN}{IL} = \frac{5}{10 * 2}$$

Figure c) demonstrates how to layout the lateral pitch on the top surface of the hip rafter. The plane BCD on figure c) is parallel to O_2B_1G in figure b). The lateral pitch of the top surface is given by the ratio of EF/BF on figure c).

Assume $AC = h$

$$CB = 2h, AB = \sqrt{5}h, CD = 2\sqrt{2}h, AD = 3h, BD = 2h, AB^2 - BE^2 = AE^2, BD^2 - BE^2 = ED^2, AE + ED = AD$$

$$AB^2 - BD^2 = AE^2 - ED^2 = (AD - ED)^2 - ED^2 = 9h^2 - 6h \cdot ED \quad \therefore ED = \frac{4}{3}h$$

$$AE = AD - ED = 3h - \frac{4}{3}h = \frac{5}{3}h, EF = ED * \frac{1}{2\sqrt{2}} = \frac{4h}{3} * \frac{1}{2\sqrt{2}} = \frac{\sqrt{2}}{3}h$$

$$FD = ED * \frac{3}{2\sqrt{2}} = \sqrt{2}h \quad \therefore BE^2 = AB^2 - AE^2 = \frac{20}{9}h^2$$

$$\angle FF'D = 90^\circ, \angle FDF' = 45^\circ \quad FF' = FD * \frac{1}{\sqrt{2}} = h (= F'D) \quad BF' = BD - F'D = 2h - h = h$$

$$BF = \sqrt{BF'^2 + FF'^2} = \sqrt{2}h \quad \therefore BF^2 + EF^2 = \frac{20}{9}h^2 = BE^2$$

consequently $\angle BFE = 90^\circ \quad \frac{EF}{BF} = \frac{\frac{\sqrt{2}}{3}h}{(\sqrt{2}h)} = \frac{1}{3}$

Figure d) demonstrates how to layout the cutting plane for the intersection of a roof rafter (corner eave brackets included) with the hip rafter. HIJ on figure c) is made parallel to O_1B_1G in figure b). GIJ on figure c) is made parallel to O_2B_1G in figure b). The surfaces GHJ and GKN are on the side of the rafter (corner eave brackets included). Their pitch are GI/IJ and KN/KL respectively.

$$\angle GIJ = \angle HIJ = 90^\circ \quad \angle GHI = \angle GHJ = 90^\circ \quad \angle IHJ = \angle IJH = 45^\circ$$

Assume $IJ = a$

$$HI = a \quad HJ = \sqrt{2}a \quad \tan(\angle GJH) = 1/2\sqrt{2} \quad GH = \frac{1}{2}a \quad GI^2 = GH^2 + HI^2 = \frac{5}{4}a^2$$

$$\therefore GI = \frac{\sqrt{5}}{2}a$$

consequently

$$GI/IJ = \frac{\sqrt{5}}{2}$$

$$\angle KLI = \angle KLG = 90^\circ, \angle KNJ = \angle KNG = 90^\circ, \angle HMG = \angle HMJ = 90^\circ$$

$$GH = \frac{1}{2}a \quad GM = \frac{1}{2}a * \frac{1}{3} = \frac{1}{6}a$$

Assume $KL = h$

$$GL = \frac{1}{2}h \quad GK = \frac{\sqrt{5}}{2}h \quad GN = \frac{GK}{3} = \frac{\sqrt{5}}{6}h \quad \therefore KN = \frac{\sqrt{5}}{6}h * 2\sqrt{2} = \frac{\sqrt{10}}{3}h$$

consequently

$$KN/KL = \frac{\sqrt{10}}{3}$$

Finally, figure e) shows the layout of the bottom of the hip rafter where it contacts the girder. XYZ in figure e) is made parallel to O_1B_1G in figure b). ZYD and XYD contact the face of the girder. The pitch is FX/FD. Let the hip rafter width be W.

$$CY = EY = CX = EZ = AD = DB = XF = FZ = \frac{W}{2}$$

$$AC = YD = BE = \frac{W}{2} * \frac{1}{2\sqrt{2}} = \frac{W}{4\sqrt{2}}$$

$$AX = BZ = \frac{W}{2} * \frac{3}{2\sqrt{2}} = \frac{3W}{4\sqrt{2}} \quad FD = AX$$

$$FX/FD = \frac{1}{2}W / \left(\frac{3W}{4\sqrt{2}}\right) = \frac{2\sqrt{2}}{3}$$

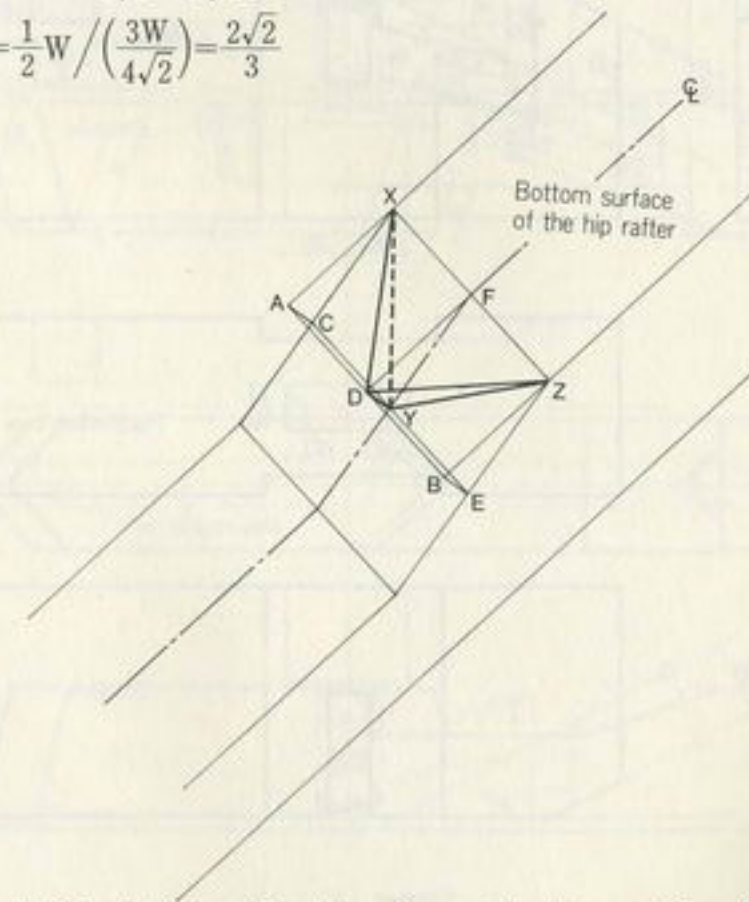

(e) Layout of the bottom of the hip rafter at the intersection with the girder

(2) Cross-shaped girder joint

In practice the girders join together in a Tee-shaped assembly. Afterward, a "nose" is added to the shorter girder, giving the joint the appearance of a cross.

- Roof rafter pitch (5 sun pitch)
- Hip rafter pitch
- △— Half roof rafter pitch (2.5 sun pitch)

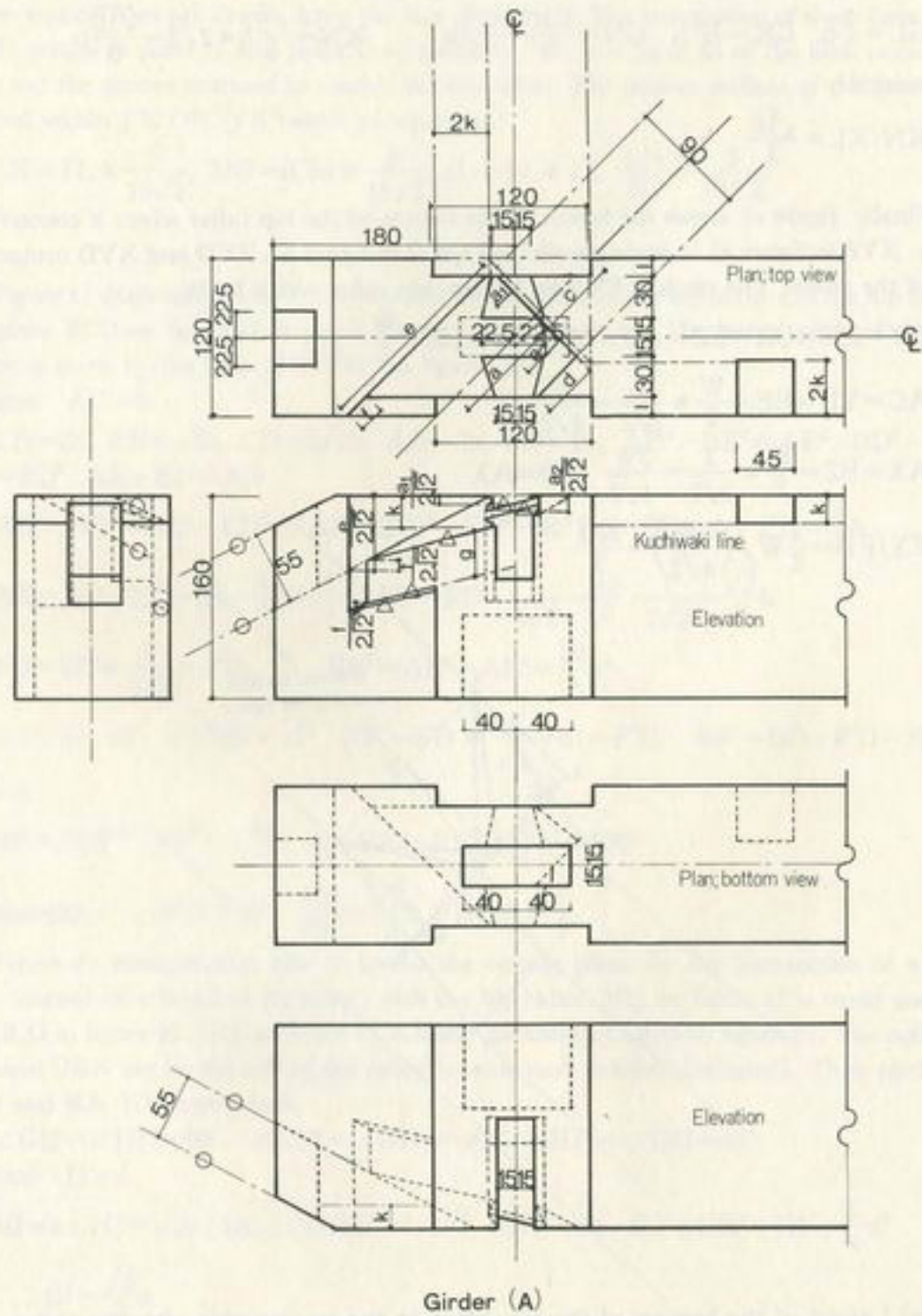

On top, from left to right: Girder B, girder nose, girder A, hip rafter
On the bottom: rafters

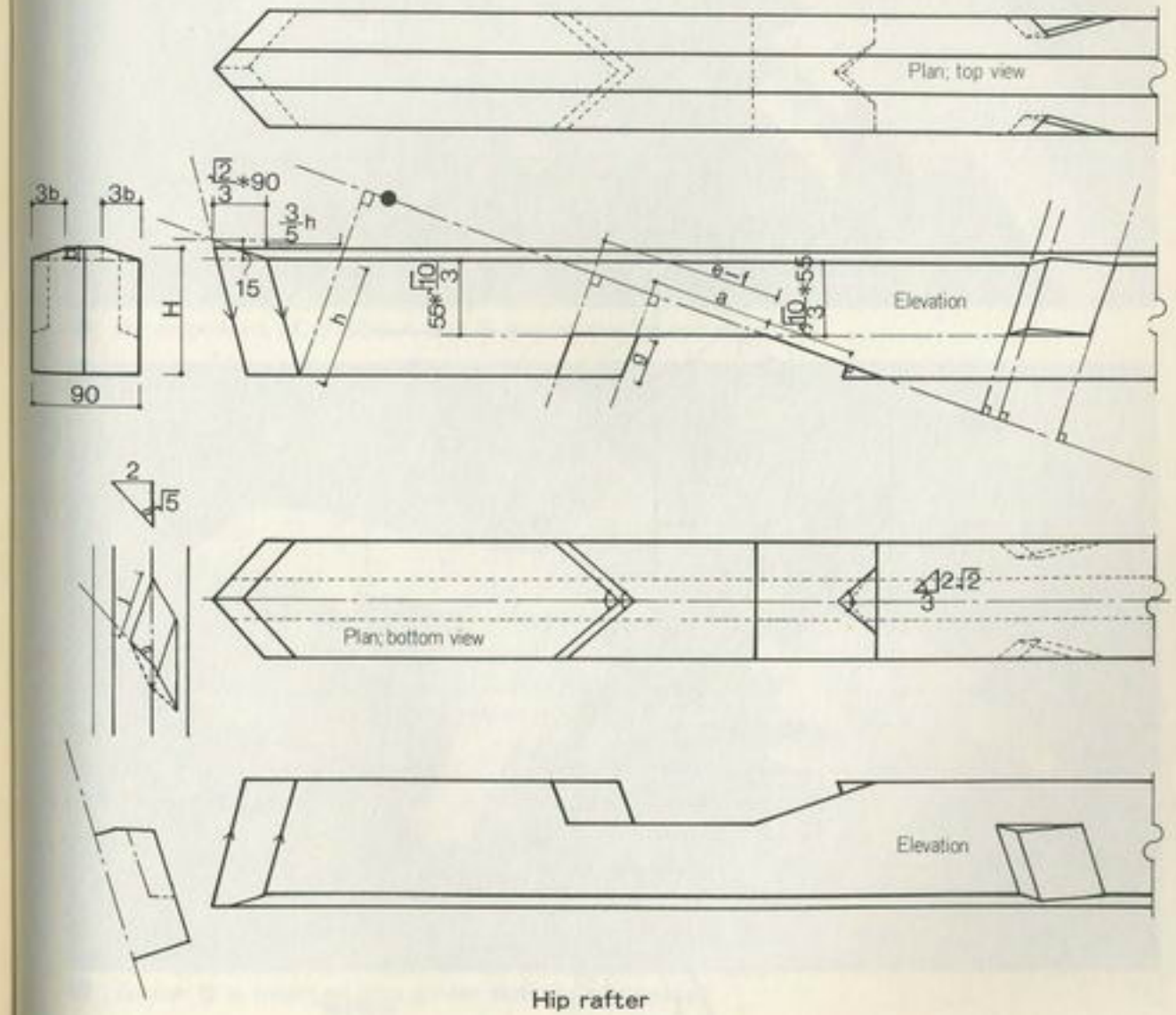
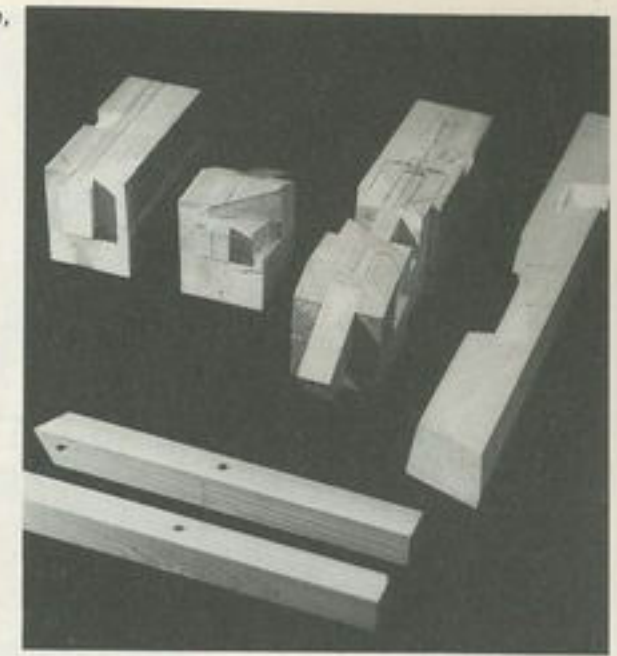

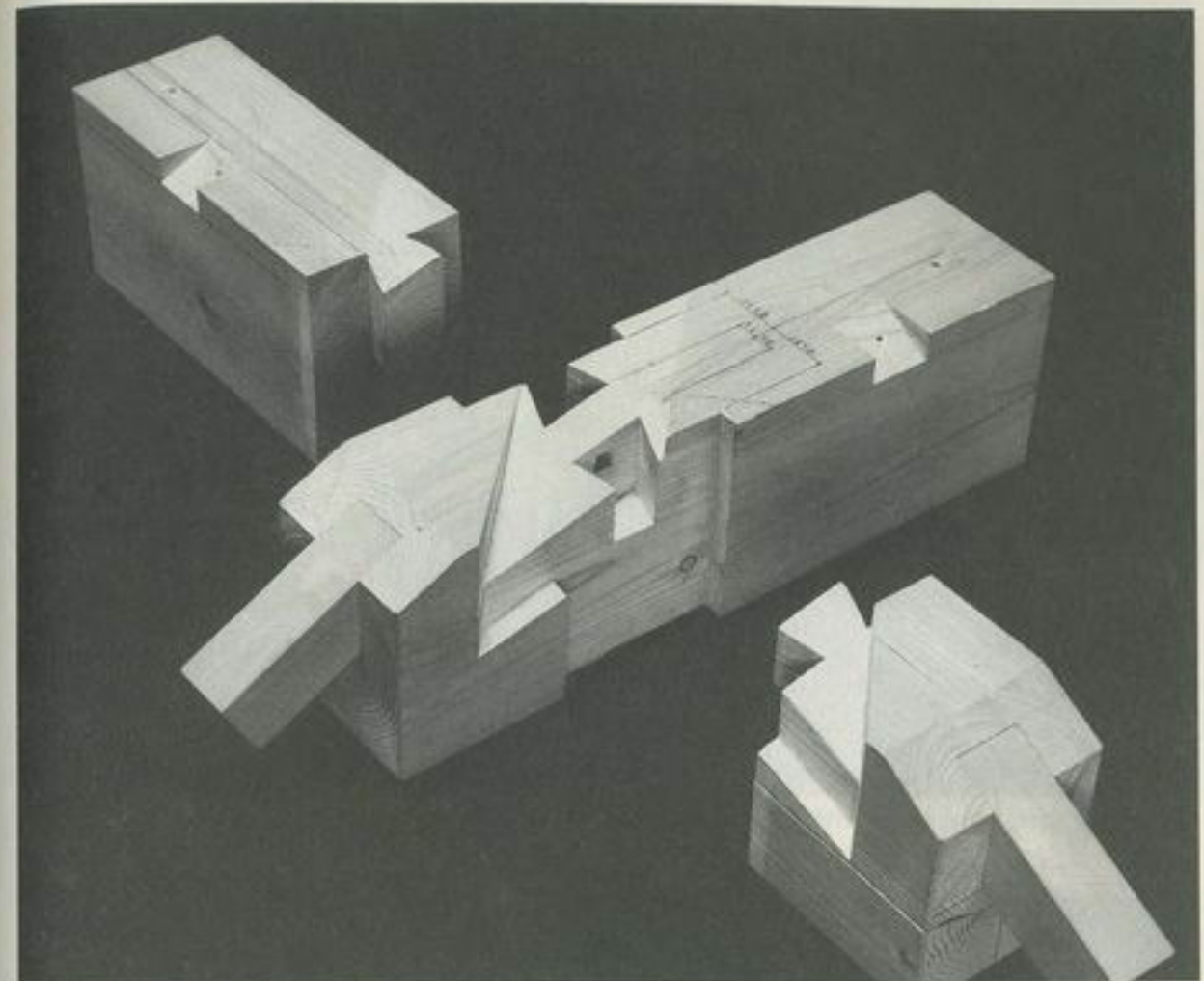
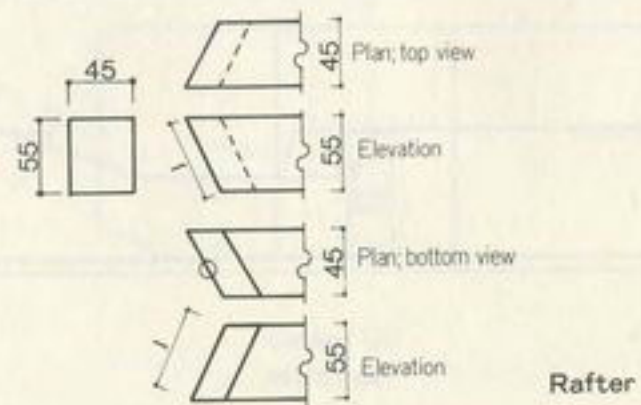
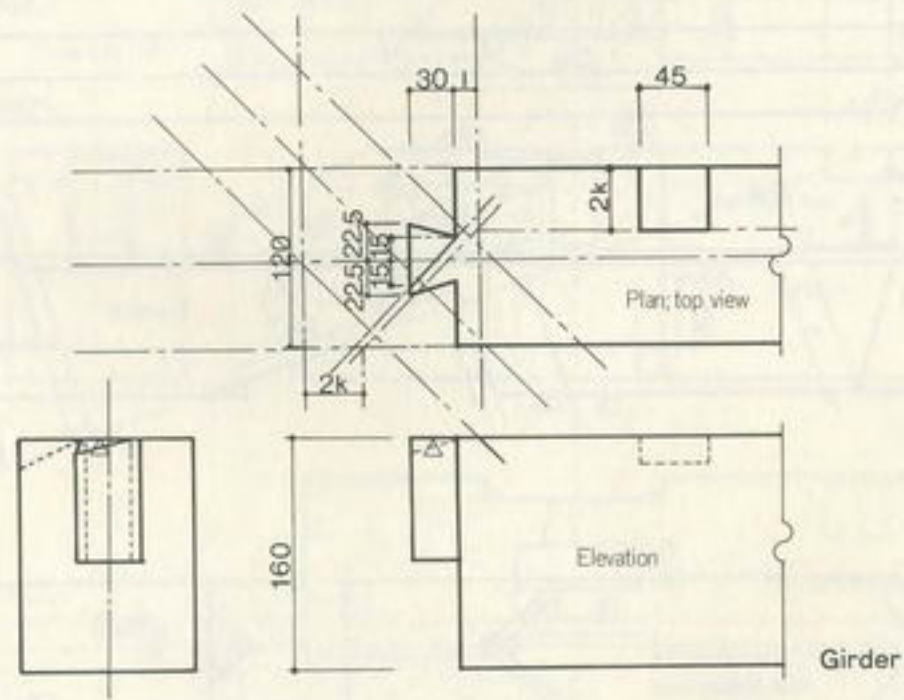
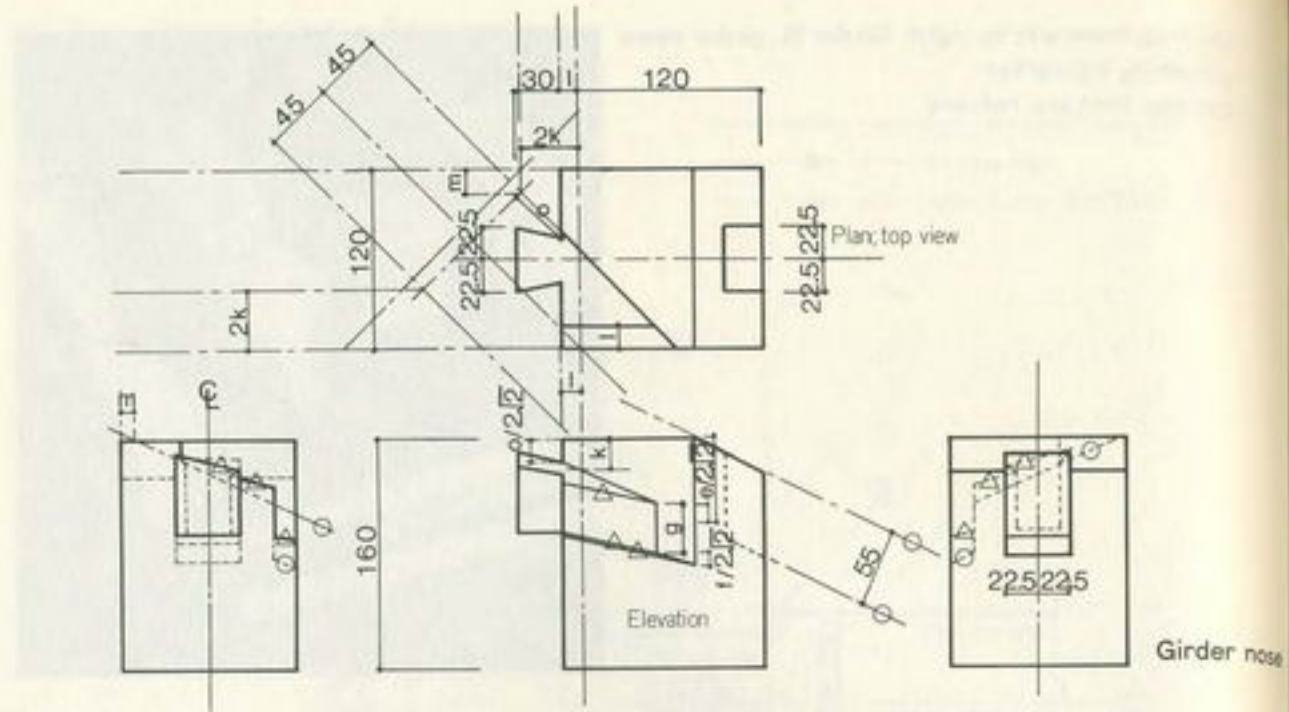

① Arrangement of girders A and B and of the girder nose

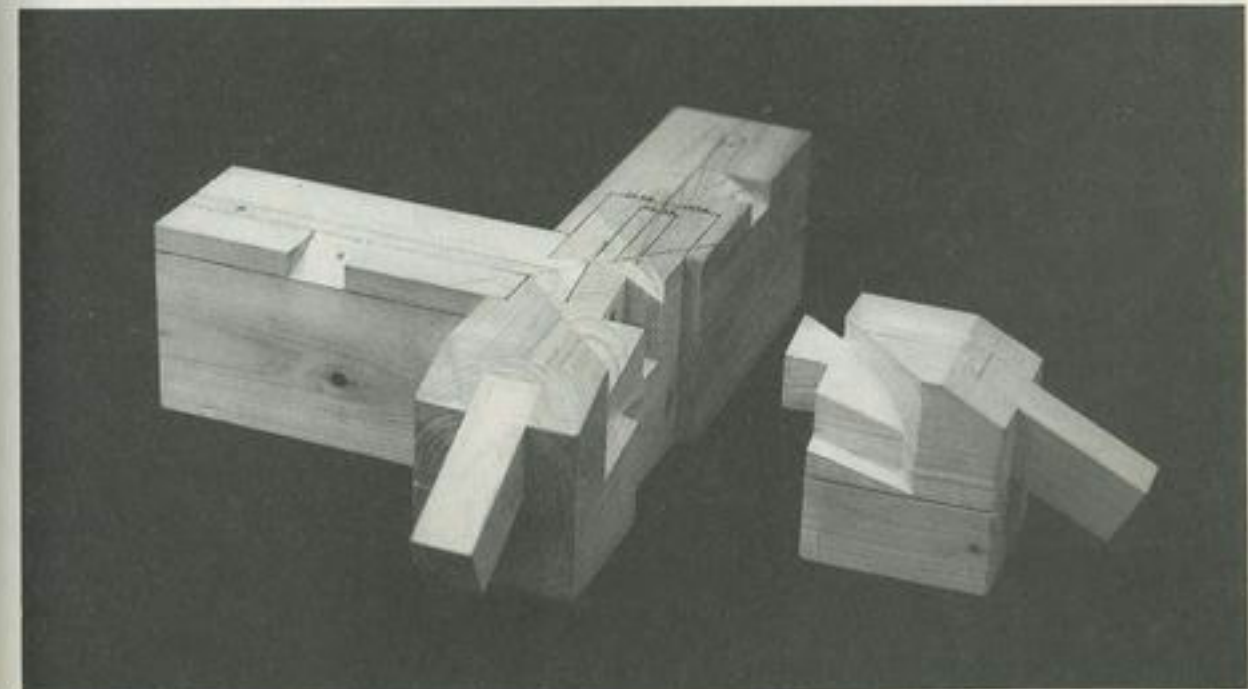

② Girder B is inserted into girder A (housed dovetail).

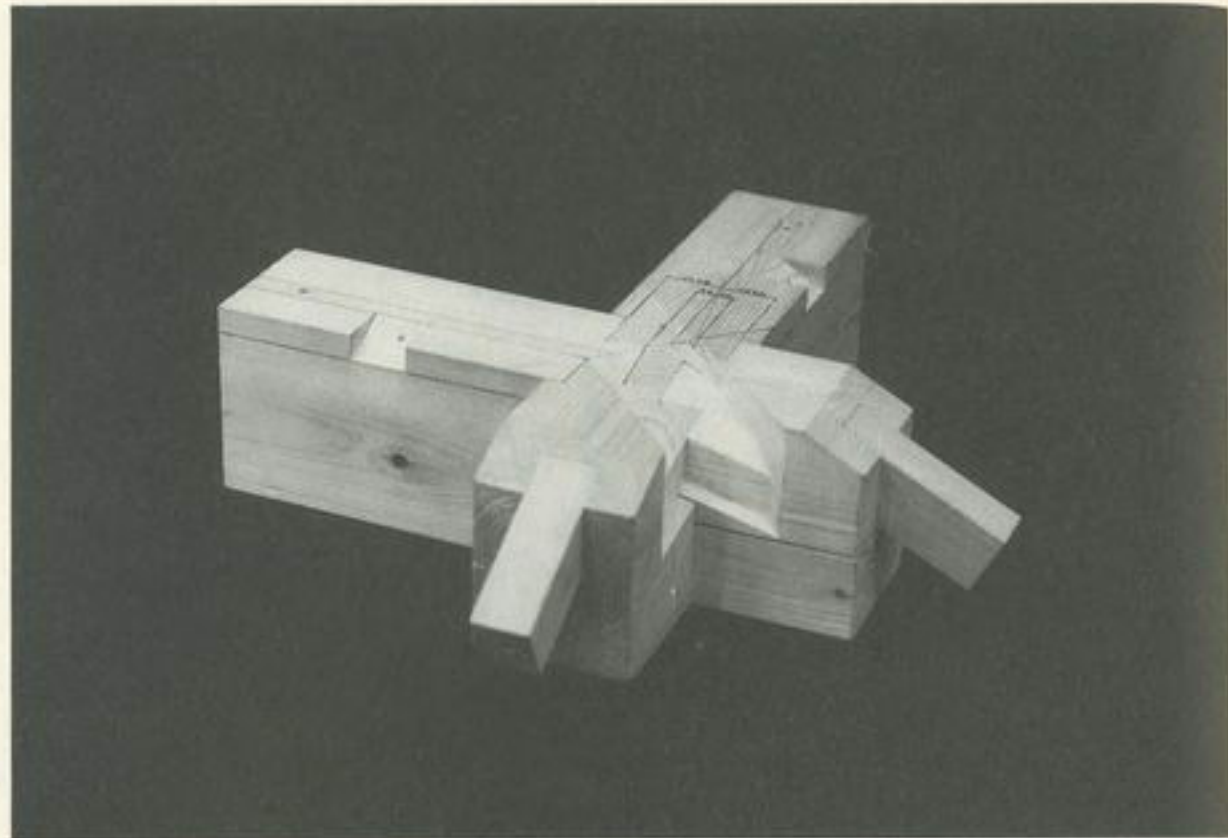

③ The girder nose slides into girder A (housed dovetail).

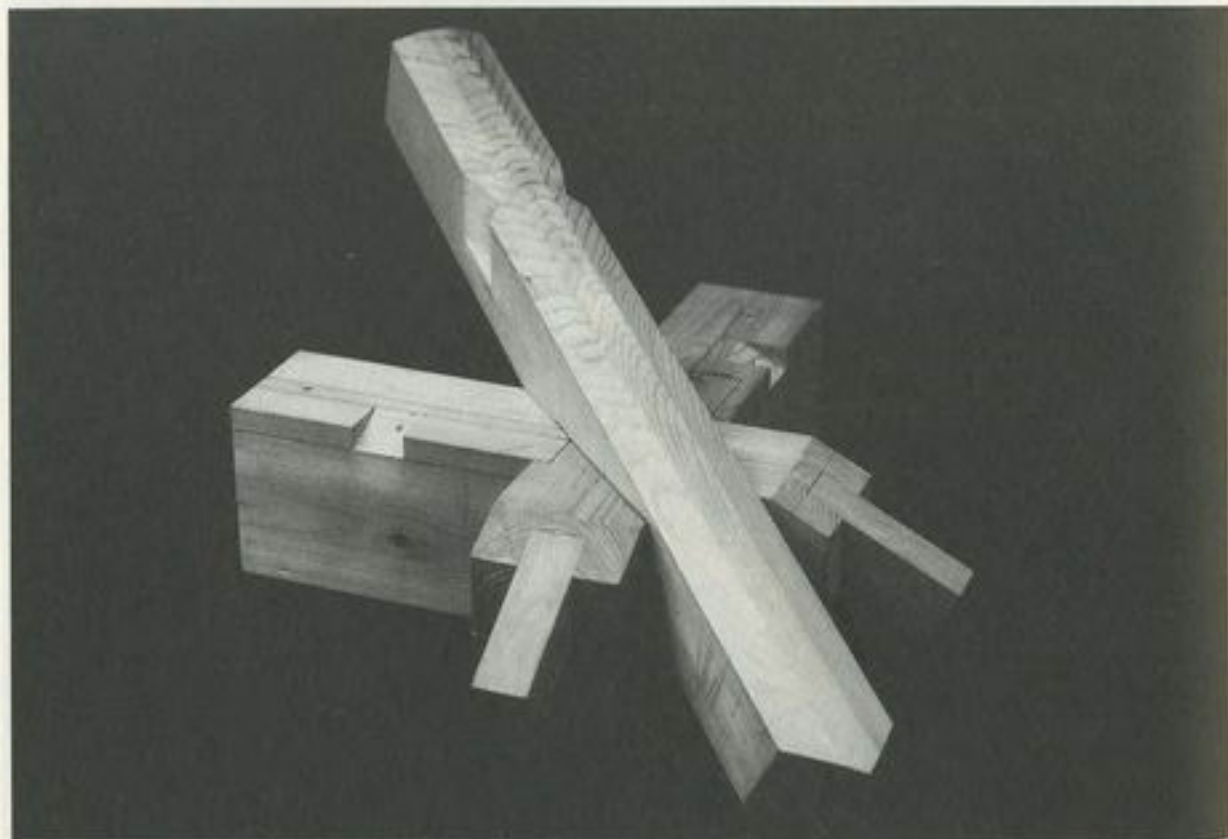

④ The hip rafter is set on top of the girders.

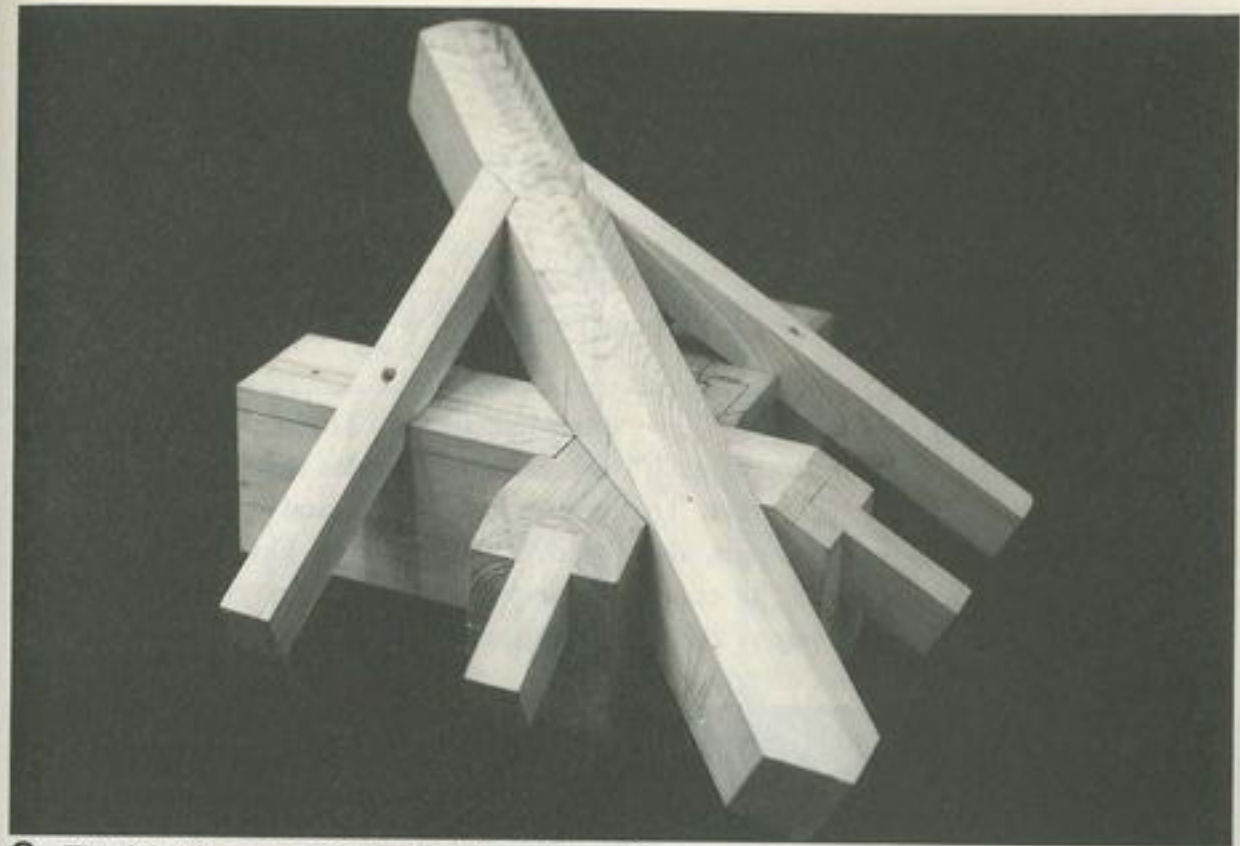

⑤ The joint is completed by installing the rafters.

Layout (2)

Note: The general layout discussed for the Tee-shaped girder joint will be omitted for the next two joints. Only new concepts need be introduced.

The layout of the end of the hip rafter is displayed in diagram b). The pitch of the hip rafter, called nagesumi pitch, depends on the roof rafters pitch (5 sun pitch) and is assumed perpendicular to the end surfaces of the hip rafters. The plan PRS is parallel to O_1B_1G in figure b). The plan ORS is parallel to O_2B_1G in figure b). OQS and OPS lay within the vertical face of the hip rafter. The values required are OQ, OS and TV respectively.

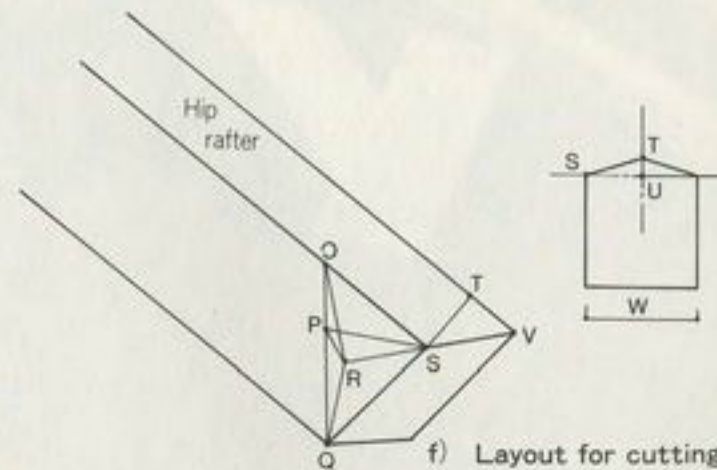

f) Layout for cutting the hip rafter's end
The surface OQS is normal to the fascia boards.

Assume $OP=h$

$$RS=PR=2h, PS=2\sqrt{2}h, OS=3h$$

since $\angle ORQ=90^\circ$

$$\angle POR=\angle PRQ \quad PQ=PR*2=4h \quad \therefore OQ=5h$$

$$ST=\sqrt{\left(\frac{W}{2}\right)^2+\left(\frac{W}{6}\right)^2}=\frac{\sqrt{10}}{6}W$$

$$\text{since } \angle OSR=\angle TVS \text{ with } OR/RS=\sqrt{5}/2, TV=\frac{\sqrt{10}}{6}W * \frac{2}{\sqrt{5}}=\frac{\sqrt{2}}{3}W$$

(3) Bevelled halving (nejigumi)

The eave girders cross on top of each other in a formation called hip corner. To balance the strength along both axis, the girder sections are carved out by an equal amount. This concept of joining is called bevelled halving. The girders overlap at

their intersection. The stepped tenon of the corner column slides through the intersection of the girders and extend beyond it, ready to receive the hip rafter. The hip rafter joins onto a rafter column set back from the corner column.

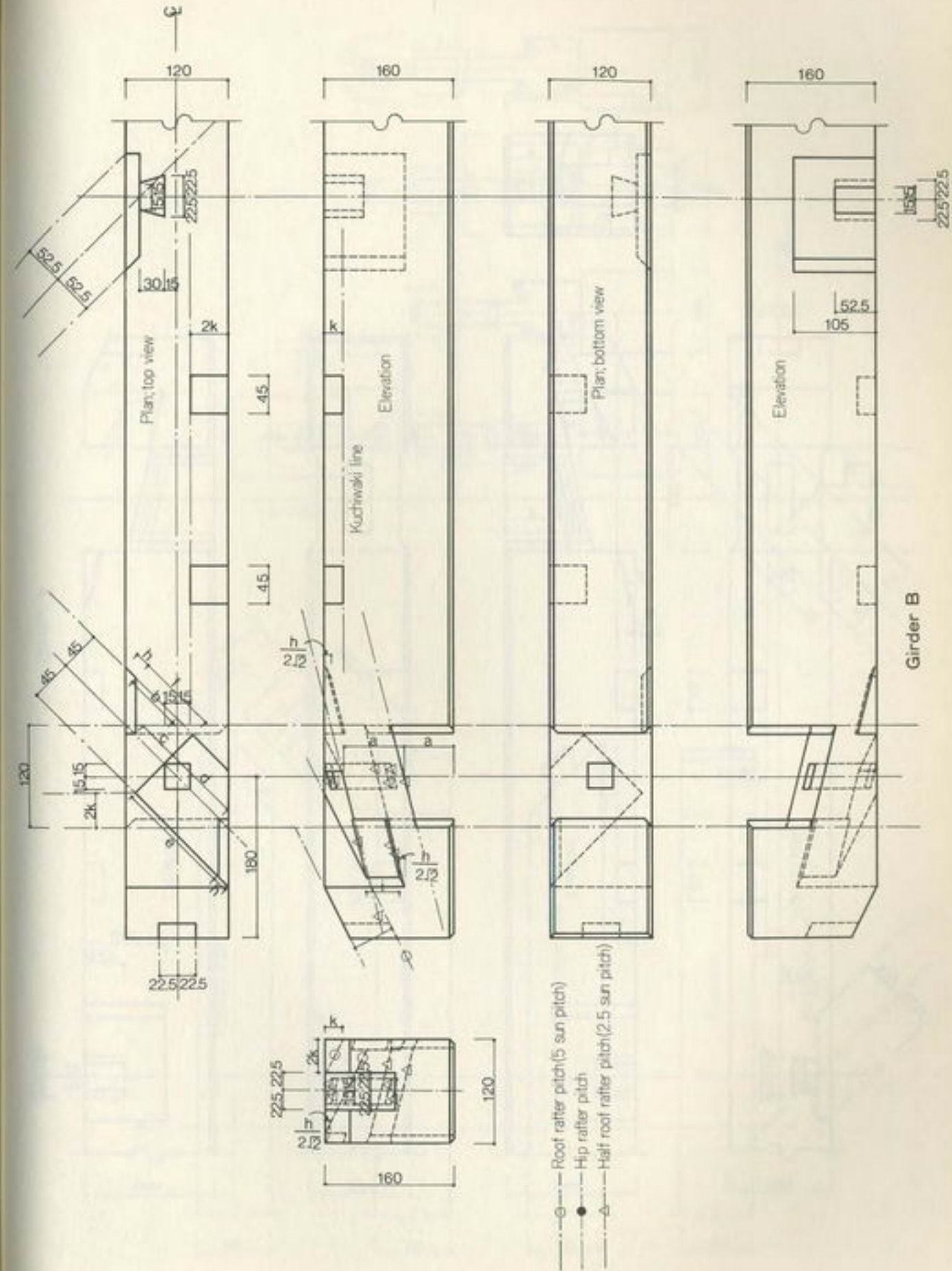
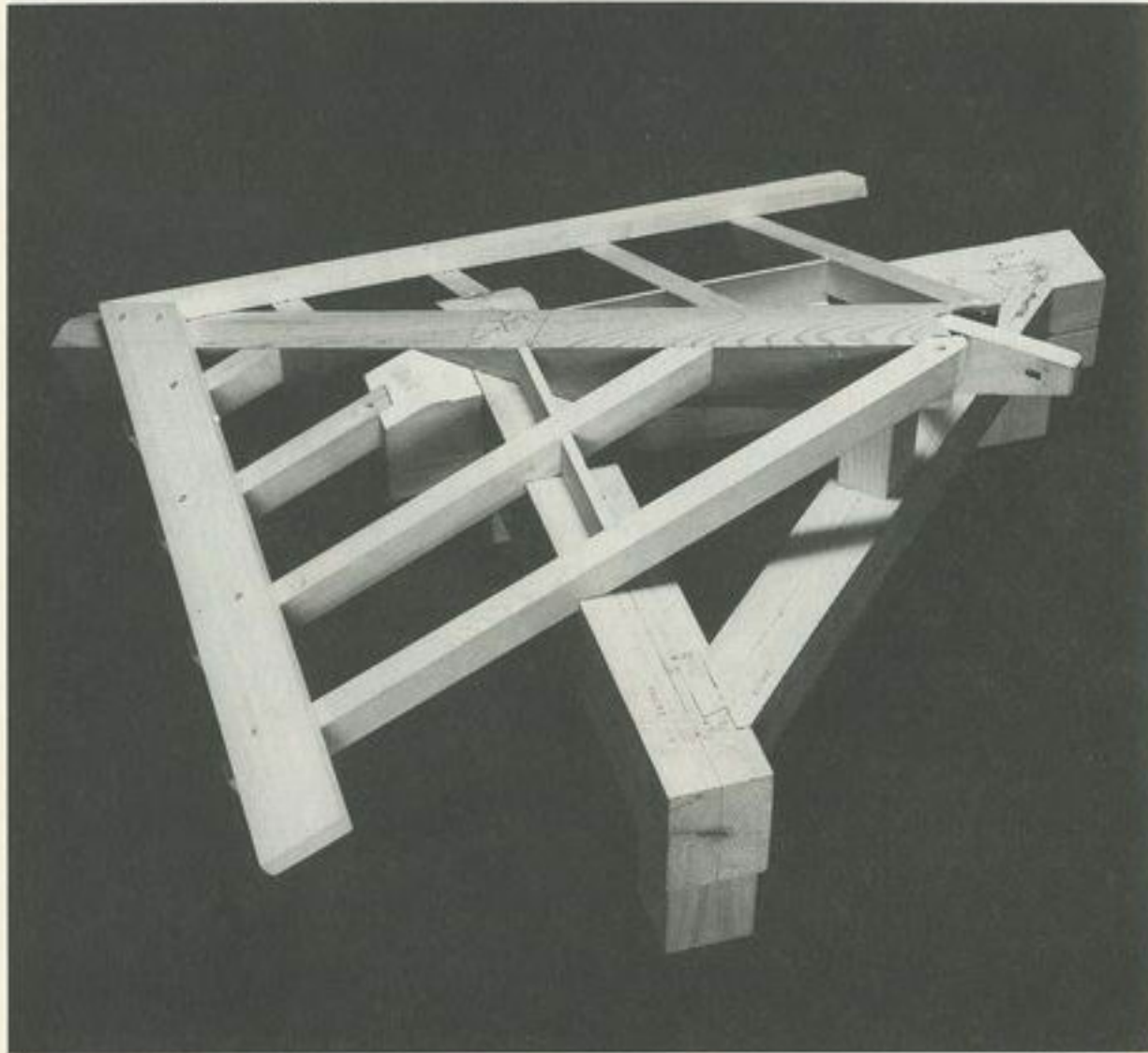

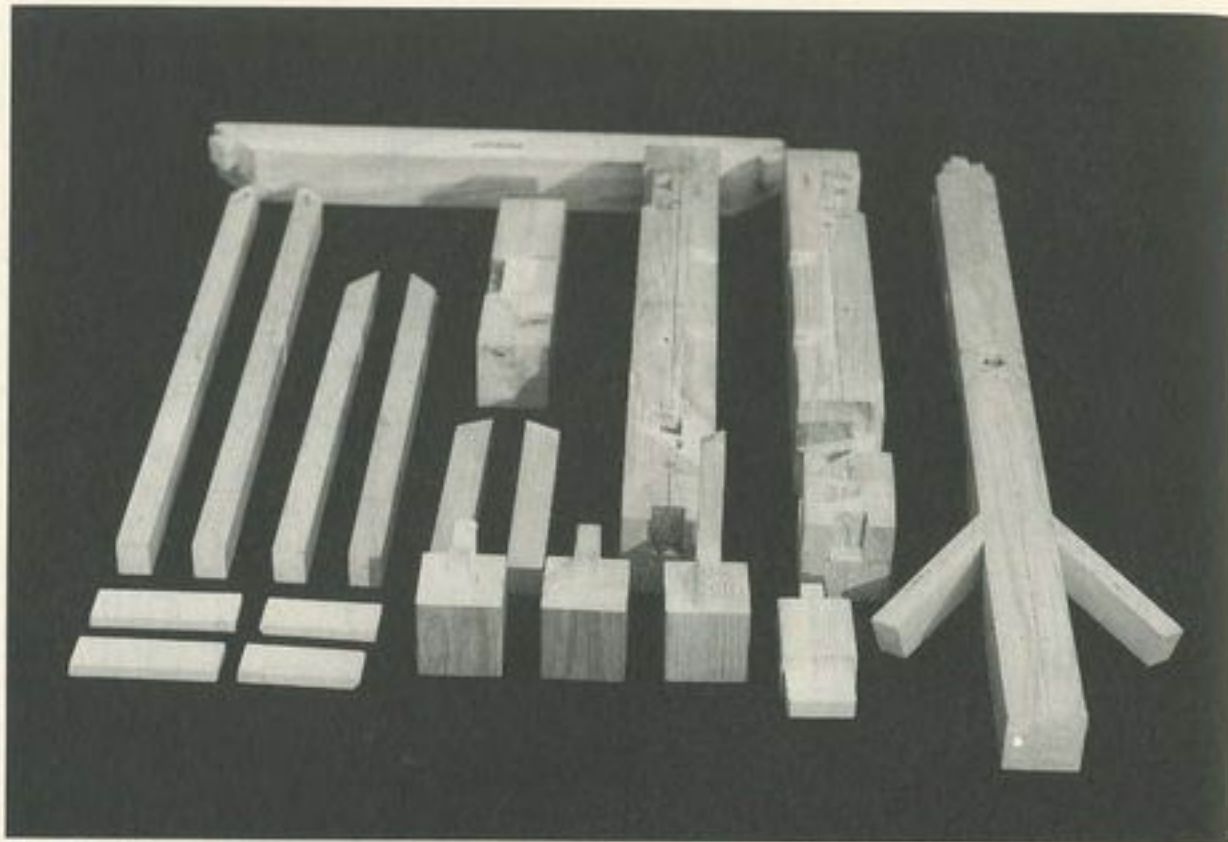

Top: Angle brace, center from left to right: rafters, rafter column, girders A and B, hip rafter
Bottom: from left to right: Covering boards, columns, hip rafter post

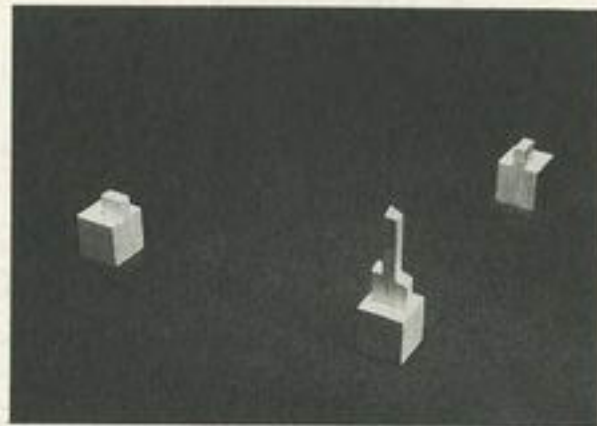

① Arrangement of the columns

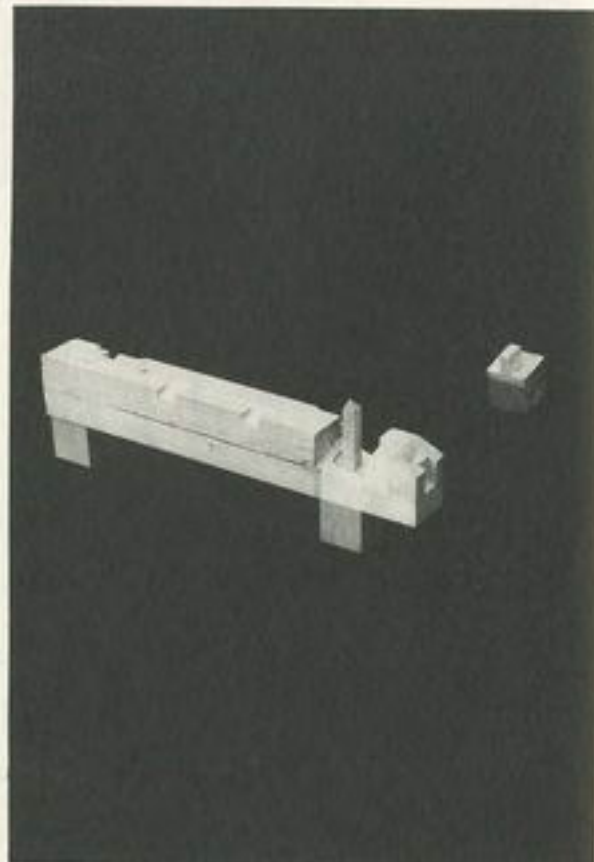

② Assembling the eave girders

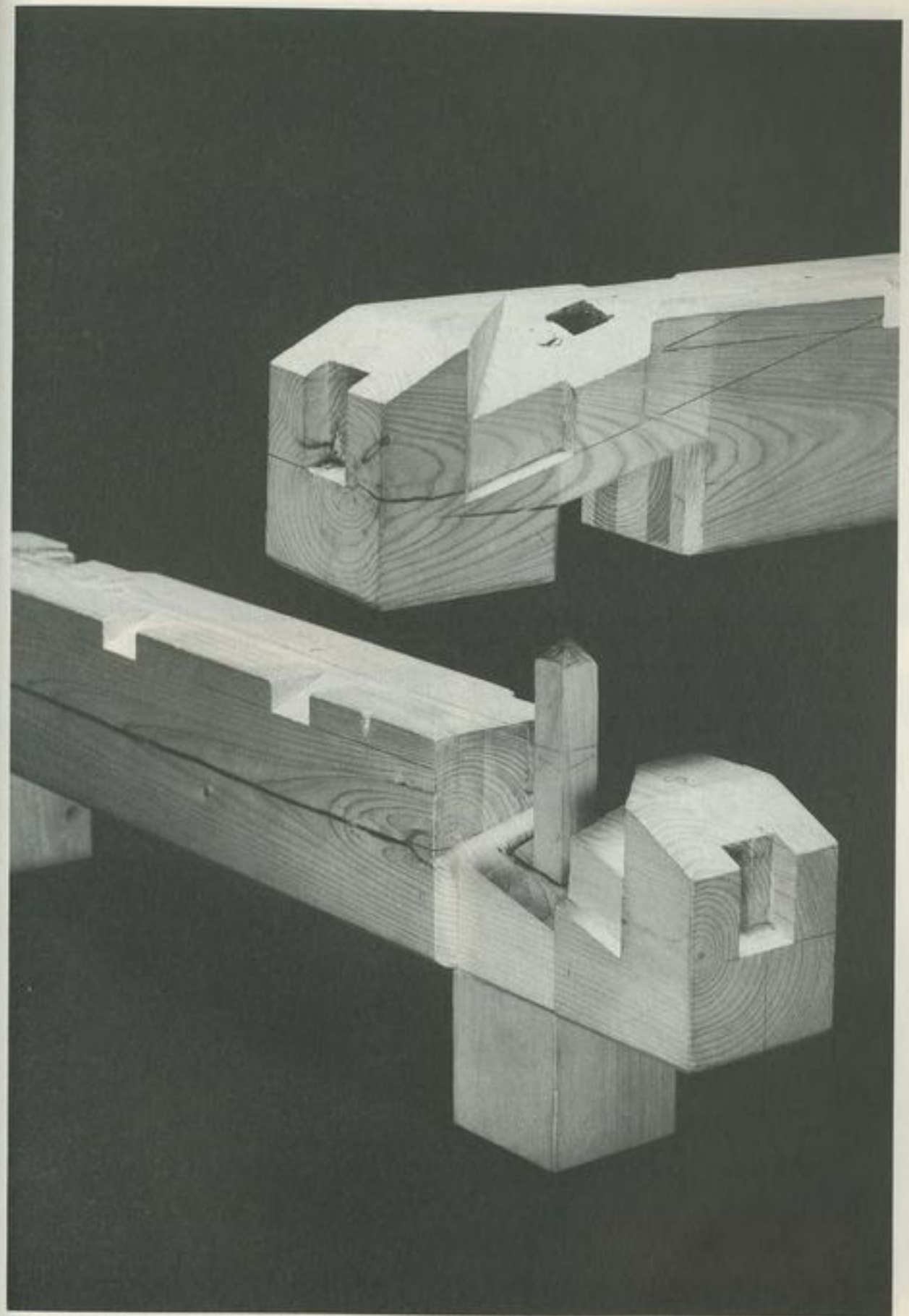

③ Assembling the eave girders (the stepped tenon of the corner column extends beyond the girders to the top surface of the hip rafter)

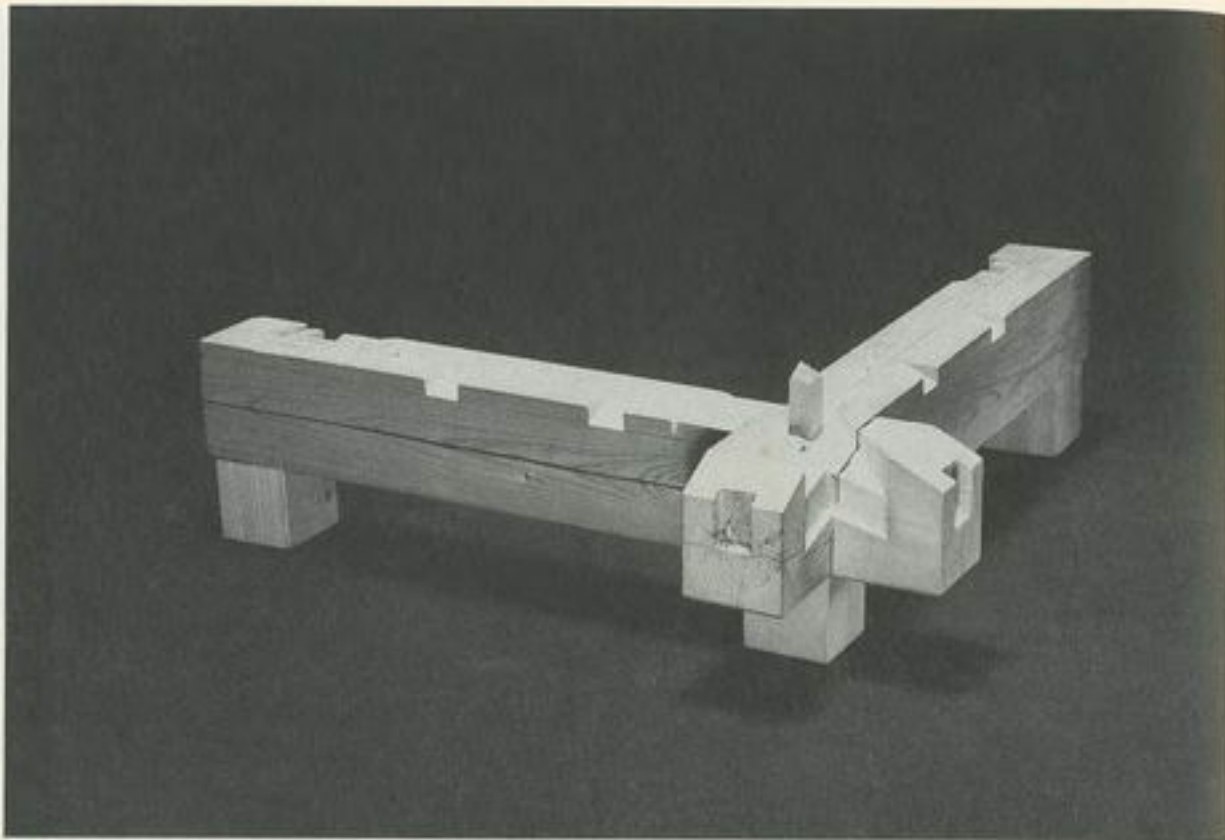

4 The bevelled halving joint is completed.

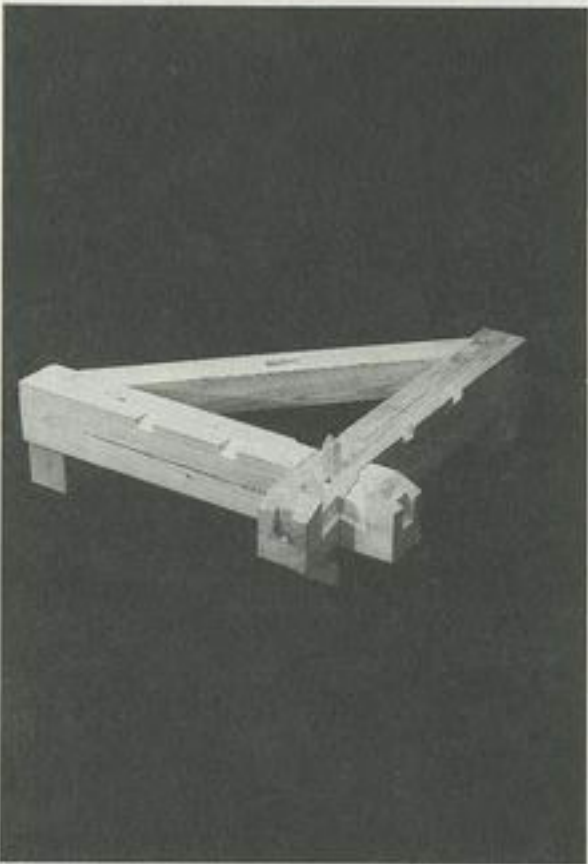

5 The angle brace is set in place.

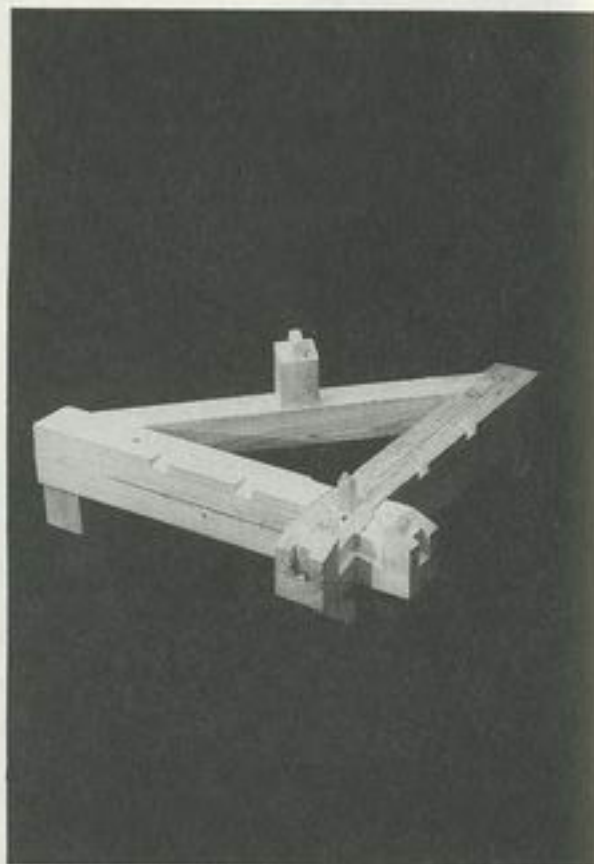

6 Installing a short post to support the hip rafter (necessary for this system).

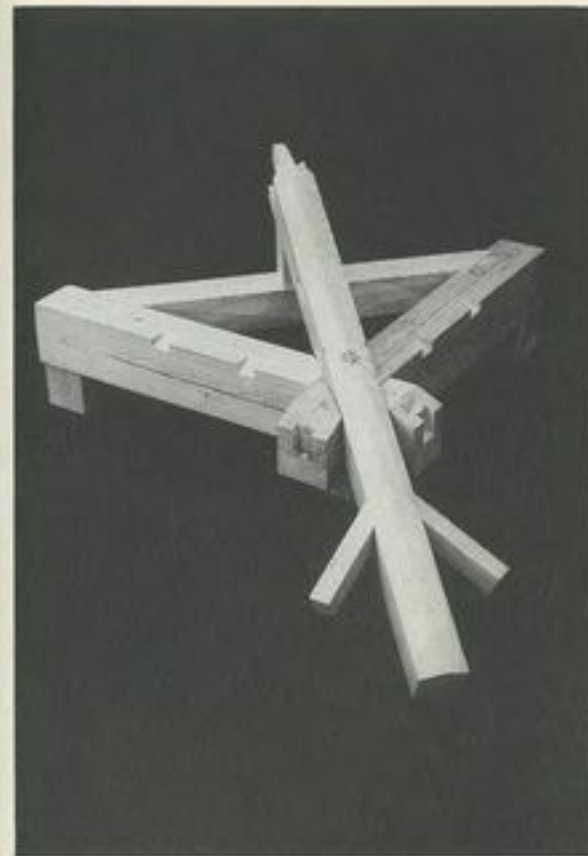

7 The corner rafter is fixed.

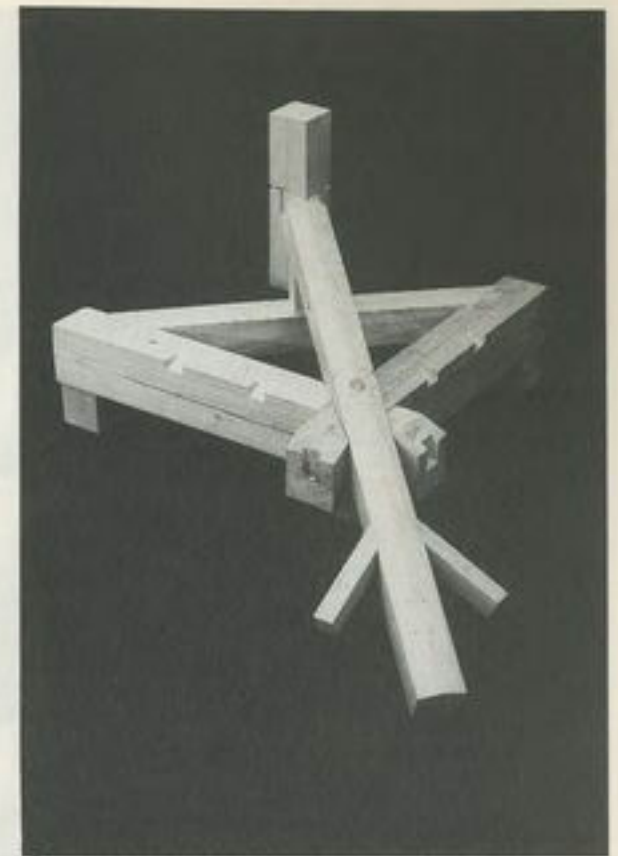

8 The rafter column is connected to the hip rafter.

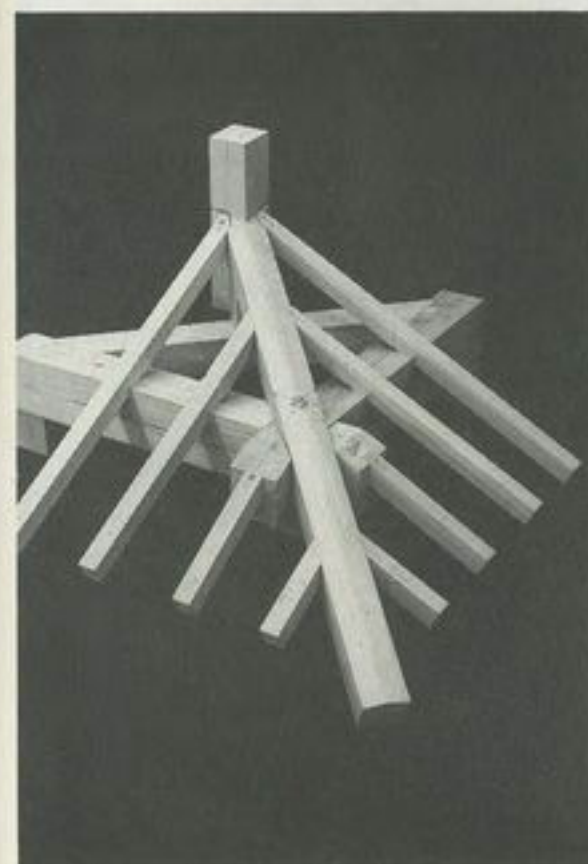

9 The roof rafters are set.



10 The covering boards are on.

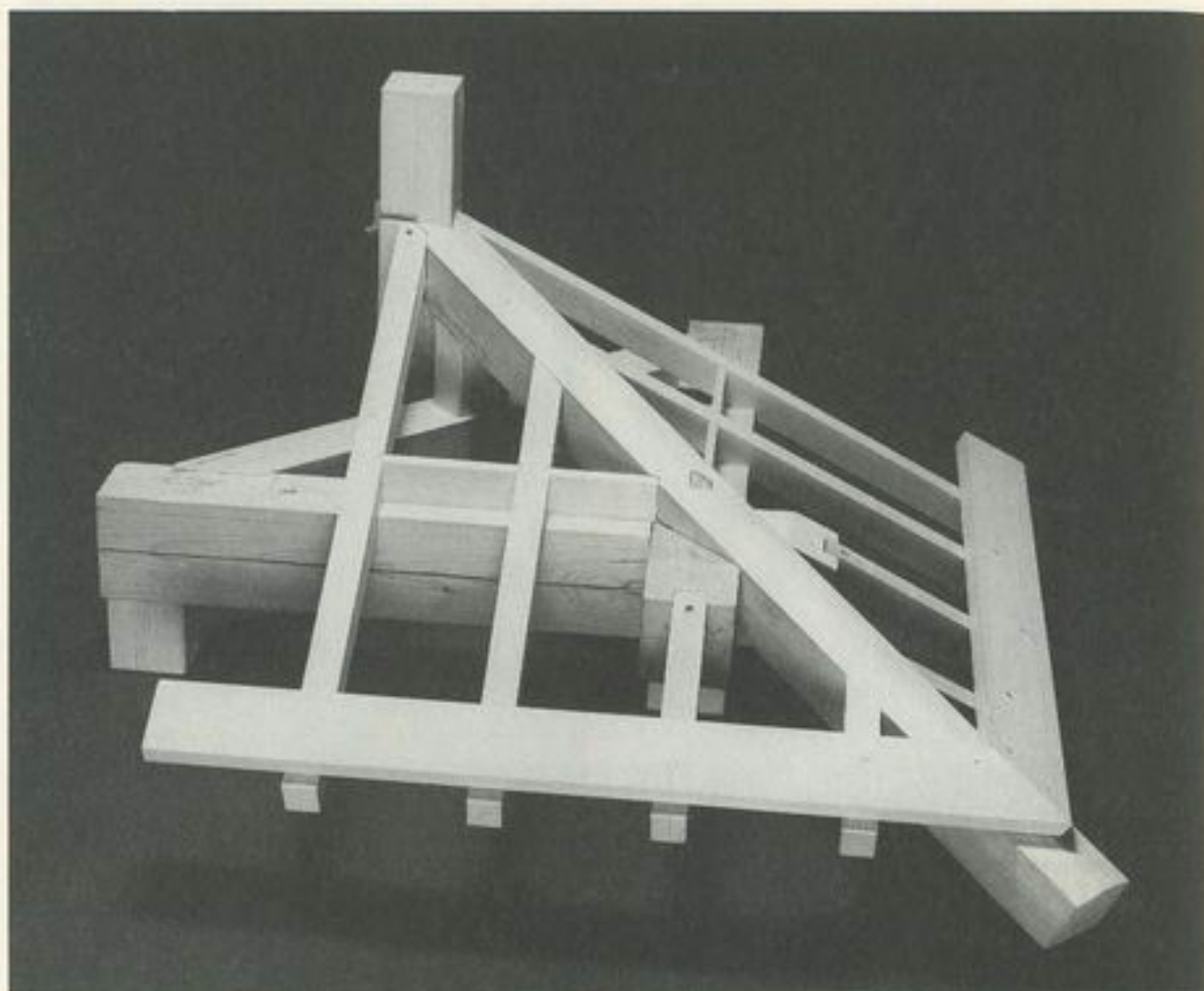

① The eave's boards complete the structure.

● CONNECTING JOINT 13 ●

Corridor girder

(Engawa no keta)

This is a more complex joint than the previous hip corner joints. The structure is composed of two log girders, joined in a Tee-shape and of a log girder nose. The girder nose (B-1) gives the assembly a balanced look. The shorter girder (B-2) seems to form a single continuous member with the girder nose. To accentuate this effect the nose (B-1) and the short girder (B-2) are cut out of the same piece of wood. This assemblage is extremely complex. First the nose (B-1) is inserted into girder A. After the tenon has gone through, the nose is rotated at 90 degrees and pushed toward A in its final position. Afterward, the short girder B-2 is assembled onto girders A and B-1.

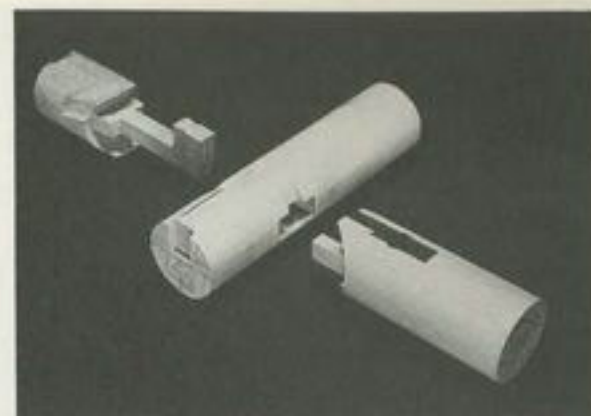

① Arrangement of the log girders. From left to right: girder nose (B-1), long girder (A), short girder (B-2)

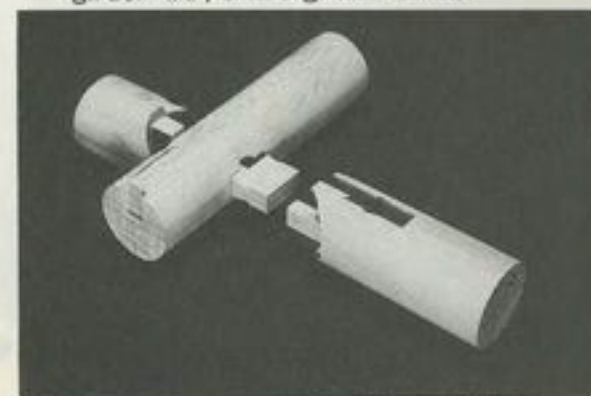

② The girder nose's (B-1) tenon is inserted into girder (A) in a horizontal position.

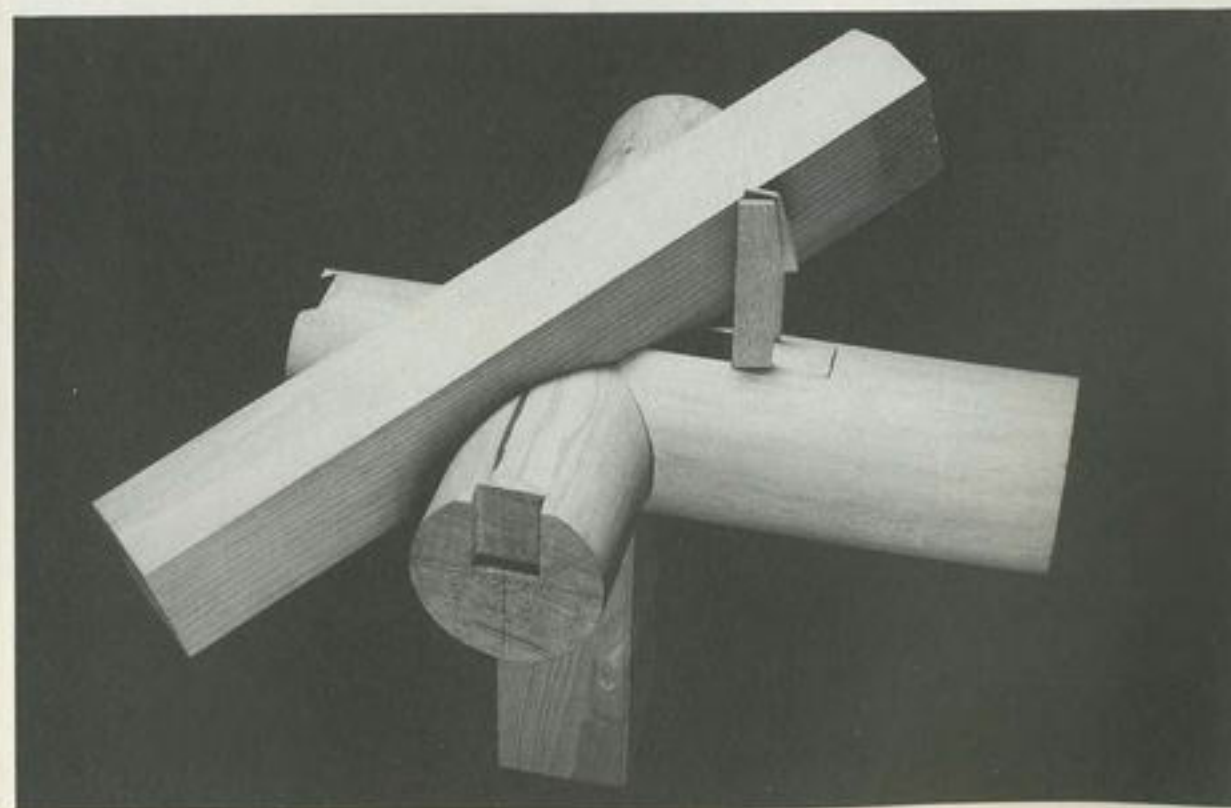

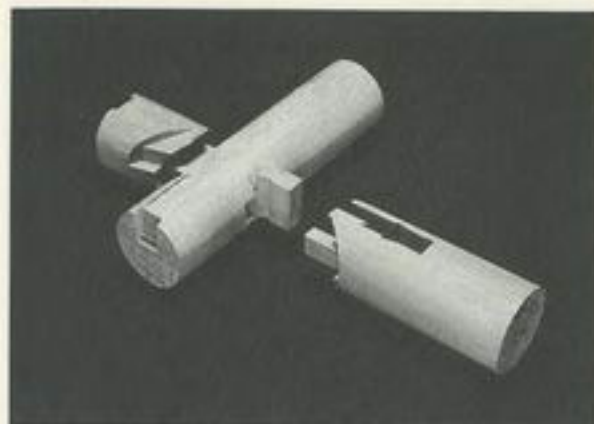

③ The girder nose (B-1) is rotated at 90 degrees from its previous position.

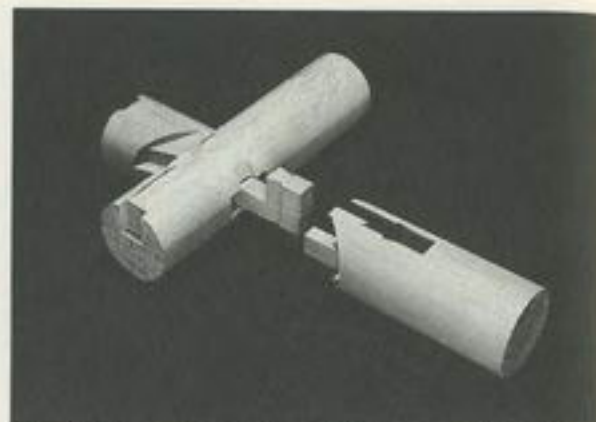

④ After rotation the girder nose (B-1) is pressed forward into girder (A).



⑤ The girder nose's (B-1) tenon is inserted into girder (B-2).

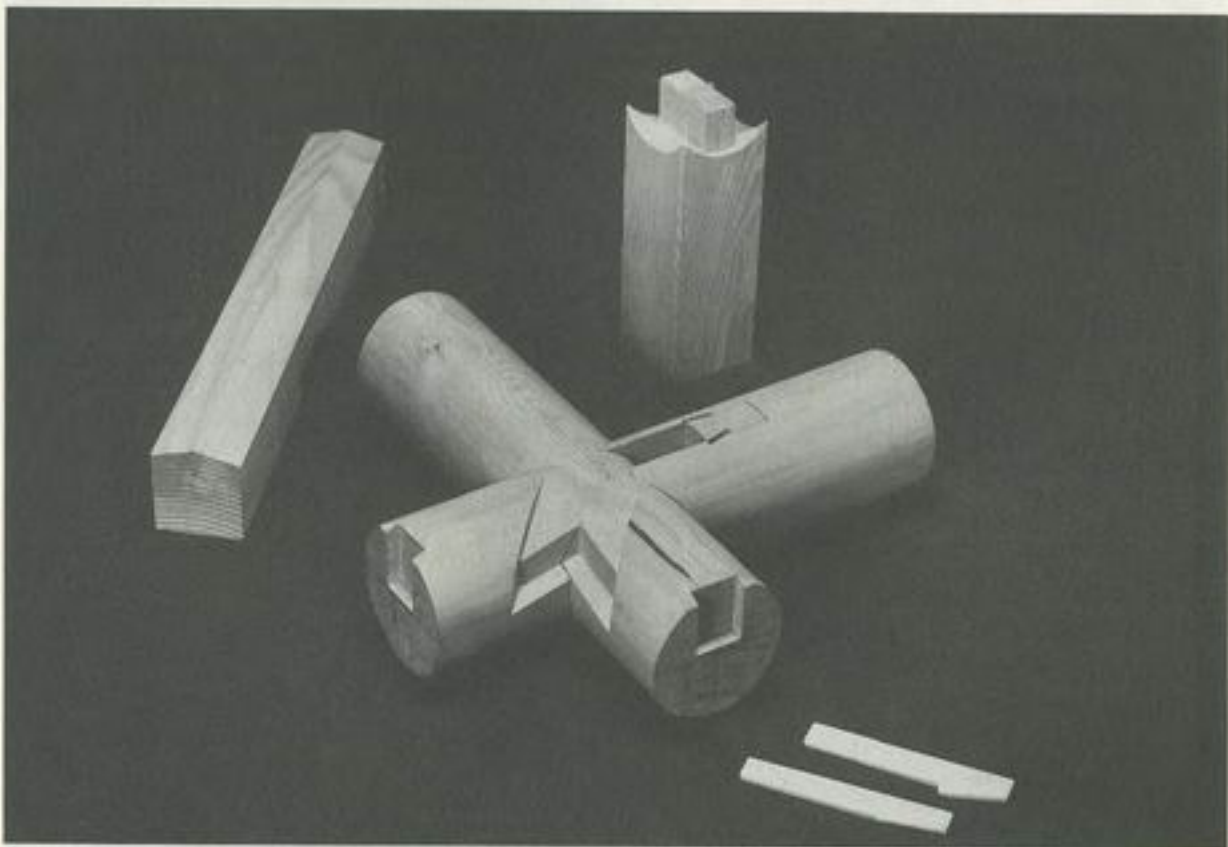

⑥ Log girders with the hip rafter and column before inserting the draw pins.

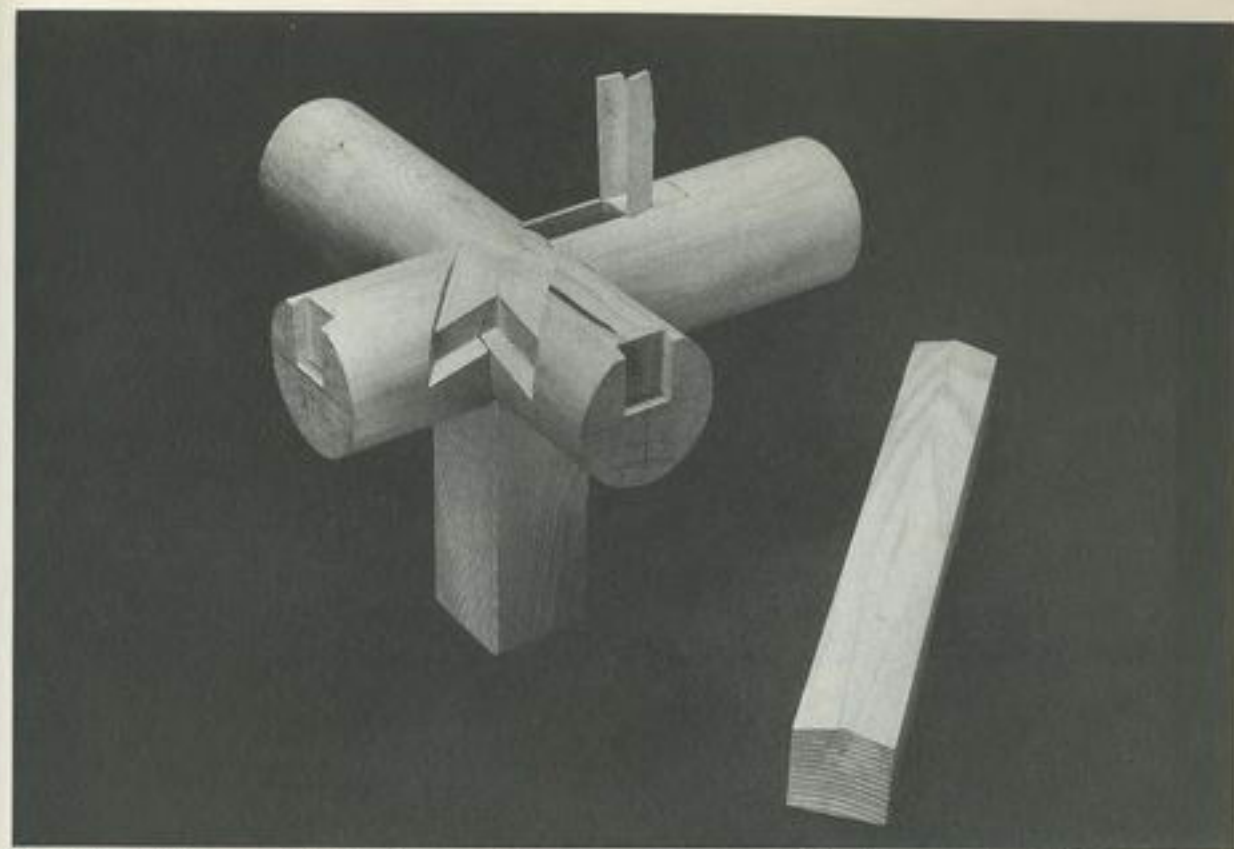

⑦ The girders are installed on top the corner column and the keys are inserted.

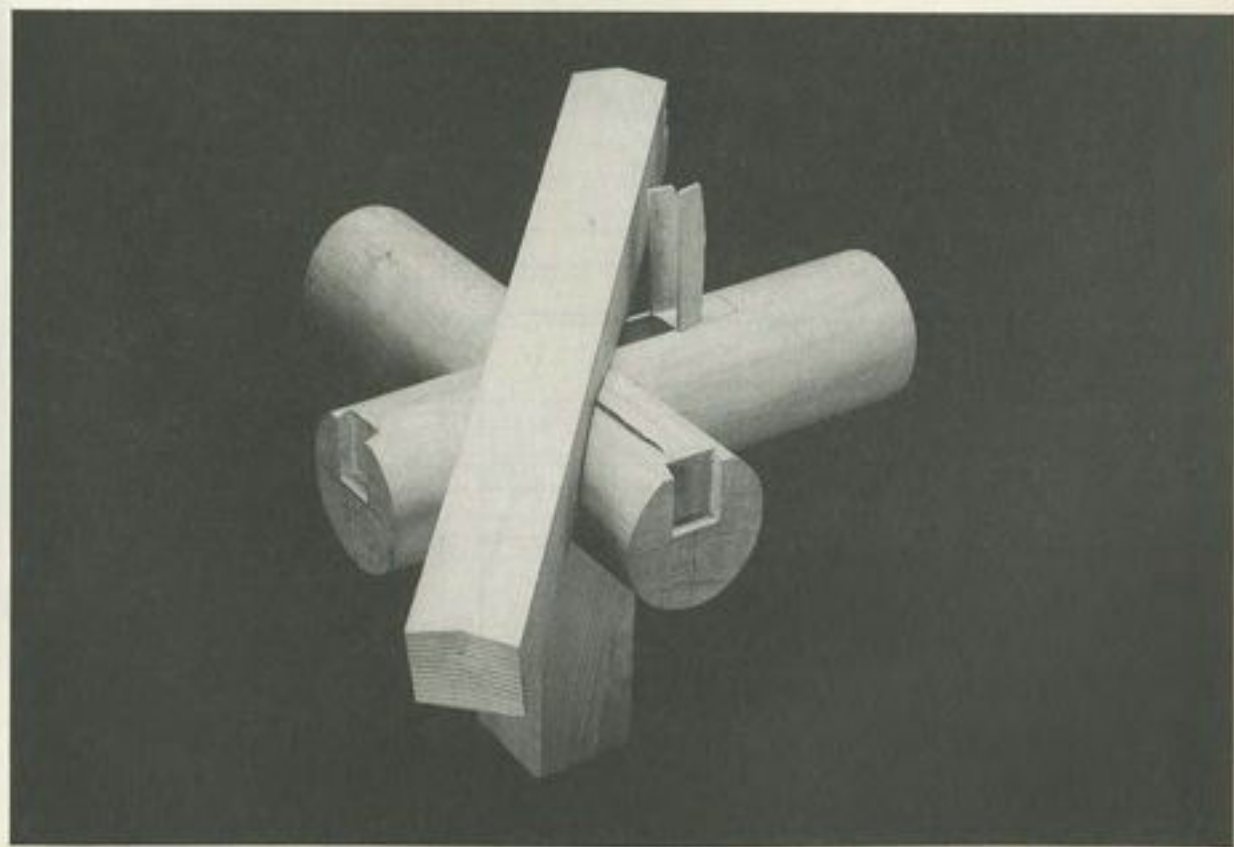

⑧ The hip rafter completes the assembly. It is not necessary to fill the gap in girder B-2 with a plug.

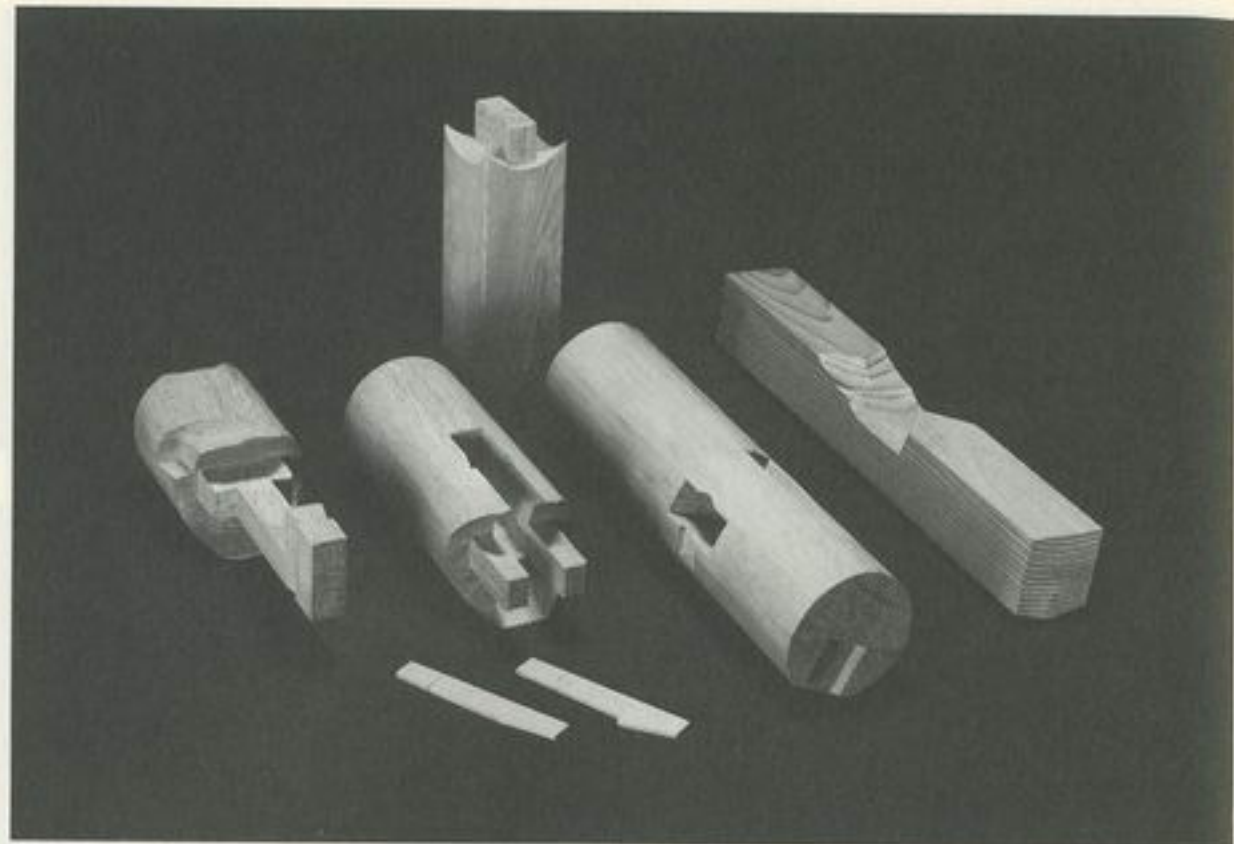

Top: corner column. Bottom from left to right: Girder nose B-1, short girder B-2, long girder A, hip rafter

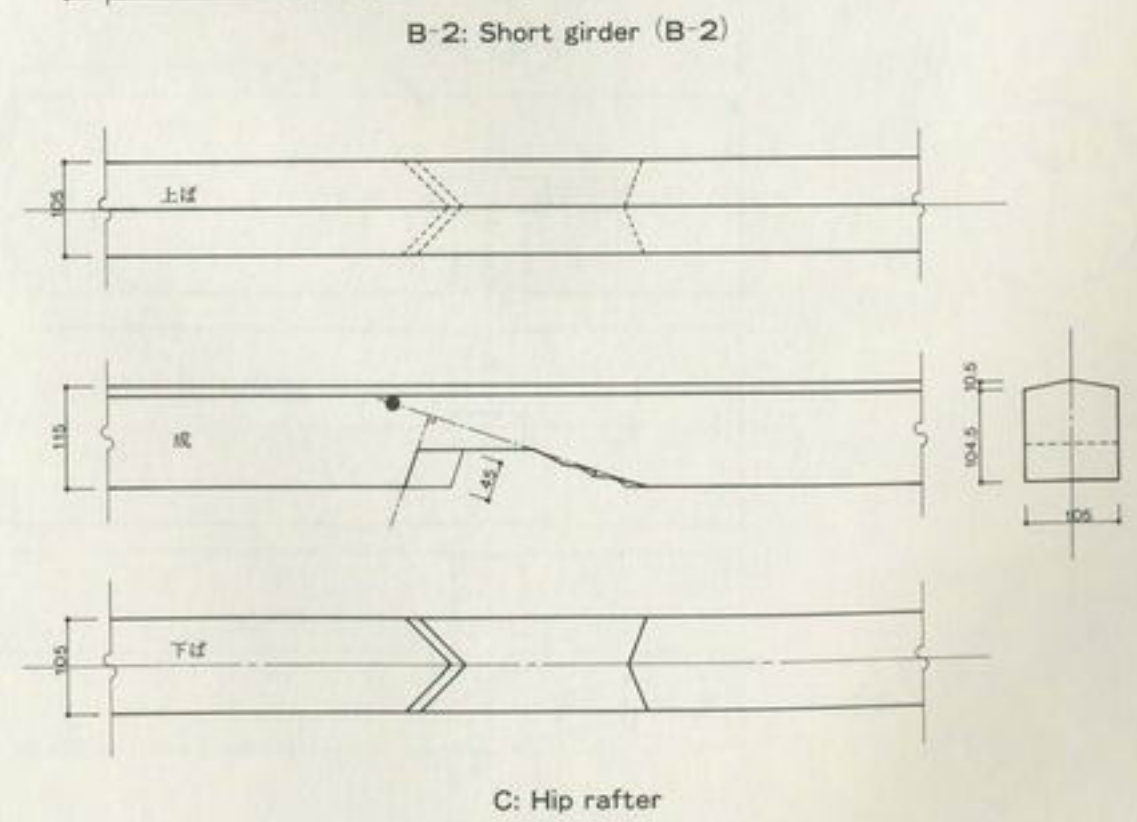
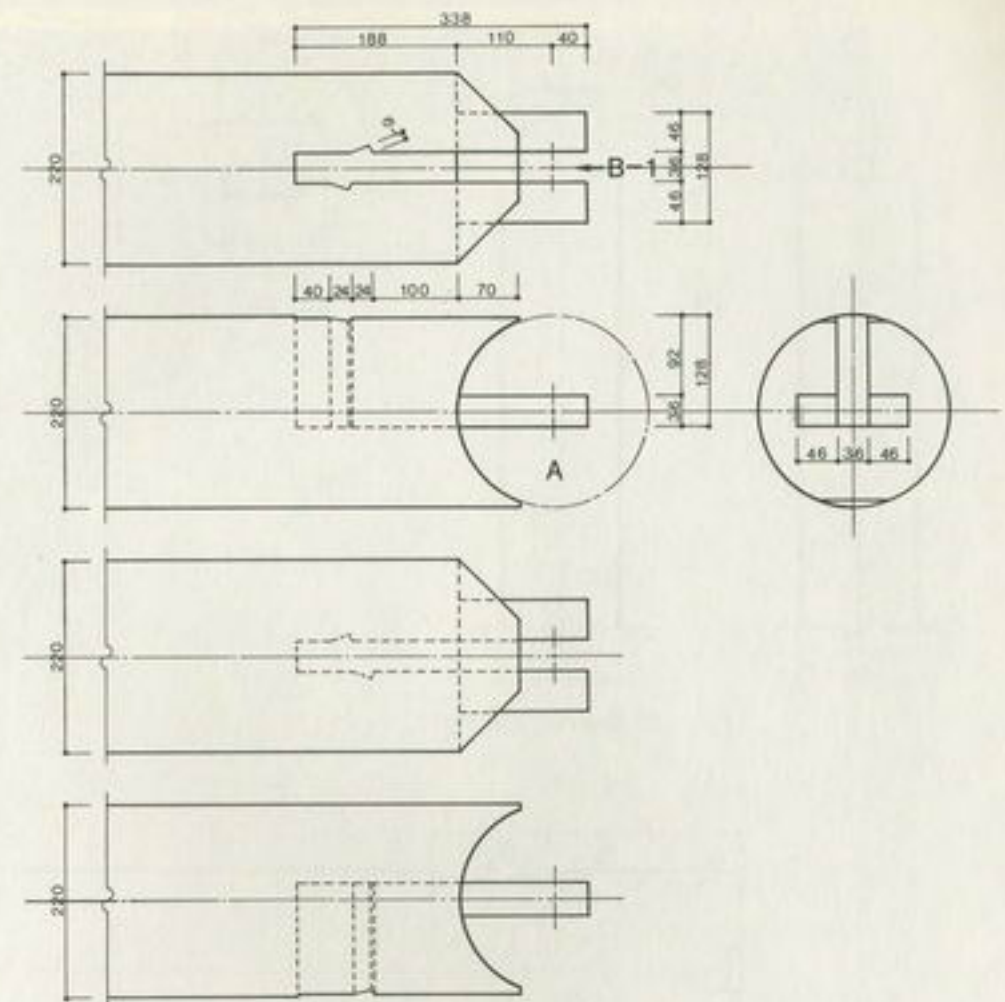
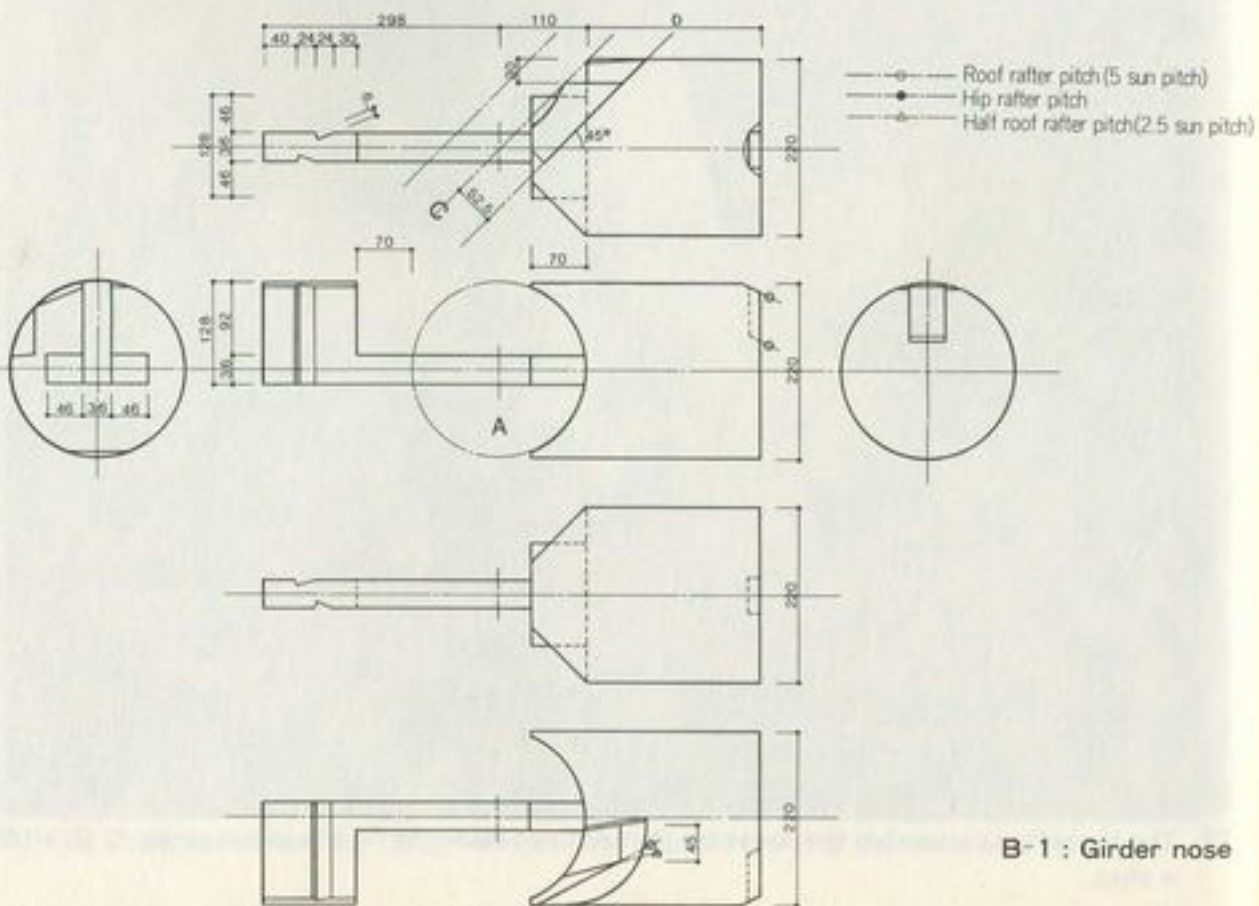

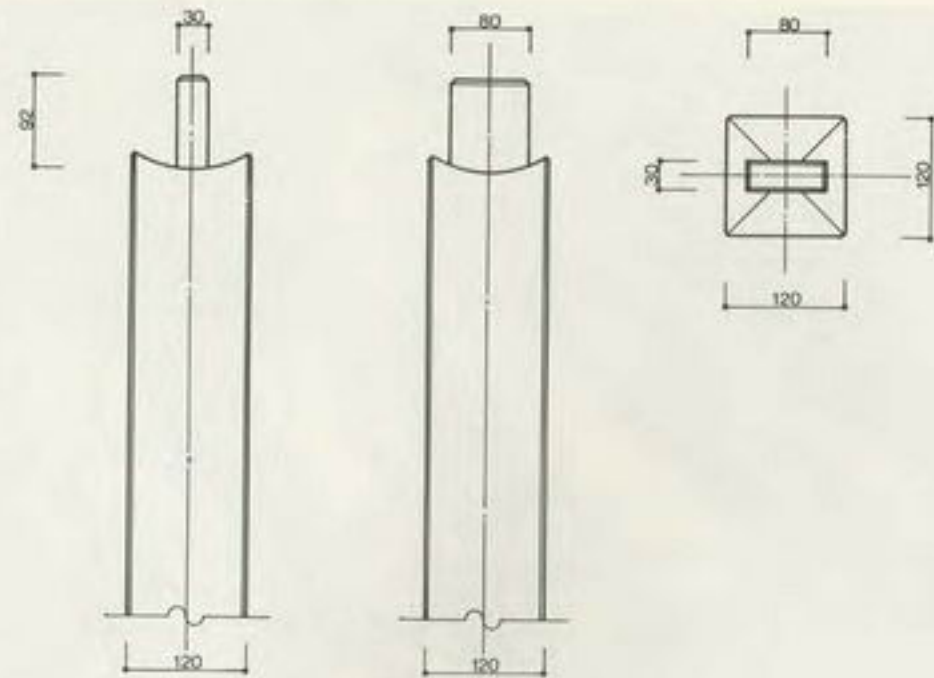

D: Corner column

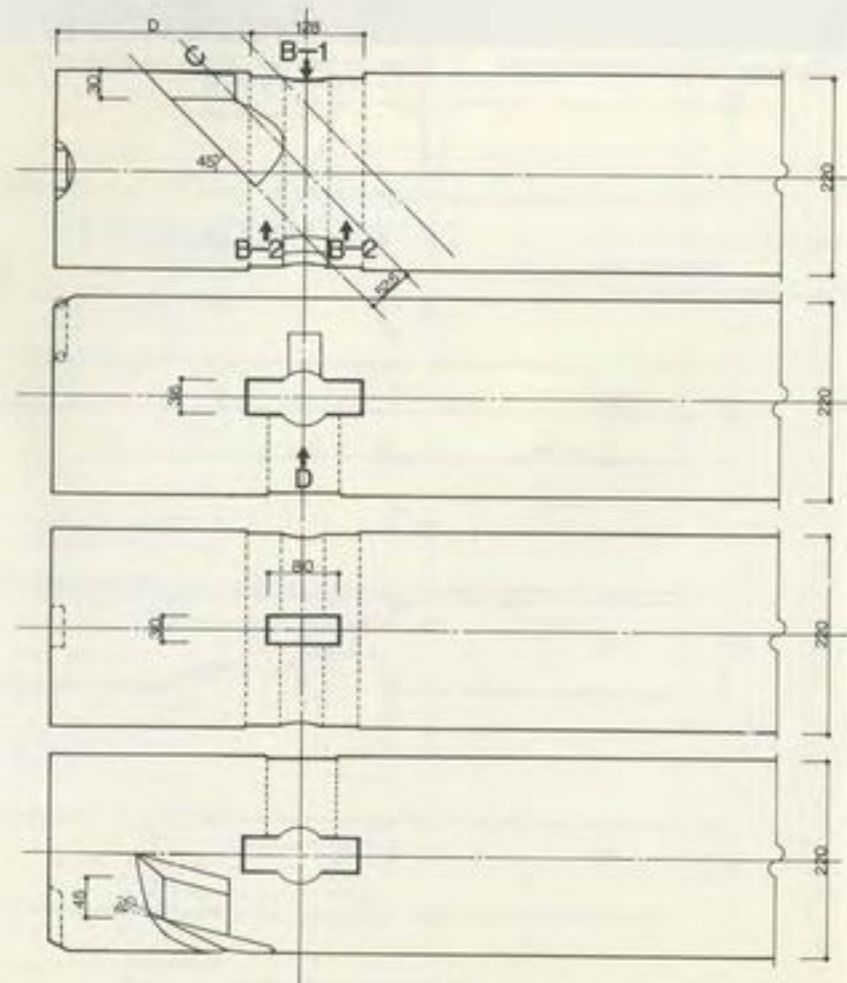
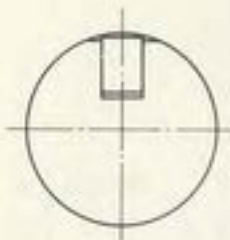

A: Long girder (A)

MISCELLANEOUS

● MISCELLANEOUS 01 ●

Gable board

The gable board is used to cover the ends of purlins and girders. The joint connecting the two sloping board is called "ogami", which means praying with hands clapped together. Three ways of making an

"ogami" are shown. The gable boards are not fixed vertically to the ends of the purlins. Aesthetical considerations determine the angle at which they are fixed. The "ogami" joint is the weakest part of the gable board, consequently when exposed to loading a gap may open at the bottom. To avoid this occurrence methods 1) and 2) are preferred.

(1) Ogami with encased crossbrace

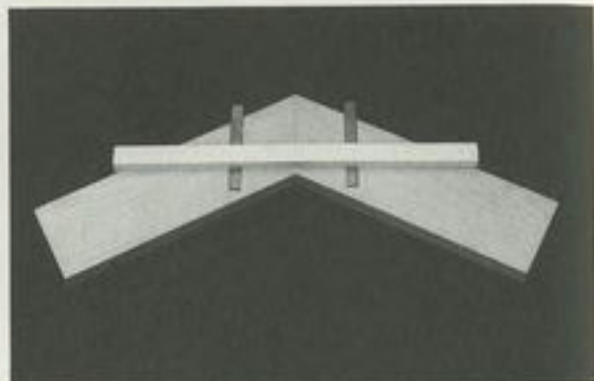
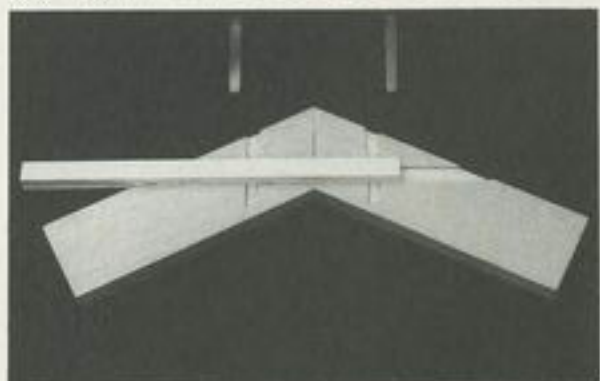

① The crossbrace is inserted onto the gable board.

② Two pins lock the crossbrace in place.

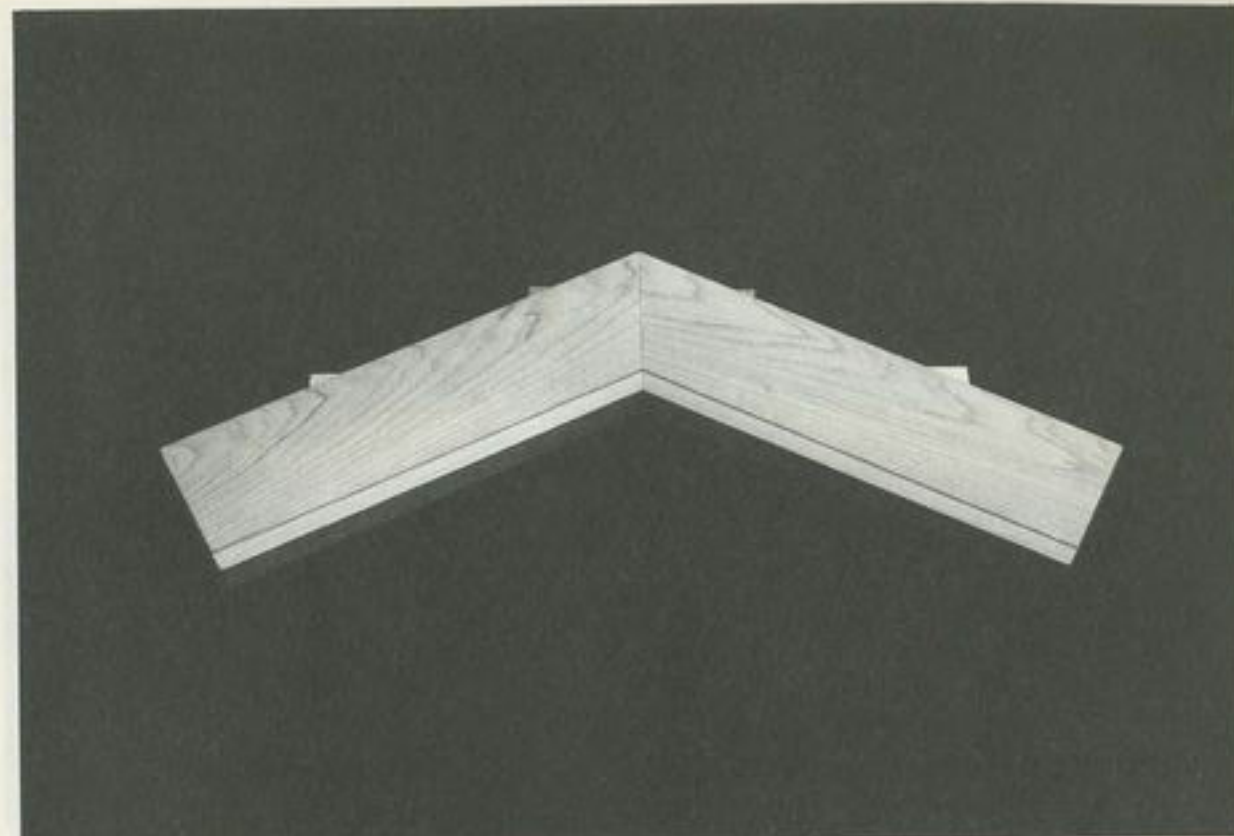
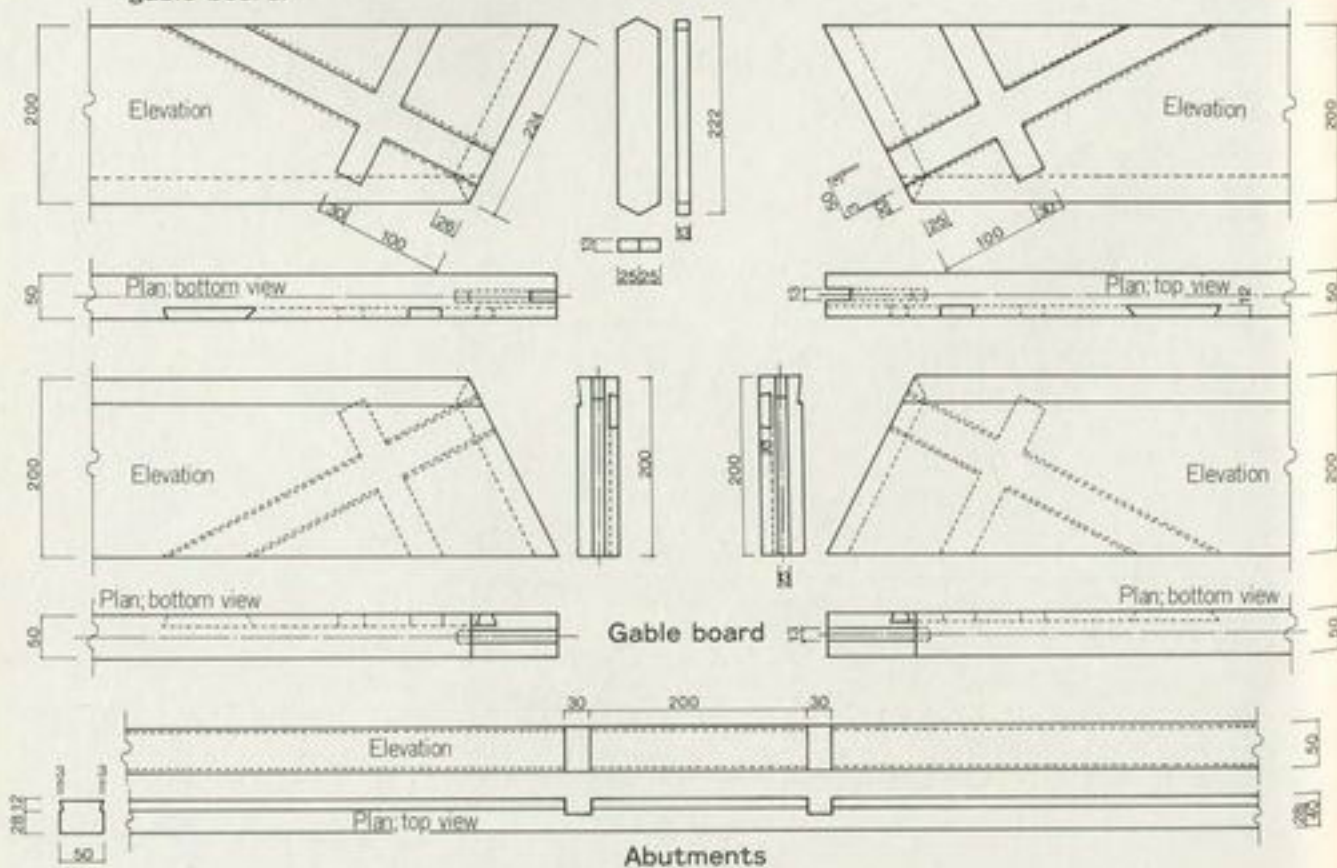

Exposed surface after completion

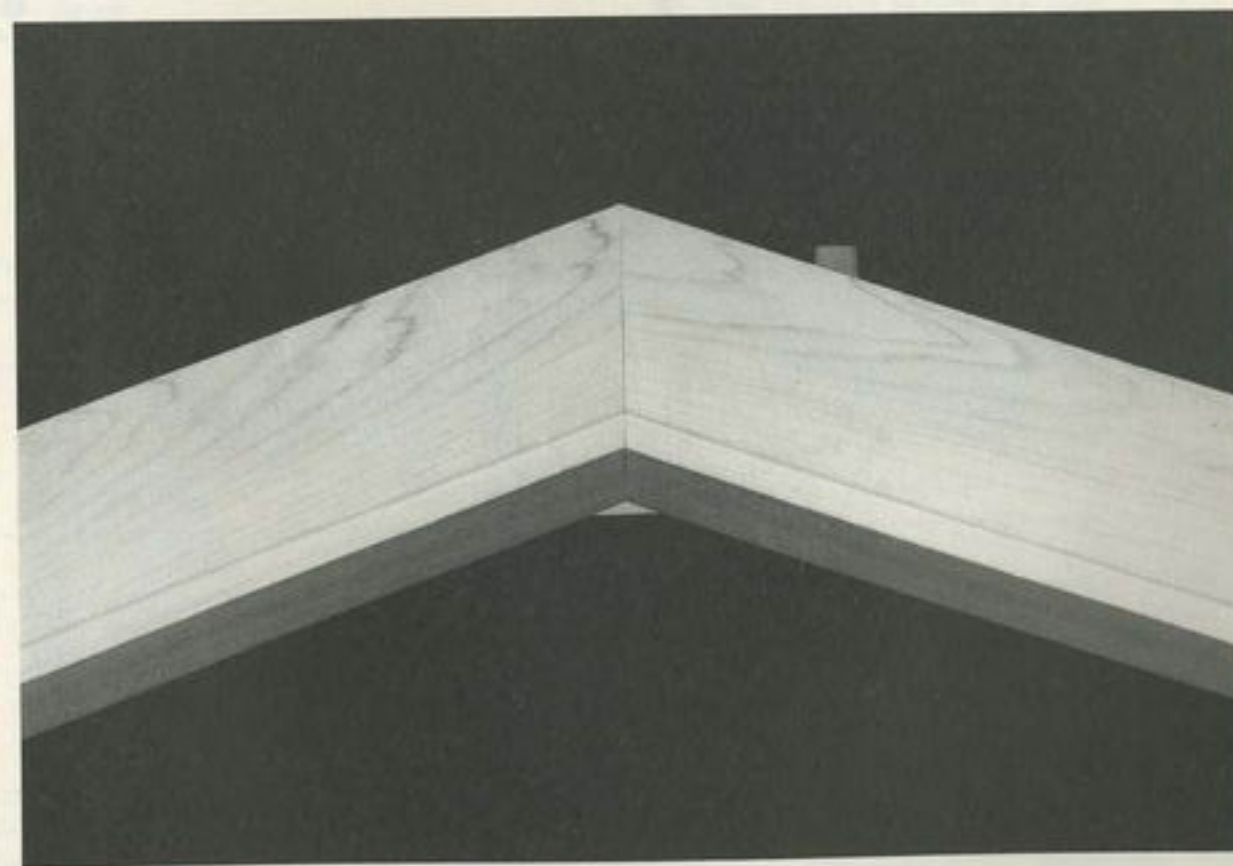

(2) Ogami with surface crossbrace

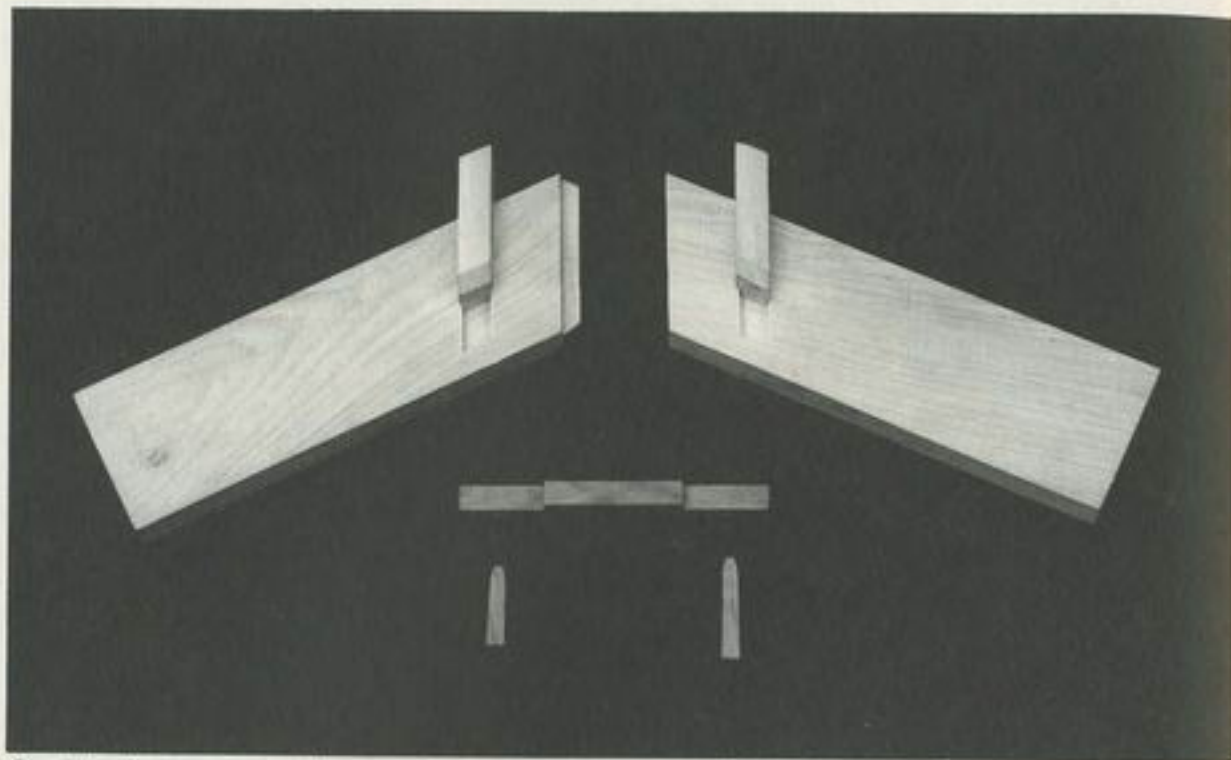

1 The abutments are inserted onto the gable board (from top to bottom: Abutments, gable board, crossbrace, drawpins).

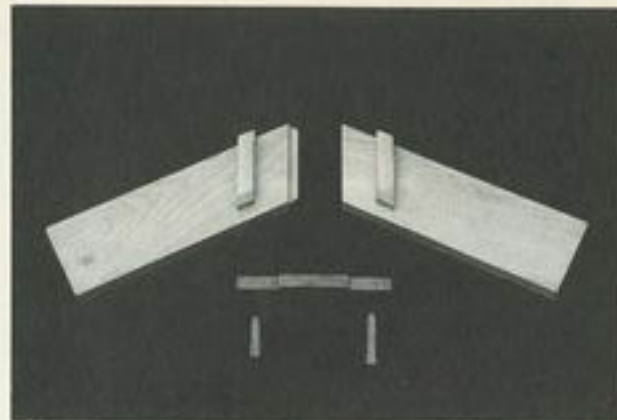
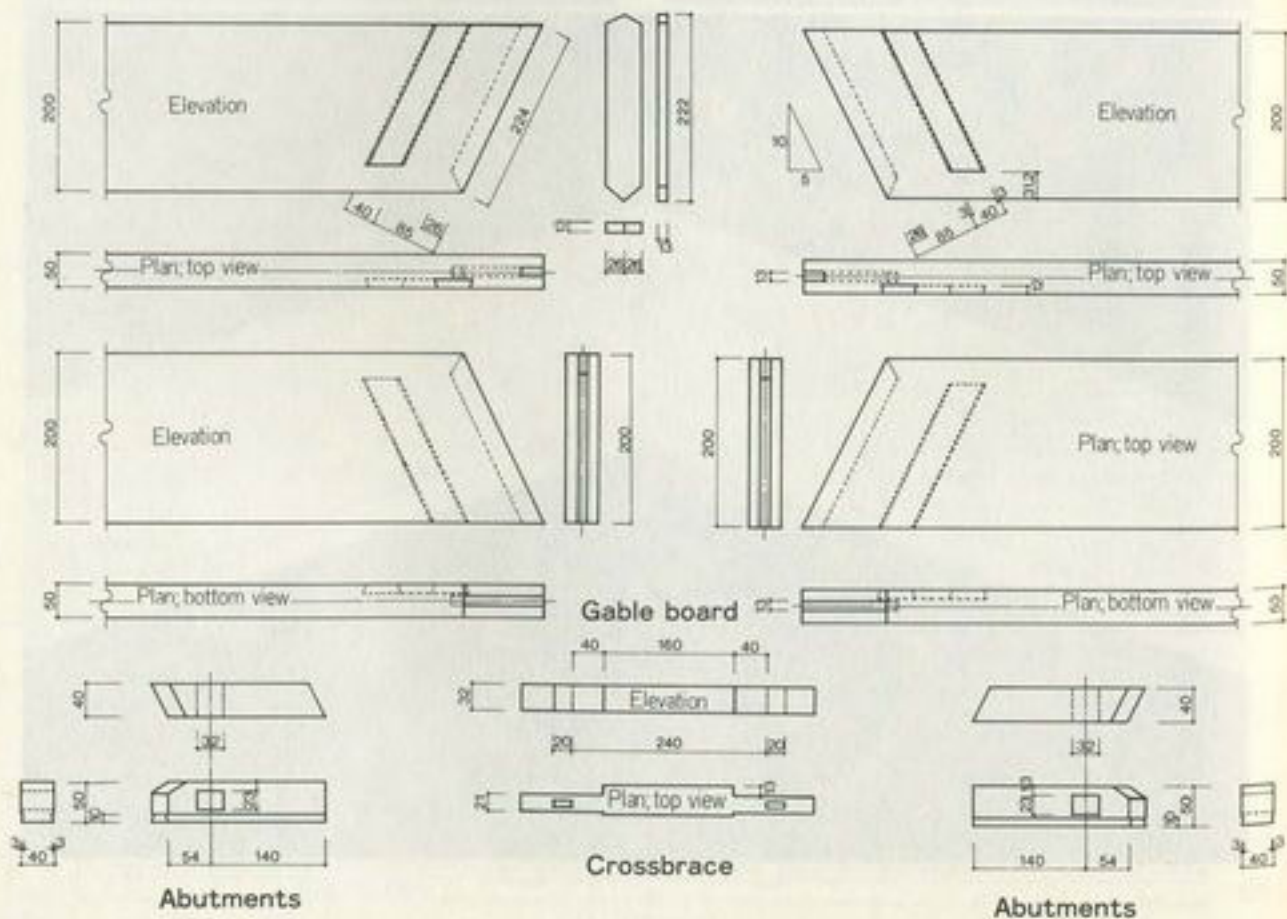

2 Same as picture 1

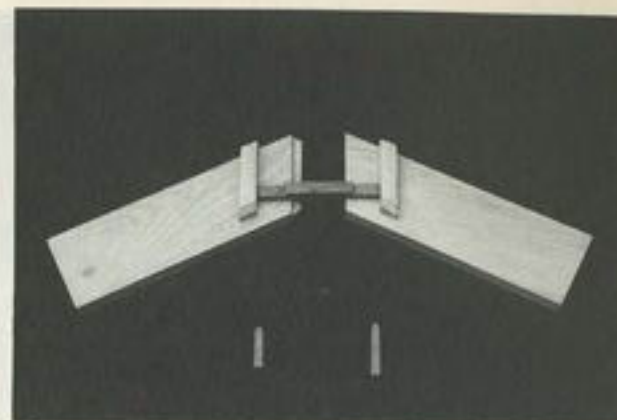

3 Inserting the crossbrace

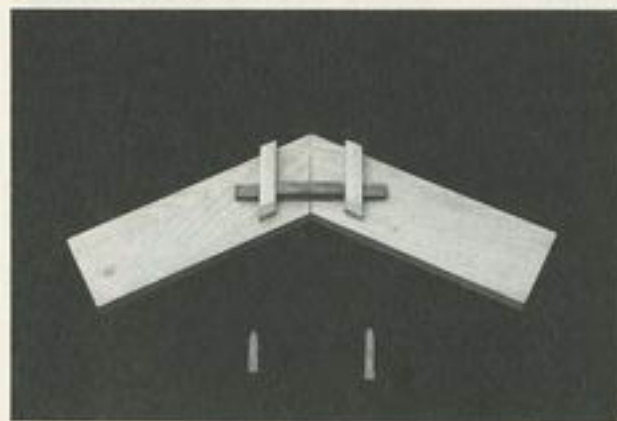

4 Same

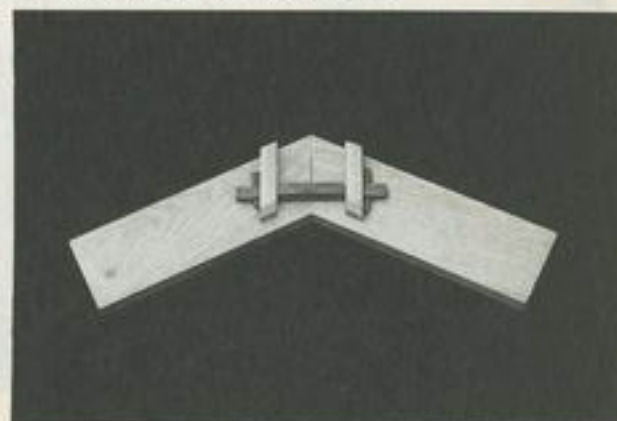

5 The drawpins secure the joint.

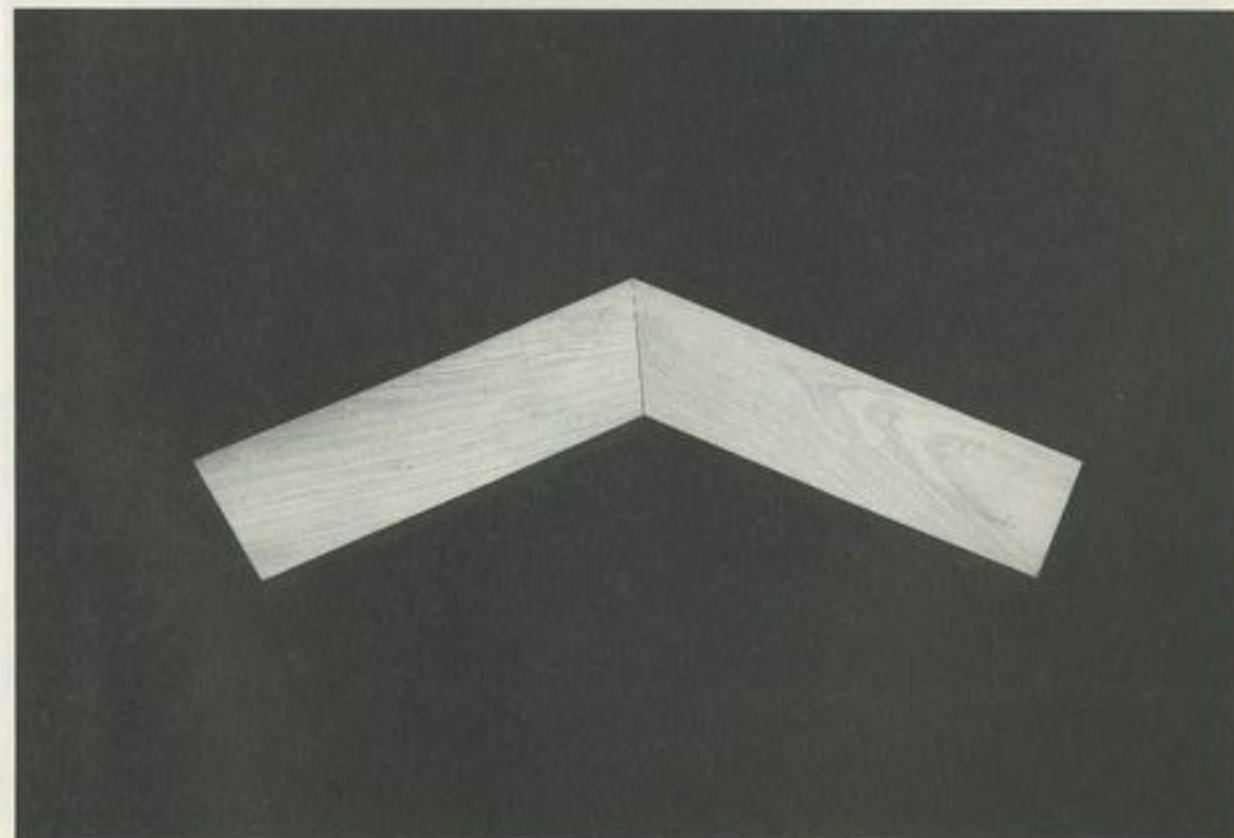

Exposed surface

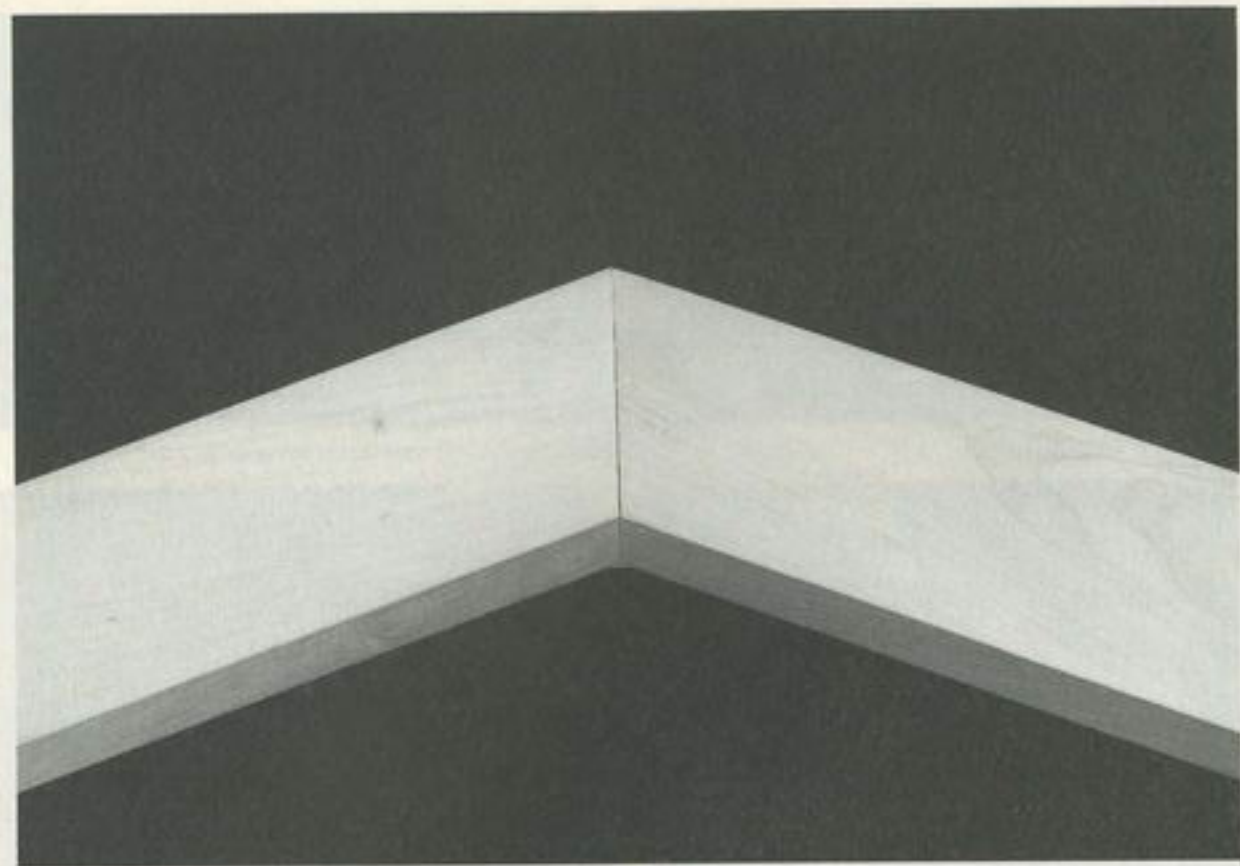

(3) Ogami with stub tenon and key

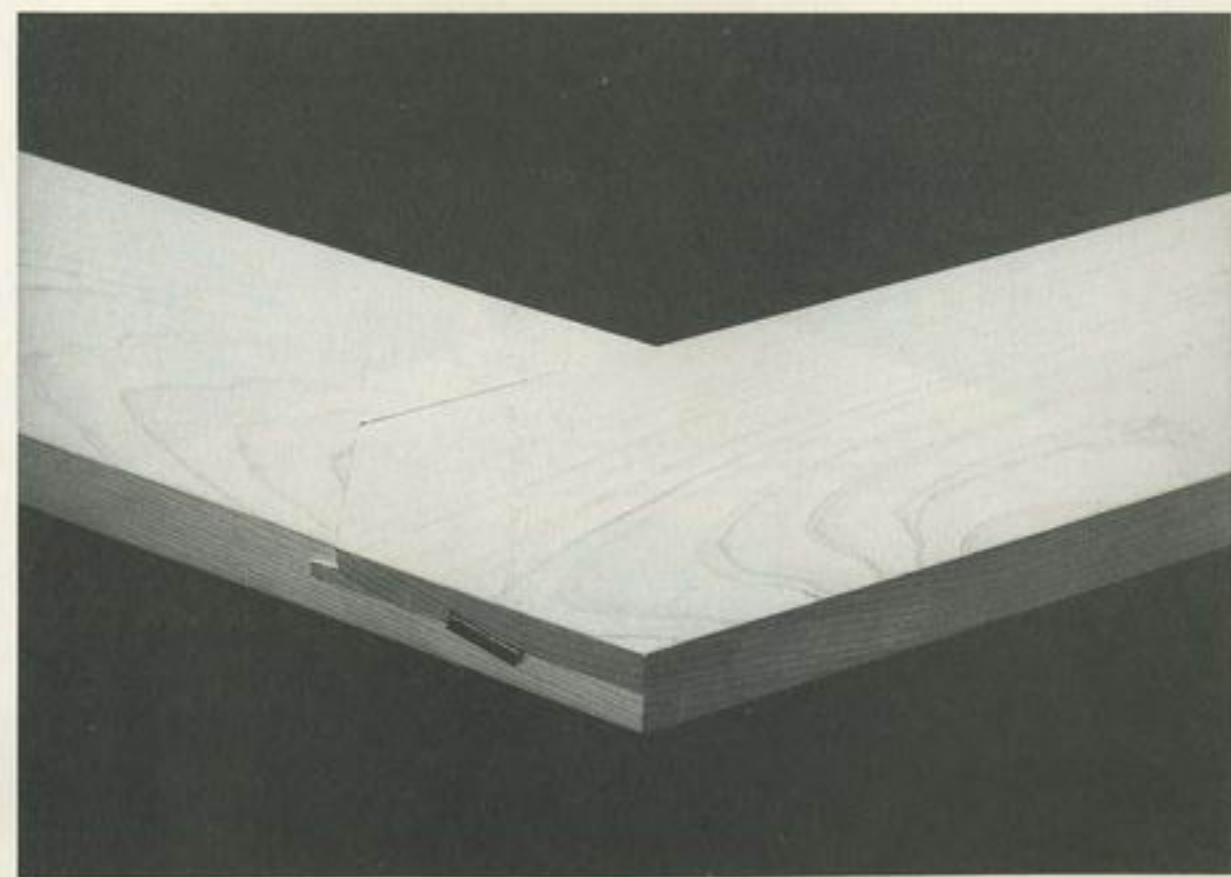
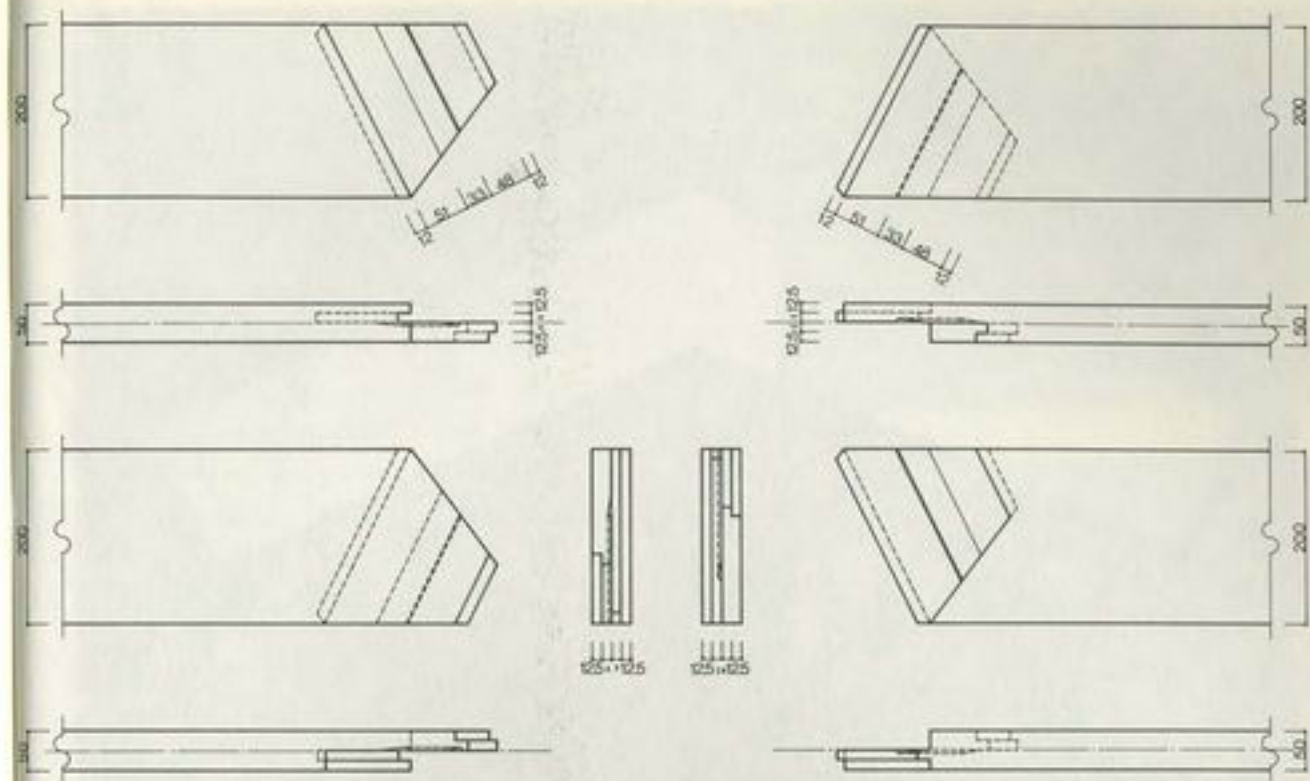
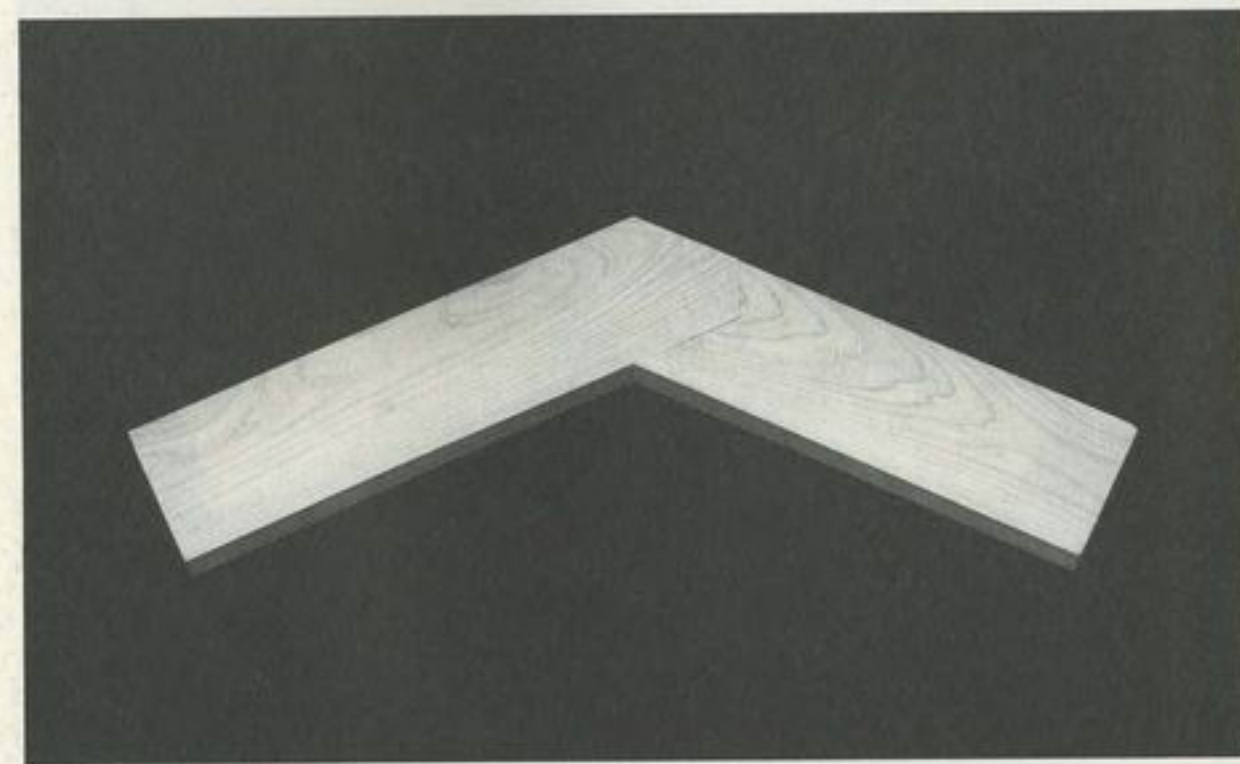

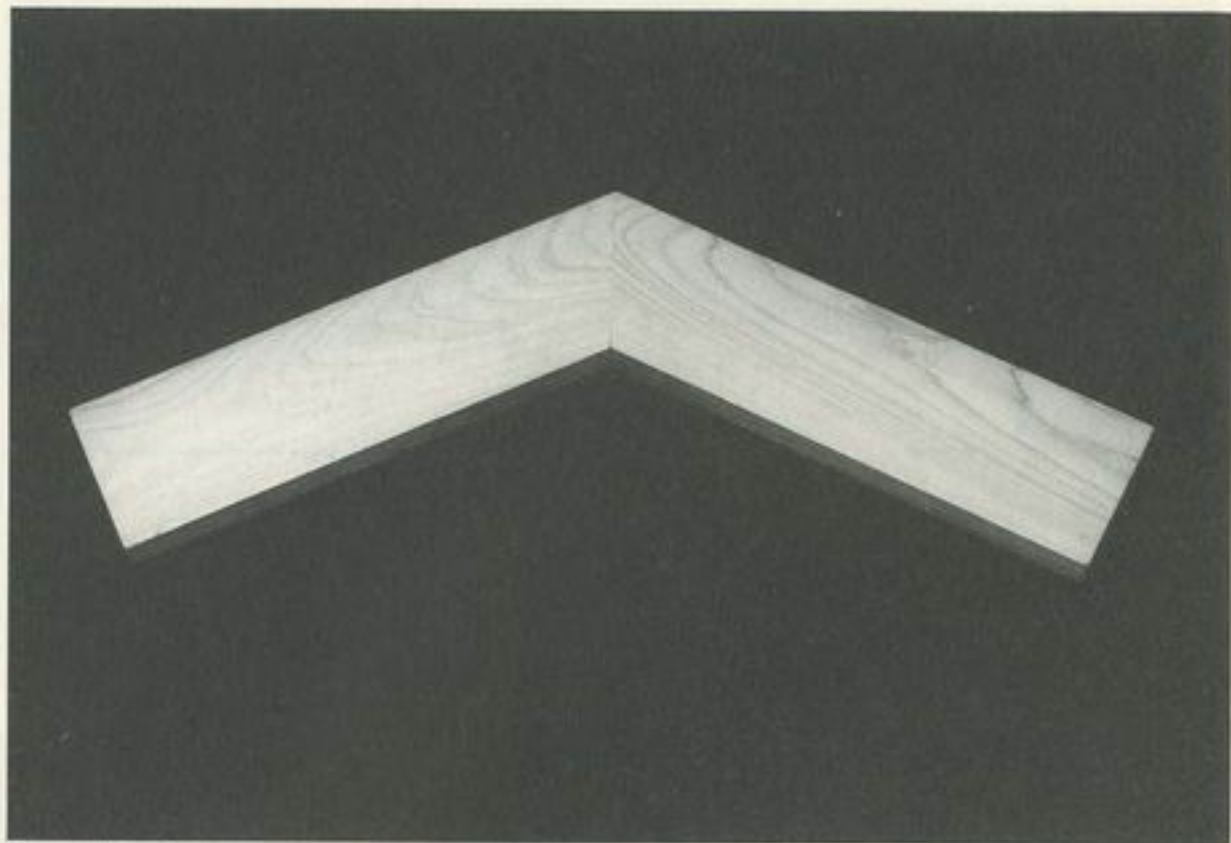

Exposed surface

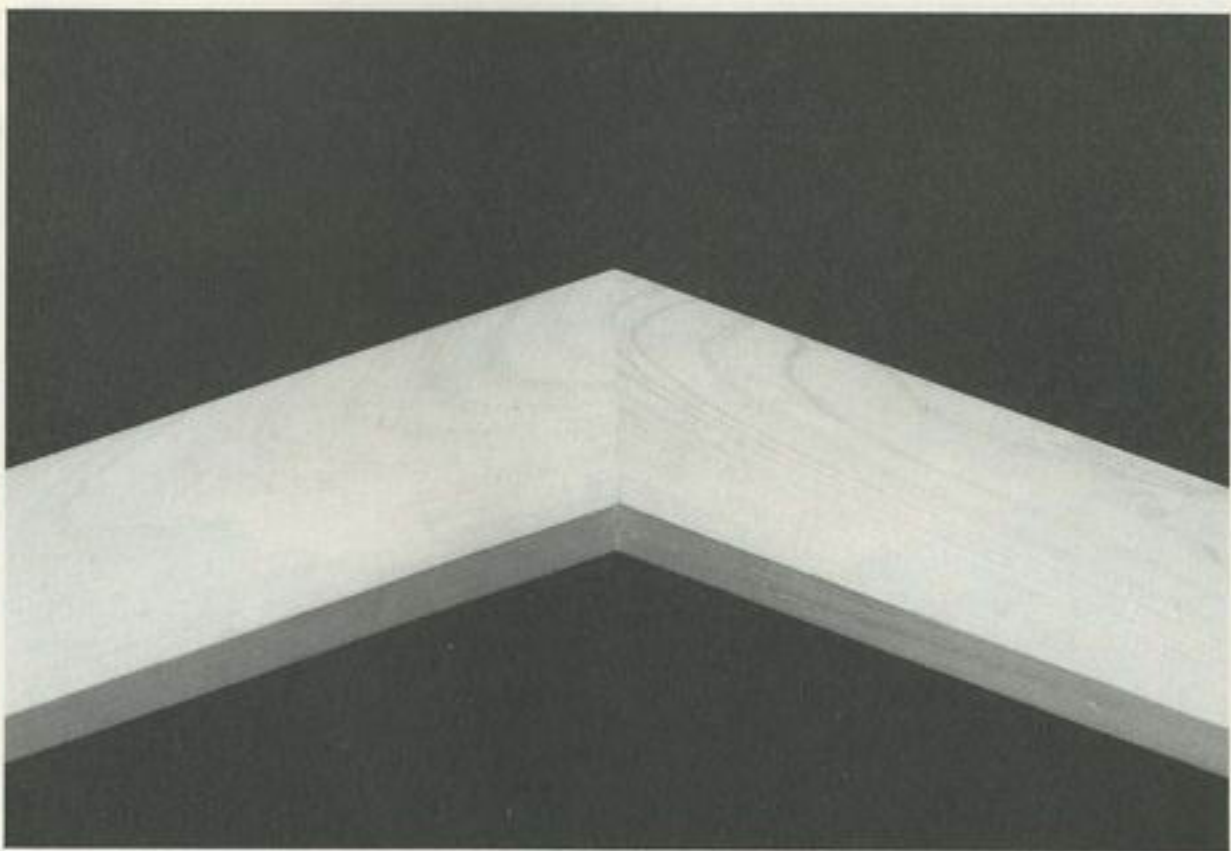

● MISCELLANEOUS 02 ●

Level

Traditional hand level. Longer levels give more accurate readings. The level is set on top of the surface to be measured. Water is poured into the middle cavity. The horizontal line is found when an equal quantity of water flows on either side down the slot. In general, the length of the level is two ken (six feet) and the cross section is 2×4 sun (one sun is one tenth of a foot). This hand level has been commonly used in conjugation with batter posts to set level references around an area.

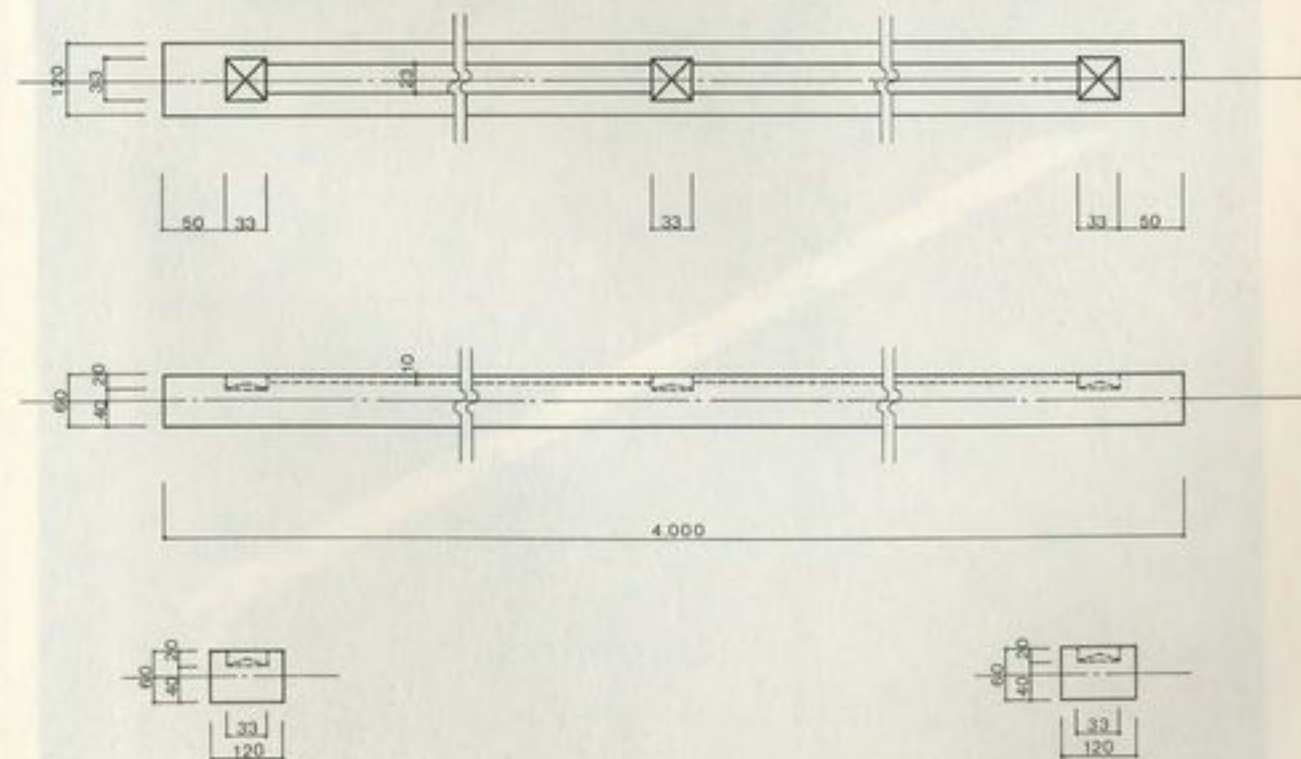
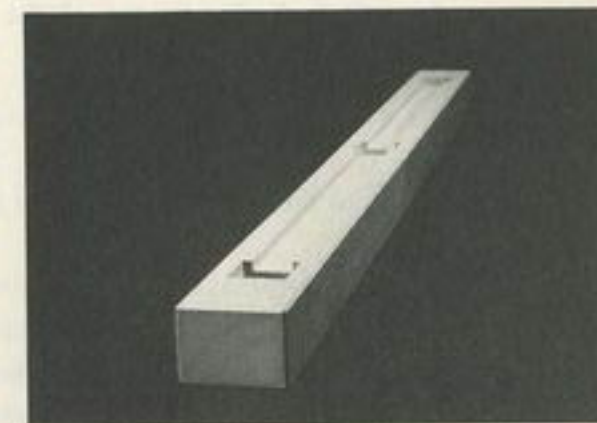
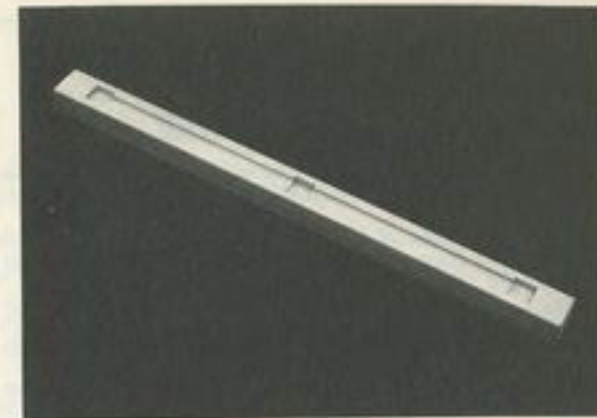

● MISCELLANEOUS 03 ●

Batter post

The batter posts are used on frames on which lines are taut as reference level. The post is tapered to a point at one end to make it easy to drive into the ground. The other end is crossbilled shaped to facilitate checking of vertical displacements of the posts.

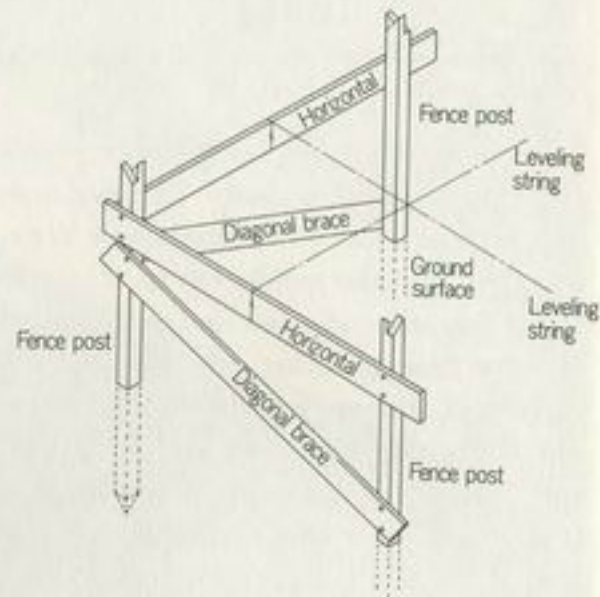
**Terminology**

Several systems exist for designating joints. The terminology is not standardized. As pointed out in the authors' comments, this book aims at describing a wide variety of splices and joints, describing them in detail. However, no pretense is made of giving an accurate designation for all of the joints, nor do we try to explain the origin of the appellations selected.

The following terminology should provide some help in understanding the technical terms employed.

Beam (hari): horizontal structural element which receives loading from a roof or a floor and transmits it to the columns.

Girder (keta): horizontal structural element within the framework of the external wall perpendicular to the tie-beam.

Girt (dosashi): horizontal structural element within the framework of the external wall intersecting the second floor beam perpendicularly.

Eave socket (udegi): Bracket anchoring the eave rafters onto a beam or a girder. When the eave rafters are not braced perpendicularly, the eave socket must be designed to carry a moment (cantilever eave rafter).

Hanging post (tsurizuka): Hanging posts are used to suspend the lintel from a beam or girder when column height exceeds 2.7m.

Tie (nuki): Bracing element within the internal framework of a wall running between columns.

Male-female: The positive and negative part of a splice or joint.

Upper wood-lower wood: In connection with joints, the upper and lower wood refer to two identical ends of a splice or a joint. When assembling the joint, the part which is joined onto the end already in place is called upper wood. The other end is the lower wood.

Example: Rabbeted oblique scarf splices and oblique scarf stub tenon

Stub tenon (daimochi): When the lower wood is meant to be exposed to the vertical load from the upper wood over the entire section of the joint, the assembly is called stub tenon.

Example: Blind stub tenon and tie stub tenon

Stepped joint (koshikake): When the male end of a joint is stepped to transmit a vertical load onto the female, or vice versa, the joint is said to be stepped.

Example: Stepped dovetail splice and stepped gooseneck splice

Dovetail (ari): The part of a joint shaped like the tail of a dove, narrow at the girth then flaring out.

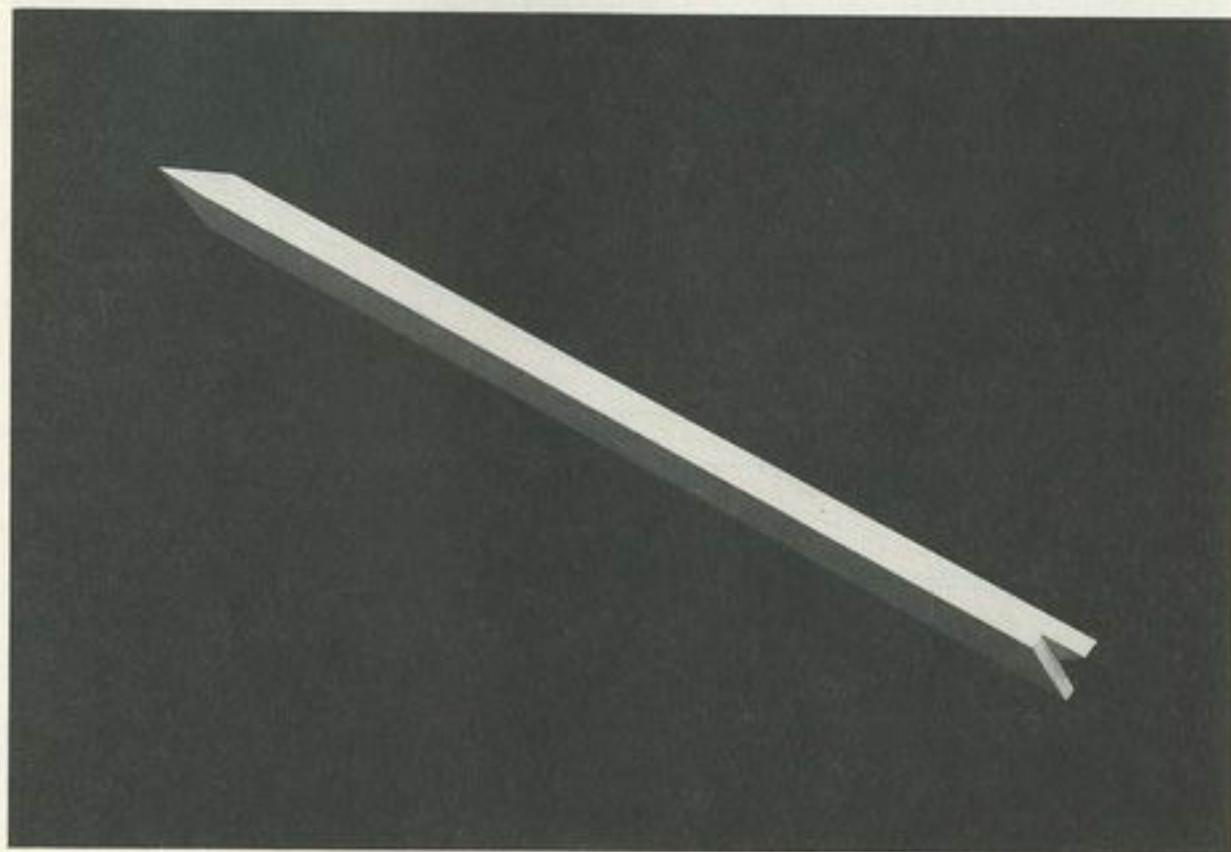

Example: Dovetailed splice, housed dovetail splice and halved dovetail

Tenon (hozo): A projection at the end of the male part of a joint.

Example: True tenon and mortise, rabbeted tenon, dovetailed tenon, blind wedged tenon

Gooseneck (kama): Refers to the ribbed end of a long tenon.

Example: Stepped gooseneck with tenon and mortise and square stepped gooseneck with tenon and mortise

Tongue and groove/tongue (mechiire-mechihozo): Refers to the joining of two elements. A long and narrow tenon (tongue) covers the length of the end surface of the male; an equivalent groove is carved on the end surface of the female.

Blind joint (hako): Refers to an encased tenon shaped like the letter "L" or the Japanese kana "コ" (ko).

Example: Blind tenon and mortise, blind stub tenon, blind pin and blind splice

Crossbilled or halved joint (isuka): Refers to a joint where the male and female are shaped like the beak of a crossbill finch.

Example: Halved rabbeted oblique scarf splice, triple-faced and quadruple-faced rabbeted oblique scarf splice, Miyajima splice

Miter joint (tome): When an inclined seam is located at the intersection of two members, the seam is called miter.

Drawpin (komisen): Two types of drawpin are used to tighten a joint. Some pins work in shear (type A) the other type withstand crushing pressure (type B)

Example:

A) rabbeted oblique scarf splice, double-faced plug, triple-faced plug

B) Mortise rabbeted oblique scarf splice, housed rabbeted oblique scarf splice, blind pin

Key (shachi): Locking element inserted into a key hole through the sections under shear.

Example: triple-faced halved joint, Miyajima, blind stub tenon, corridor girder, etc.

Wedge (kusabi): Tapered triangular element pounded between two surfaces, driving them apart from each other.

Example: wedged through halved dovetail, blind wedging joint, wedging joint, etc.

Dowel (dabo): Encased element inserted into a cavity passing through two joining surfaces. Example: stub tenon on ties